

THIS DOCUMENT IS SUBJECT TO CHANGE WITHOUT NOTICE. IT IS CONFIDENTIAL AND A PROPERTY OF AMPHENOL LTW. DISCLOSURE TO THIRD PARTY HAS TO BE AUTHORIZED BY AMPHENOL LTW.

REV.	ECN NO.	DATE	SIGN	DESCRIPTION
C	C180527	2018/11/28	Mafei	Adding 4 Pin Drawing.
D	C191385	2019/08/02	Siou	Revise Rated Voltage.
E	E191814	2019/10/24	Ruru	$\triangle E$ X3

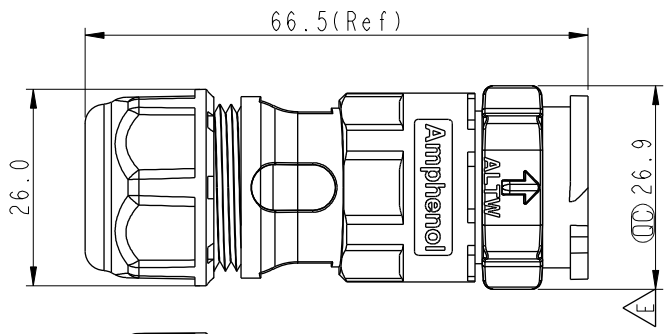
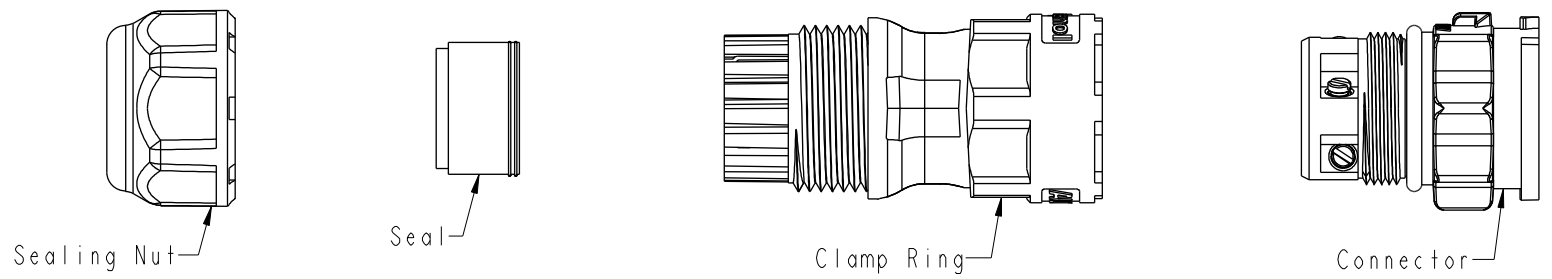

DC-XXBMMB-QL8XPP

$\triangle C$ 02-2 Pin
 03-3 Pin
 04-4 Pin
 05-5 Pin

S: With Red Color Seal 1, Cable OD 8.0~10.0mm.
 M: With Yellow Color Seal 2, Cable OD 10.0~12.0mm.
 L: With Blue Color Seal 3, Cable OD 12.0~14.0mm.
 A: With Seal 1 & Seal 2 & Seal 3.

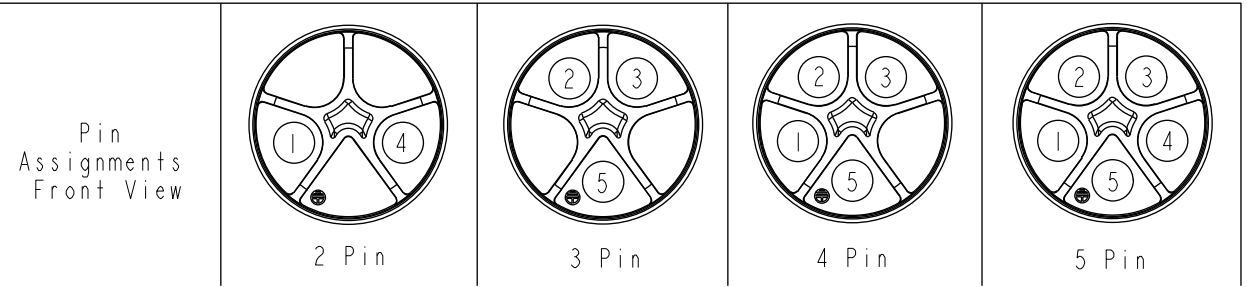
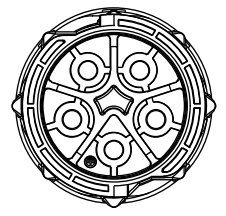
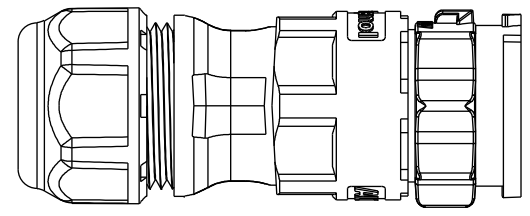

- $\triangle E$ Note:
- * \varnothing Important Dimension
 - * Waterproof Rate: IP68, Mated
IP68 : 1M Depth Of Water In 24hours
 - * Housing: Thermoplastic, Black
 - * Pin: Copper Alloy, Gold Plated
 - * Clamp Ring: Thermoplastic, Black
 - * Sealing Nut: Thermoplastic, Black
 - * Seals: Rubber

UNIT:mm		TITLE		Amphenol LTW	ITEM NO	DRAWN BY	DATE
		XLOK, D-20A, 03P, CABLE W/O SR M, M, FI SCREW IN, XLOK $\triangle E$					
TOLERANCE		SCALE	SIZE	安費諾亮泰企業股份有限公司	DWG NO	CHECKED BY	DATE
± 0.5 mm		8:5	A4		DC-XXBMMB-QL8XPP	Eagle	2019-08-02
		REV.	WC-REV.	ALTW	CUSTOMER	APPROVED BY	DATE
		E	A.3		ALTW	Neo	2019-08-02

THIS DOCUMENT IS SUBJECT TO CHANGE WITHOUT NOTICE. IT IS CONFIDENTIAL AND A PROPERTY OF Amphenol LTW. DISCLOSURE TO THIRD PARTY HAS TO BE AUTHORIZED BY Amphenol LTW.

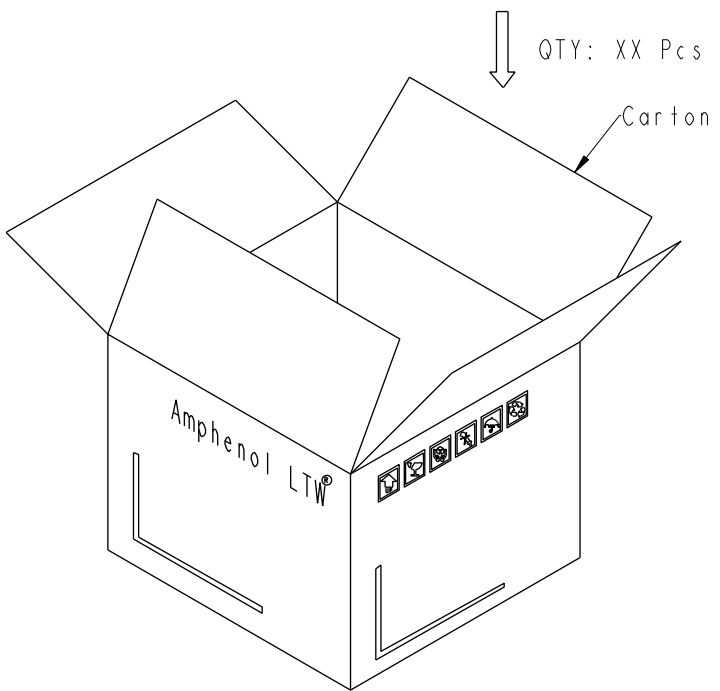
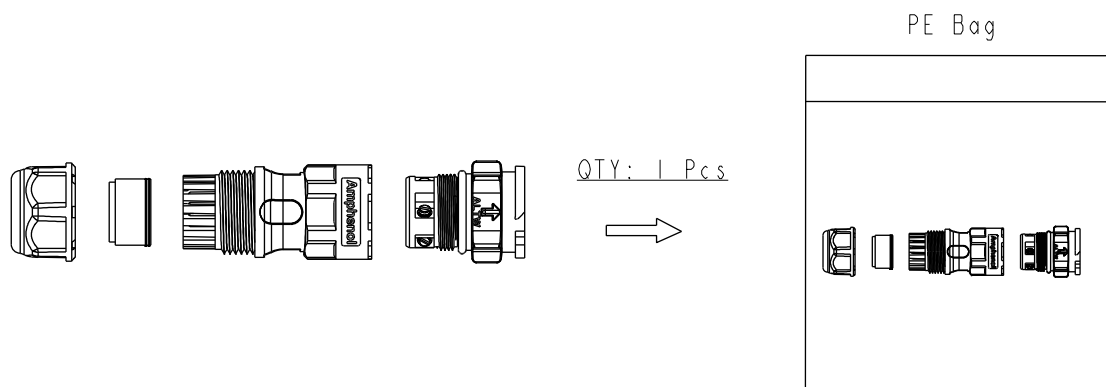

Note:
 * One Set Unassembled In One PE Bag.
 (每一組未組裝, 放置於一個PE袋, 並封口, 如圖示)
 △ * Label is Attached To PE Bag Front.
 (標籤貼在PE袋正面)

UNIT:mm	
TOLERANCE ±0.5 mm	

TITLE XLOK, D-20A, 03P, CABLE W/O SR M, M, FI SCREW IN, XLOK			
SCALE 8:5	SIZE A4	SHEET 2 OF 2	
REV. E	WC-REV. A.3	QC: Inspection item	

Amphenol LTW
 安費諾亮泰企業股份有限公司

ITEM NO	DRAWN BY Siou	DATE 2019-08-02
DWG NO DC-XXBMMB-QL8XPP	CHECKED BY Eagle	DATE 2019-08-02
CUSTOMER ALTW	APPROVED BY Neo	DATE 2019-08-02