

TCR05B102MGS

TCR Indust COG HT260C, Ceramic, 1000 pF, 20%, 50 VDC, COG, Commercial, High Temperature, Lead Spacing = 5.08mm

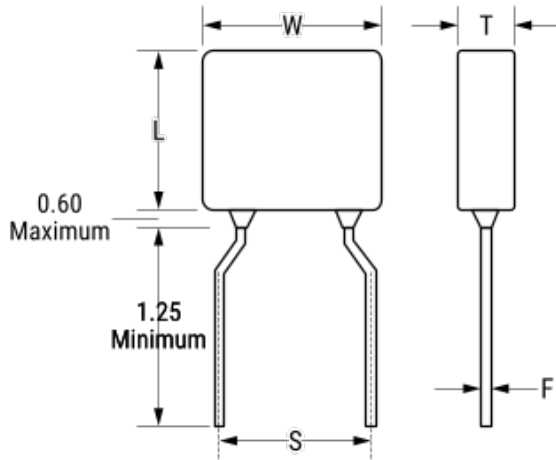

Click [here](#) for the 3D model.

Dimensions

L	5.08mm MAX
W	5.08mm MAX
T	2.54mm MAX
S	5.08mm +/-0.76mm
LL	3.175mm MIN
F	0.508mm +/-0.051mm

Packaging Specifications

Packaging	Bulk, Bag
Packaging Quantity	1

General Information

Series	TCR Indust COG HT260C
Style	Radial
Description	Commercial, High Temperature
Features	Commercial
RoHS	With Exemptions
REACH	SVHC (Pb - CAS 7439-92-1)
SCIP Number	a5a9e204-6d6a-49c3-acf7-37d0b4e9df91
Termination	Gold
Failure Rate	N/A
Testing and Reliability	Standard
AEC-Q200	No

Specifications

Capacitance	1000 pF
Capacitance Tolerance	20%
Voltage DC	50 VDC
Dielectric Withstanding Voltage	125 VDC
Temperature Range	-55/+260°C
Temperature Coefficient	COG
Dissipation Factor	0.15% 1 kHz 1.0Vrms
Insulation Resistance	100 GOhms