

## WR-102 Standard Gain Horn with 20 dBi gain, N Male connector

### Technical Data Sheet

### PEWAN102-20NM

#### Features

- 7 GHz to 11 GHz
- WR-102 Waveguide Band
- 20 dBi Nominal Gain
- N Male Connector

#### Applications

- Antenna Measurements
- Wireless Communication
- Laboratory Use
- Microwave Radio Systems
- Radome Testing
- Automotive Antenna Test
- Solutions
- Radar Cross Section
- Satellite Antenna Testing

#### Description

The PEWAN102-20NM standard gain horn antenna (also known as waveguide horn) from Pasternack is part of our comprehensive selection of waveguide antennas. This standard gain horn is mated with a WR-102 to N Male waveguide to coaxial adapter and operates from 7 GHz to 11 GHz.

Our PEWAN102-20NM standard gain horn antenna has a nominal gain of 20 dBi with a Horizontal and Vertical HPBW (Half Power Beam Width) of 17.5 dB and 17.3 dB respectively. Pasternack's N Male to WR-102 standard gain horns are available in 10, 15 and 20 dBi models with pyramidal shape and connectorized input.

Waveguide antennas, such as the PEWAN102-20NM are used in a wide variety of applications due to the high-power handling capability, low loss, high directivity, and near constant electrical performance. Our WR-102 waveguide antennas with N Male interface is part of over 40,000 RF, microwave and millimeter wave components from Pasternack available worldwide and Ship same day.

#### Configuration

Design: WR-102 Standard Gain Horn  
Coaxial Interface: N Male

#### Electrical Specifications

Description	Minimum	Typical	Maximum	Units
Frequency Range	7		11	GHz
<b>Waveguide Standard Gain Horn</b>				
Gain		20		dBi
Horizontal Half Power Beam Width		17.5		Degrees
Vertical Half Power Beam Width		17.3		Degrees
<b>Waveguide to Coaxial Adapter</b>				
Input VSWR			1.3:1	

Click the following link (or enter part number in "SEARCH" on website) to obtain additional part information including price, inventory and certifications: [WR-102 Standard Gain Horn with 20 dBi gain, N Male connector PEWAN102-20NM](#)

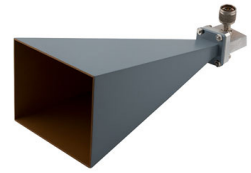

WR-102 Standard Gain Horn with 20 dBi gain, N Male connector

## Technical Data Sheet

**PEWAN102-20NM**

### Mechanical Specifications

#### Size

Length	12.713 in [322.91 mm]
Width	4.988 in [126.7 mm]
Height	3.701 in [94.01 mm]
Weight	1.083 lbs [491.24 g]

#### RF Connector

Type	N Male
------	--------

#### Waveguide Interface

Waveguide Size	WR-102
----------------	--------

### Environmental Specifications

**Compliance Certifications** (see [product page](#) for current document)

### Plotted and Other Data

Notes:

Click the following link (or enter part number in "SEARCH" on website) to obtain additional part information including price, inventory and certifications: [WR-102 Standard Gain Horn with 20 dBi gain, N Male connector PEWAN102-20NM](#)

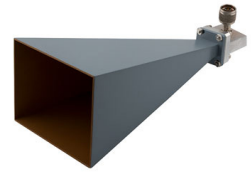

WR-102 Standard Gain Horn with 20 dBi gain, N Male connector

**Technical Data Sheet**

**PEWAN102-20NM**

Typical Performance Data

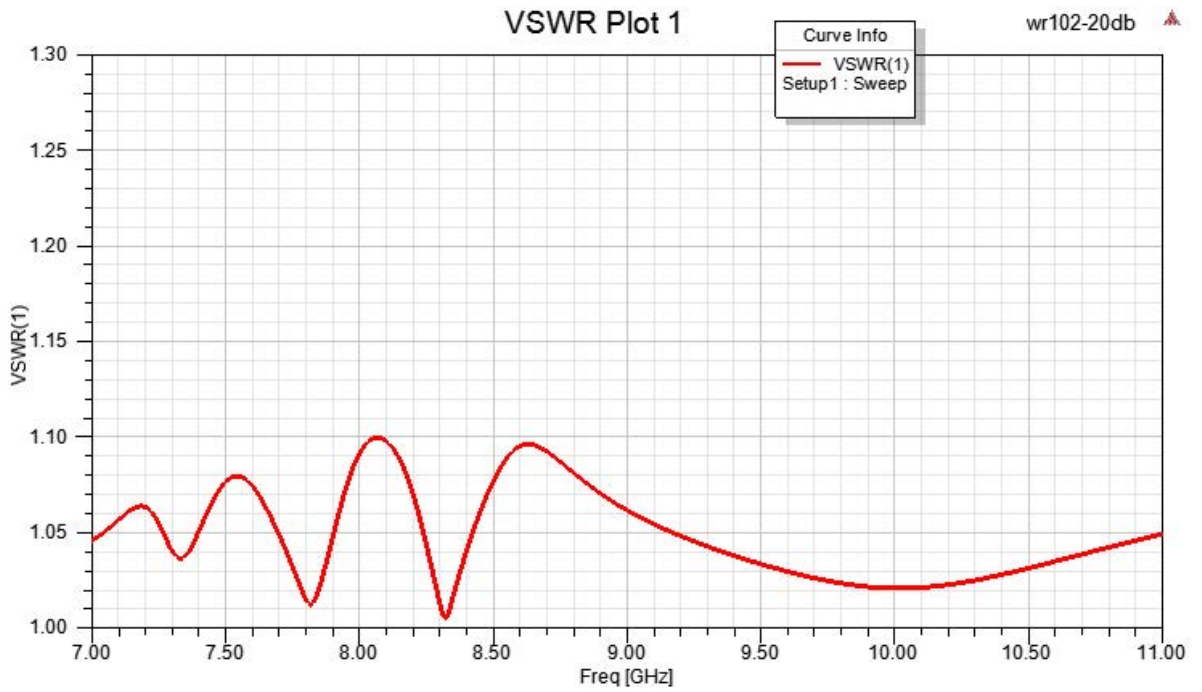

Click the following link (or enter part number in "SEARCH" on website) to obtain additional part information including price, inventory and certifications: [WR-102 Standard Gain Horn with 20 dBi gain, N Male connector PEWAN102-20NM](#)

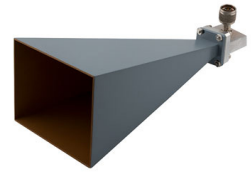

WR-102 Standard Gain Horn with 20 dBi gain, N Male connector

**Technical Data Sheet**

**PEWAN102-20NM**

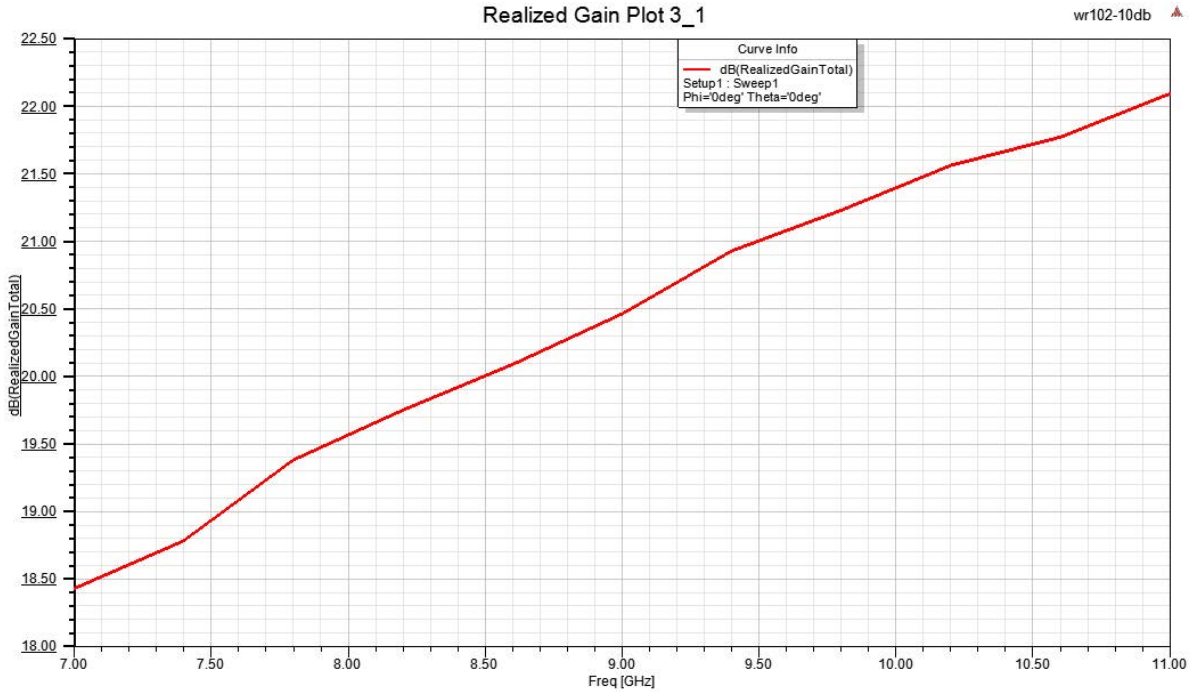

Click the following link (or enter part number in "SEARCH" on website) to obtain additional part information including price, inventory and certifications: [WR-102 Standard Gain Horn with 20 dBi gain, N Male connector PEWAN102-20NM](#)

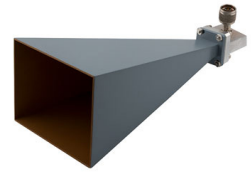

WR-102 Standard Gain Horn with 20 dBi gain, N Male connector

**Technical Data Sheet**

**PEWAN102-20NM**

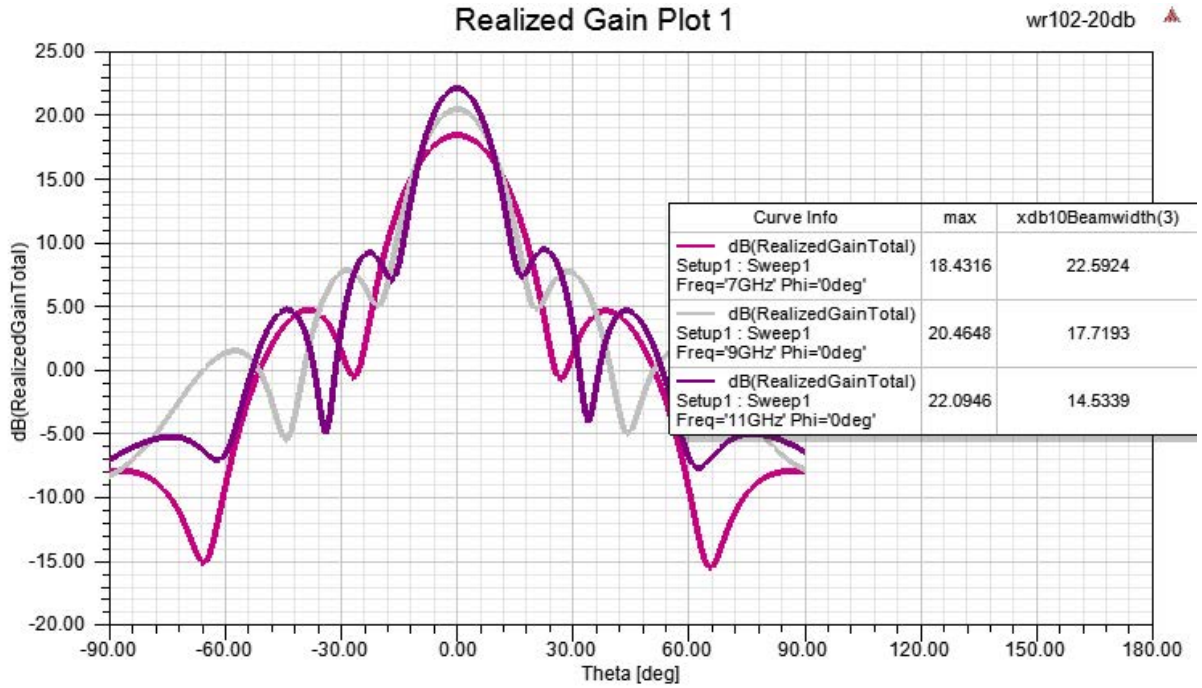

Click the following link (or enter part number in "SEARCH" on website) to obtain additional part information including price, inventory and certifications: [WR-102 Standard Gain Horn with 20 dBi gain, N Male connector PEWAN102-20NM](#)

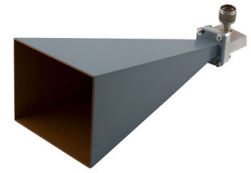

WR-102 Standard Gain Horn with 20 dBi gain, N Male connector

**Technical Data Sheet**

**PEWAN102-20NM**

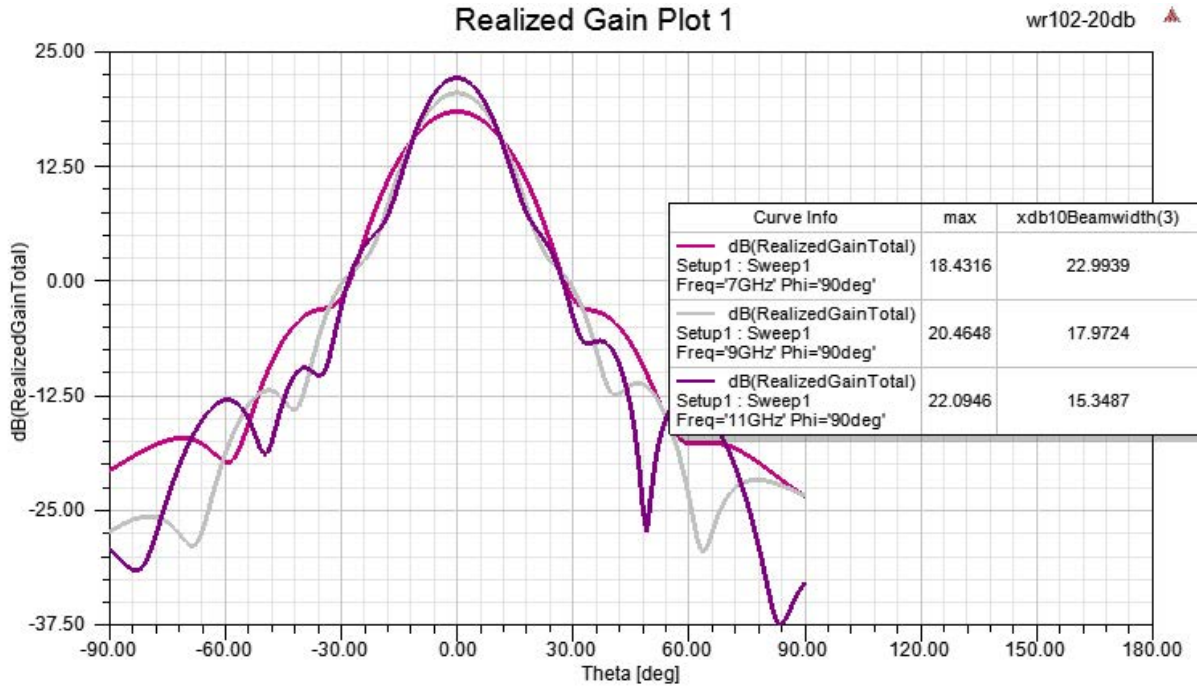

WR-102 Standard Gain Horn with 20 dBi gain, N Male connector from Pasternack Enterprises has same day shipment for domestic and International orders. Our RF, microwave and millimeter wave products maintain a 99.4% availability and are part of the broadest selection in the industry.

Click the following link (or enter part number in "SEARCH" on website) to obtain additional part information including price, inventory and certifications: [WR-102 Standard Gain Horn with 20 dBi gain, N Male connector PEWAN102-20NM](#)

URL:

The information contained in this document is accurate to the best of our knowledge and representative of the part described herein. It may be necessary to make modifications to the part and/or the documentation of the part, in order to implement improvements. Pasternack reserves the right to make such changes as required. Unless otherwise stated, all specifications are nominal. Pasternack does not make any representation or warranty regarding the suitability of the part described herein for any particular purpose, and Pasternack does not assume any liability arising out of the use of any part or documentation.

# PEWAN102-20NM CAD Drawing

WR-102 Standard Gain Horn with 20 dBi gain, N Male connector

REVISIONS			
REV.	DESCRIPTION	DATE	APPROVED
A	INITIAL RELEASE	01/11/2022	KHIETPAS

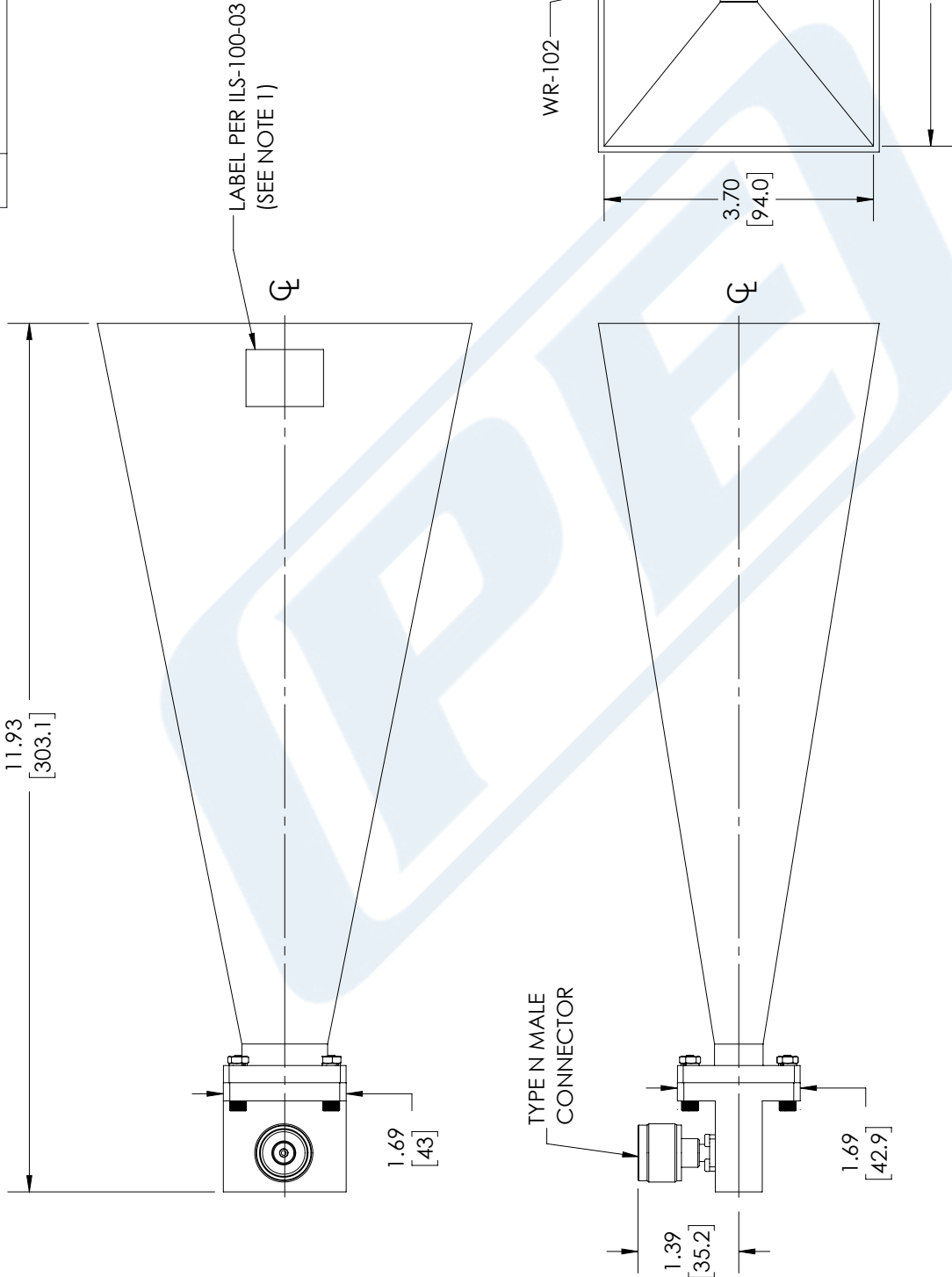

**PE PASTERNAK**  
an INFINITI brand

Pasternack Enterprises, Inc.  
P. O. Box 16759, Irvine, CA 92623.  
Phone: 1.949.261.1920 | 1.866.727.8376  
Fax: 1.949.261.7451  
Website: www.pasternack.com  
E-mail: sales@pasternack.com

THIRD-ANGLE PROJECTION

THE INFORMATION AND DESIGN IN THIS DOCUMENT IS THE PROPERTY OF PASTERNAK CORPORATION. ALL RIGHTS RESERVED.

SHEET 1 OF 1  
SCALE N/A

---

UNLESS OTHERWISE SPECIFIED LEADING DIMENSIONS ARE INCHES DIMENSIONS IN [ ] ARE MILLIMETERS

TOLERANCES:

.X = ±.2	[.08]	FRACTIONS
.XX = ±.02	[.51]	± 1/32
.XXX = ±.005	[.13]	ANGLES ± 1°

CABLE LENGTH (L) TOLERANCES:

L ≤ 12	[305]	= +1 [25] / -0
12 [305] < L ≤ 60	[1524]	= +2 [51] / -0
60 [1524] < L ≤ 120	[3048]	= +4 [102] / -0
120 [3048] < L ≤ 300	[7620]	= +6 [152] / -0
300 [7620] < L		= +5%L / -0

ALL DIMENSIONS SHOWN ARE FOR REFERENCE ONLY.

ITEM NO. PEWAN102-20NM

REV A

CAGE CODE 53919

DRAWN BY BPUCHASKI

**NOTES:**  
1. LABEL PER ILS-100-03 (FOR INTERNAL REFERENCE ONLY)  
LABEL LOCATION FOR REFERENCE ONLY

THESE COMMODITIES, TECHNOLOGY OR SOFTWARE WERE EXPORTED FROM THE UNITED STATES IN ACCORDANCE WITH THE EXPORT ADMINISTRATION REGULATIONS. DIVERSION CONTRARY TO U.S. LAW PROHIBITED.