

Product Datasheet

40G-QSFP-QSFP-AOC-15M-C

Brocade® Compatible 40GBASE-SR4 QSFP+ Active Optical Cable, Active, 15m

FEATURES

- QSFP MSA compliant
- Four-channel full-duplex active optical cable
- Transmission data rate up to 11.3Gbit/s per channel
- Reliable VCSEL array technology using multimode fiber
- Available in standard lengths of 3, 5, 10, 15, 20, 30, 50, 100m
- Low power consumption <1.5W
- Operating case temperature 0°C to +70°C
- 3.3V power supply voltage
- RoHS 6 compliant
- Hot Pluggable QSFP form factor

APPLICATIONS

- Infiniband QDR/DDR/SDR
- Datacenter
- 40G Ethernet
- 4G/8G/10G Fibre Channel

DESCRIPTION

ATGBICS 40G-QSFP-QSFP-AOC-15M-C QSFP+ active optical cables are a high performance, low power consumption, long reach interconnect solution supporting InfiniBand QDR/DDR/SDR, 12.5G/10G/8G/4G/2G fiber channel, PCIe and SAS. It is compliant with the QSFP MSA and IEEE P802.3ba. WAREX QSFP AOC is an assembly of 4 full-duplex lanes, where each lane is capable of transmitting data at rates up to 11.3Gb/s, providing an aggregated rate of 45.2Gb/s. WAREX QSFP+ AOC is one kind of parallel transceiver which provides increased port density and total system cost savings.

Product Datasheet

Absolute Maximum Ratings

Parameter	Symbol	Min	Max	Unit
Storage Temperature	TST	-40	85	degC
Relative Humidity(non-condensing)	RH	0	85	%
Operating Case Temperature	TOPC	0	70	degC
Supply Voltage	VCC	-0.3	3.6	V
Input Voltage	Vin	-0.3	Vcc+0.3	V

Note:

1. The operation in excess of any absolute maximum ratings might cause permanent damage to this module

Recommended Operating Conditions and Supply Requirements

Parameter	Symbol	Min	Typical	Max	Unit
Operating Case Temperature	TOPC	0		70	degC
Power Supply Voltage	VCC	3.13	3.3	3.47	V
Power Consumption		-		1.5	W
Data Rate	DR	1	10.3	11.3	Gbps
Data Speed Tolerance	Δ DR	-100		+100	ppm
Link Distance with OM3 fiber	D	0		100	m

Product Datasheet

Electrical Specifications

Parameter	Symbol	Min	Typical	Max	Unit
Differential input impedance	Zin	90	100	110	ohm
Differential Output impedance	Zout	90	100	110	ohm
Differential input voltage amplitude	ΔV_{in}	300		1100	mVp-p
Differential output voltage amplitude	ΔV_{out}	500		800	mVp-p
Bit Error Rate	BR			E-12	
Input Logic Level High	V _{IH}	2.0		V _{CC}	V
Input Logic Level Low	V _{IL}	0		0.8	V
Output Logic Level High	V _{OH}	V _{CC} -0.5		V _{CC}	V
Output Logic Level Low	V _{OL}	0		0.4	V

Product Datasheet

Pin Descriptions

PIN	Logic	Symbol	Name/Description	Note
1		GND	Ground	1
2	CML-I	Tx2n	Transmitter Inverted Data Input	
3	CML-I	Tx2p	Transmitter Non-Inverted Data output	
4		GND	Ground	1
5	CML-I	Tx4n	Transmitter Inverted Data Input	
6	CML-I	Tx4p	Transmitter Non-Inverted Data output	
7		GND	Ground	1
8	LVTLL-I	ModSelL	Module Select	
9	LVTLL-I	ResetL	Module Reset	
10		VccRx	+ 3.3V Power Supply Receiver	2
11	LVC MOS-I/O	SCL	2-Wire Serial Interface Clock	
12	LVC MOS-I/O	SDA	2-Wire Serial Interface Data	
13		GND	Ground	
14	CML-O	Rx3p	Receiver Non-Inverted Data Output	
15	CML-O	Rx3n	Receiver Inverted Data Output	
16		GND	Ground	1
17	CML-O	Rx1p	Receiver Non-Inverted Data Output	
18	CML-O	Rx1n	Receiver Inverted Data Output	
19		GND	Ground	1
20		GND	Ground	1
21	CML-O	Rx2n	Receiver Inverted Data Output	
22	CML-O	Rx2p	Receiver Non-Inverted Data Output	

Product Datasheet

23		GND	Ground	1
24	CML-O	Rx4n	Receiver Inverted Data Output	1
25	CML-O	Rx4p	Receiver Non-Inverted Data Output	
26		GND	Ground	1
27	LVTTL-O	ModPrsL	Module Present	
28	LVTTL-O	IntL	Interrupt	
29		VccTx	+3.3 V Power Supply transmitter	2
30		Vcc1	+3.3 V Power Supply	2
31	LVTTL-I	LPMode	Low Power Mode	
32		GND	Ground	1
33	CML-I	Tx3p	Transmitter Non-Inverted Data Input	
34	CML-I	Tx3n	Transmitter Inverted Data Output	
35		GND	Ground	1
36	CML-I	Tx1p	Transmitter Non-Inverted Data Input	
37	CML-I	Tx1n	Transmitter Inverted Data Output	
38		GND	Ground	1

Notes:

1. Module circuit ground is isolated from module chassis ground within the module. GND is the symbol for signal and supply (power) common for QSFP modules
2. The connector pins are each rated for a maximum current of 500mA

Product Datasheet

Power Supply Filtering

The host board should use the power supply filtering shown in Figure1

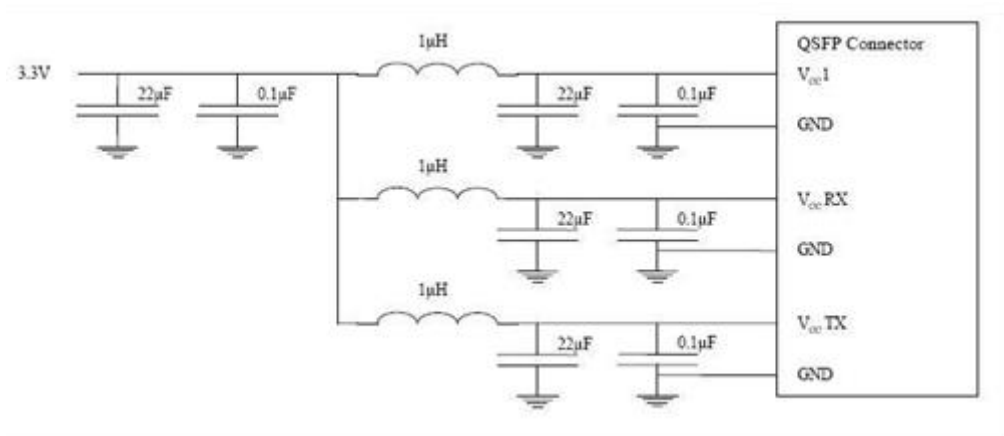

Figure1. Host Board Power Supply Filtering

Product Datasheet

EEPROM Serial ID Memory Contents:

Serial ID: Data Fields (Page 00)

Address	Size (Bytes)	Name	Description of Base ID Field	Optical Module
128	1	Identifier	Identifier Type of serial Module	R
129	1	Ext. Identifier	Extended Identifier of Serial Module	R
130	1	Connector	Code for connector type	R
131-138	8	Specification compliance	Code for electronic compatibility or optical	R
139	1	Encoding	Code for serial encoding algorithm	R
140	1	BR, nominal	Nominal bit rate, units of 100 Mbits/s	R
141	1	Extended rate select Compliance	Tags for extended rate select compliance	R
142	1	Length (SMF)	Link length supported for SMF fiber in km (note 1)	R
143	1	Length (OM3 50um)	Link length supported for EBW 50/125 um fiber (OM3),	R
144	1	Length (OM2 50um)	Link length supported for 50/125 um fiber (OM2), units of 1m (note 1)	R
145	1	Length (OM1 62.5um)	Link length supported for 62.5/125 um fiber (OM1), units of 1m (note 1)	R
146	1	Length (Copper)	Link length of copper or active cable, units of 1m (note 1) Link length	R
147	1	Device tech	Device technology	R
148-163	16	Vendor name	QSFP+ vendor name (ASCII)	R
164	1	Extended Module	Extended Module codes for InfiniBand	R
165-167	3	Vendor OUI	QSFP+ vendor IEEE company ID	R
168-183	16	Vendor PN	Part number provided by QSFP+ vendor (ASCII)	R

Product Datasheet

184-185	2	Vendor rev	Revision level for part number provided by vendor (ASCII)	R
186-187	2	Wavelength or Copper cable Attenuation	Nominal laser wavelength (wavelength=value/20 in nm) or copper cable	R
188-189	2	Wavelength tolerance	Guaranteed range of laser wavelength (+/- value) from nominal wavelength. (Wavelength Tol. = value/200 in nm)	R
190	1	Max case temp.	Maximum case temperature in degrees C	R
191	1	CC_BASE	Check code for base ID fields (addresses 128-190)	R
192-195	4	Options	Rate Select, TX Disable, TX Fault, LOS, Warning indicators for: Temperature, VCC, RX power, TX Bias	R
196-211	16	Vendor SN	Serial number provided by vendor (ASCII)	R
212-219	8	Date Code	Vendor's manufacturing date code	R
220	1	Diagnostic Monitoring Type	Indicates which types of diagnostic monitoring are implemented (if any) in the Module. Bit 1,0 Reserved	R
221	1	Enhanced Options	Indicates which optional enhanced features are implemented in the Module.	R
222	1	Reserved		
223	1	CC_EXT	Check code for the Extended ID Fields (addresses 192-222)	R
Vendor Specific ID Fields				
224-255	32	Vendor Specific EEPROM		

Product Datasheet

Mechanical Information



Ordering Information

Length	Note
3m	OM3 Cable
5m	OM3 Cable
10m	OM3 Cable
20m	OM3 Cable
30m	OM3 Cable
50m	OM3 Cable
70m	OM3 Cable
100m	OM3 Cable