

# Relay Module - RIF-1-RPT-LV-230AC/2X21MS - 2905292

Please be informed that the data shown in this PDF Document is generated from our Online Catalog. Please find the complete data in the user's documentation. Our General Terms of Use for Downloads are valid (<http://phoenixcontact.com/download>)



Pre-assembled relay module with push-in connection, consisting of: relay base, relay retaining bracket, plug-in suppressor module, and power contact relay with test button and integrated status LED. Contact type: 2 PDTs. Input voltage: 230 V AC



## Key Commercial Data

Packing unit	10 pc
GTIN	
GTIN	4046356945387

## Technical data

### Note

Utilization restriction	EMC: class A product, see manufacturer's declaration in the download area
-------------------------	---

### Dimensions

Width	16 mm
Height	93 mm
Depth	75 mm

### Ambient conditions

Ambient temperature (operation)	-40 °C ... 45 °C
Ambient temperature (storage/transport)	-40 °C ... 85 °C
Degree of protection	IP20 (Relay base)
	RT II (Relay)

### Coil side

Nominal input voltage $U_N$	230 V AC (50/60 Hz)
Input voltage range in reference to $U_N$	see diagram
Mains frequency	50/60 Hz
Typical input current at $U_N$	3.5 mA

# Relay Module - RIF-1-RPT-LV-230AC/2X21MS - 2905292

## Technical data

### Coil side

Typical response time	4 ms ... 10 ms
Typical release time range	3 ms ... 20 ms
Coil voltage	230 V AC
Protective circuit	Varistor
Operating voltage display	Yellow LED
Power dissipation for nominal condition	0.81 W

### Contact side

Contact type	2 PDT
Type of switch contact	Single contact
Contact material	AgNi
Maximum switching voltage	250 V AC/DC
Minimum switching voltage	12 V (at 10 mA)
Min. switching current	10 mA (at 12 V)
Maximum inrush current	16 A (20 ms, N/O contact)
Limiting continuous current	see diagram
Interrupting rating (ohmic load) max.	192 W (at 24 V DC)
	62 W (at 48 V DC)
	42 W (at 60 V DC)
	55 W (at 110 V DC)
	66 W (at 220 V DC)
	2000 VA (for 250 V AC)
Switching capacity min.	120 mW
Switching capacity	1 A (at 24 V, DC13)
	1.5 A (at 230 V, AC15)

### General

Test voltage relay winding/relay contact	4 kV <sub>rms</sub> (50 Hz, 1 min.)
Test voltage PDT/PDT	2.5 kV <sub>rms</sub> (50 Hz, 1 min.)
Operating mode	100% operating factor
Mechanical service life	approx. 5x 10 <sup>6</sup> cycles
Service life, electrical	see diagram
Mounting position	any
Assembly instructions	In rows with zero spacing

### Connection data

Connection name	Coil side
Connection method	Push-in connection
Stripping length	8 mm
Conductor cross section solid	0.14 mm <sup>2</sup> ... 1.5 mm <sup>2</sup>
Conductor cross section flexible	0.14 mm <sup>2</sup> ... 1.5 mm <sup>2</sup>
	0.14 mm <sup>2</sup> ... 1.5 mm <sup>2</sup> (Ferrule with plastic sleeve)

# Relay Module - RIF-1-RPT-LV-230AC/2X21MS - 2905292

## Technical data

### Connection data

	0.14 mm <sup>2</sup> ... 1 mm <sup>2</sup> (Ferrule with plastic sleeve, two conductors on double terminal block)
Conductor cross section AWG	26 ... 16 (solid)
	26 ... 16 (flexible)

### Connection data 2

Connection name	Contact side
Connection method	Push-in connection
Stripping length	8 mm
Conductor cross section solid	0.14 mm <sup>2</sup> ... 1.5 mm <sup>2</sup>
Conductor cross section flexible	0.14 mm <sup>2</sup> ... 1.5 mm <sup>2</sup>
	0.14 mm <sup>2</sup> ... 1.5 mm <sup>2</sup> (Ferrule with plastic sleeve)
	0.14 mm <sup>2</sup> ... 1 mm <sup>2</sup> (Ferrule with plastic sleeve, two conductors on double terminal block)
Conductor cross section AWG	26 ... 16 (solid)
	26 ... 16 (flexible)

### Standards and Regulations

Standards/regulations	DIN EN 50178
Rated insulation voltage	250 V AC
Rated surge voltage	6 kV
Insulation	safe isolation
Pollution degree	2
Overvoltage category	III

### Environmental Product Compliance

China RoHS	Environmentally Friendly Use Period = 50
	For details about hazardous substances go to tab "Downloads", Category "Manufacturer's declaration"

## Drawings

# Relay Module - RIF-1-RPT-LV-230AC/2X21MS - 2905292

Circuit diagram

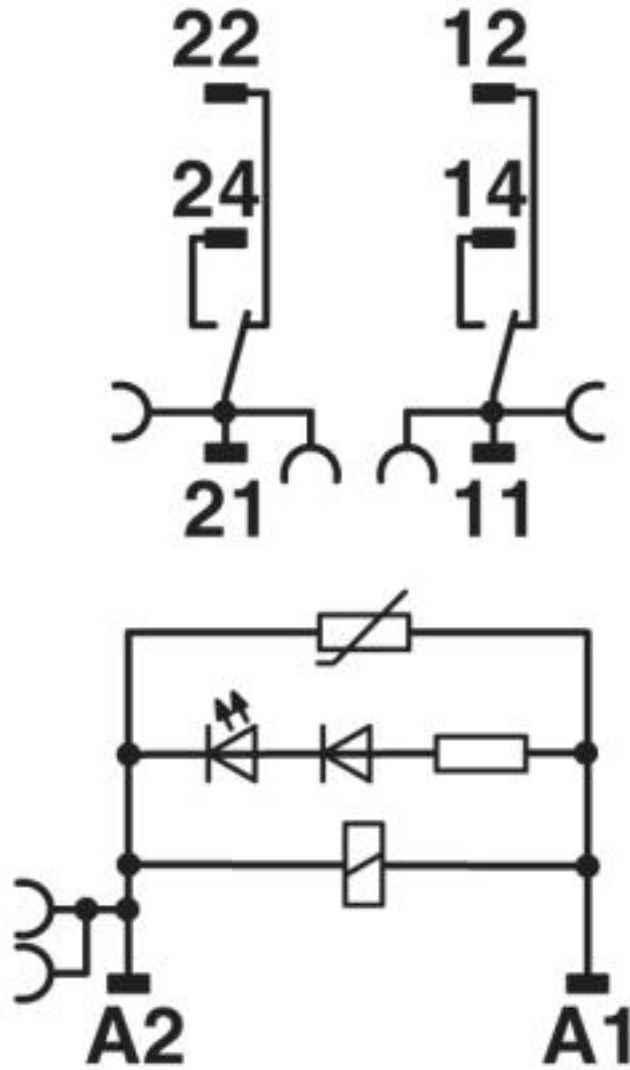

AC coils

# Relay Module - RIF-1-RPT-LV-230AC/2X21MS - 2905292

Diagram

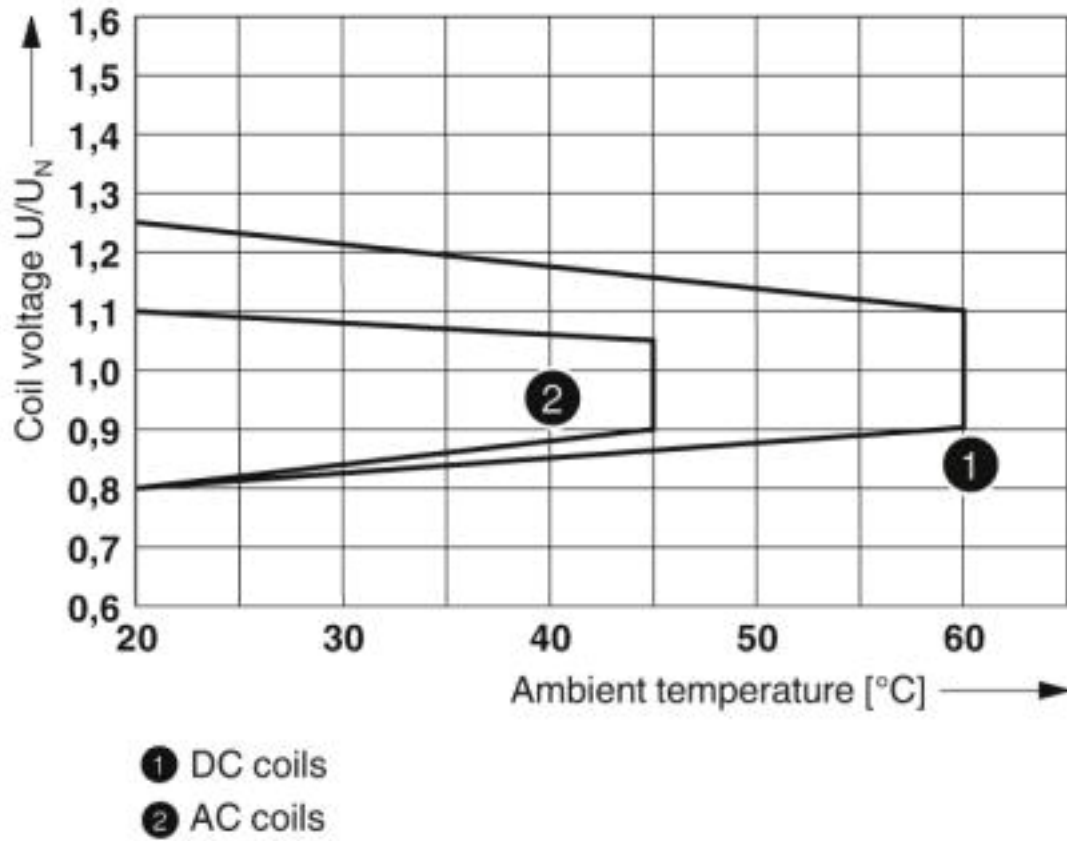

Operating voltage range

# Relay Module - RIF-1-RPT-LV-230AC/2X21MS - 2905292

Diagram

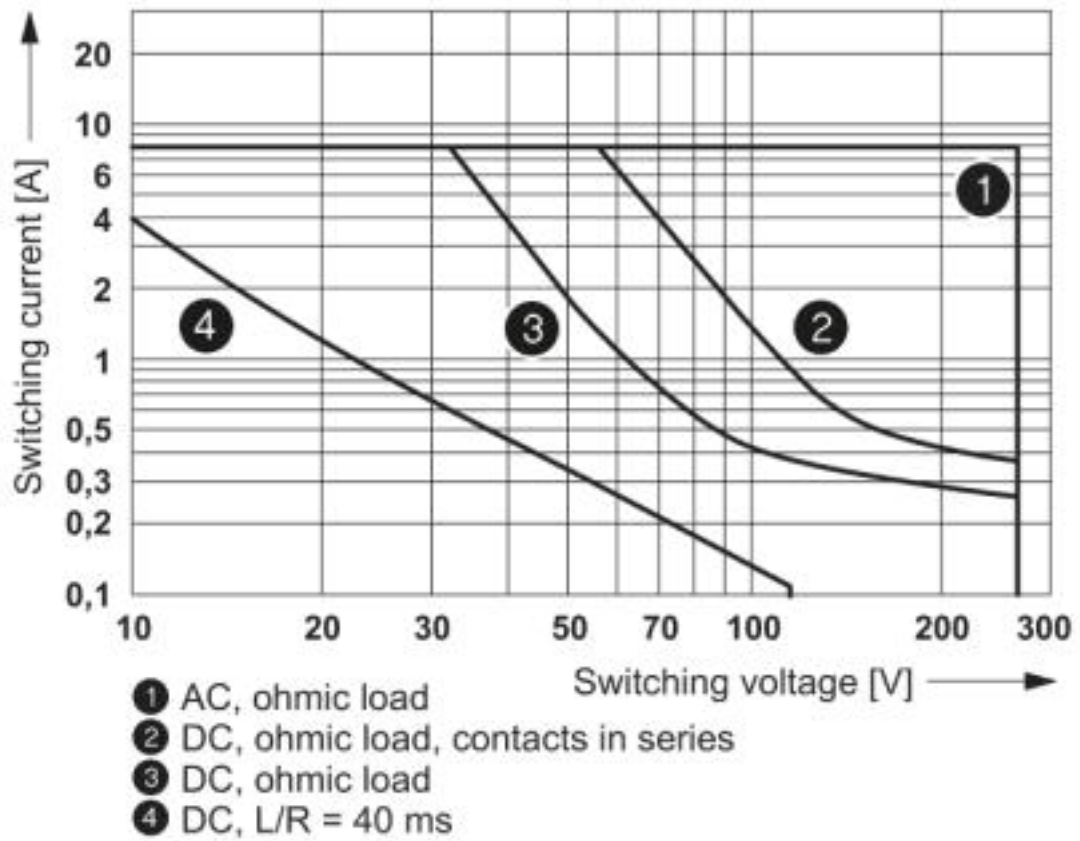

Interrupting rating

# Relay Module - RIF-1-RPT-LV-230AC/2X21MS - 2905292

Diagram

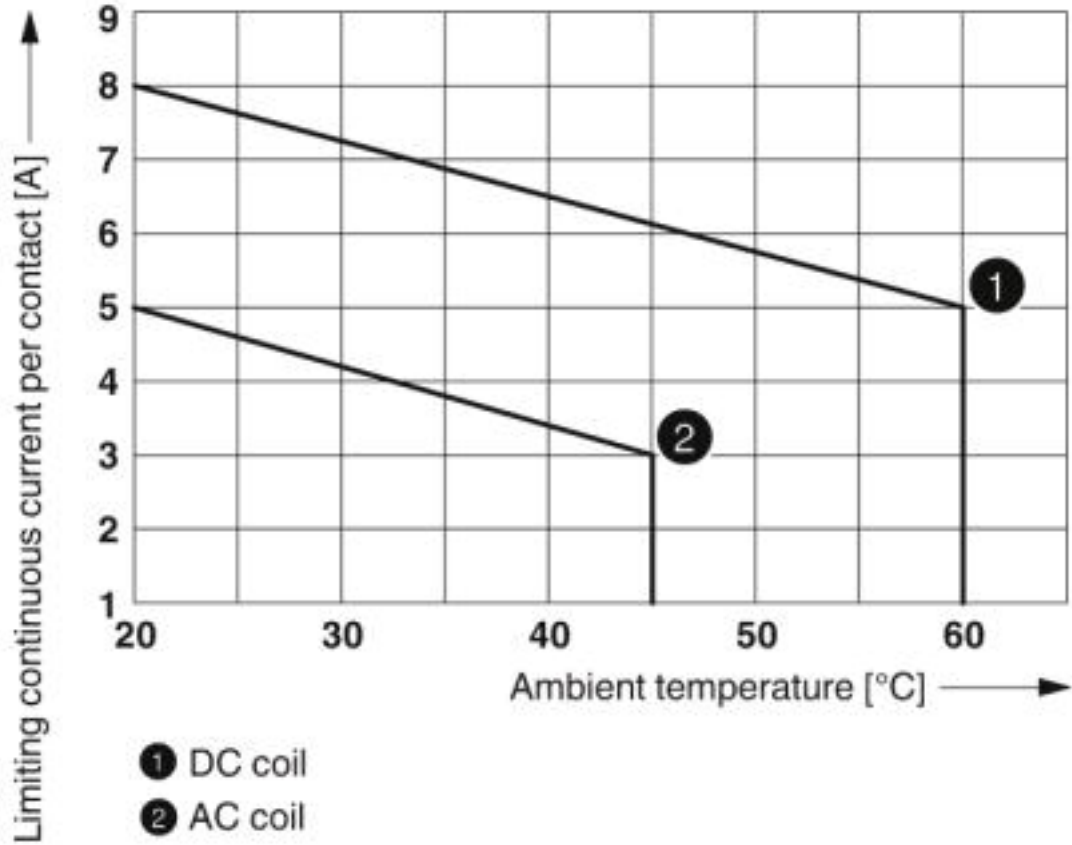

Contact derating

# Relay Module - RIF-1-RPT-LV-230AC/2X21MS - 2905292

Diagram

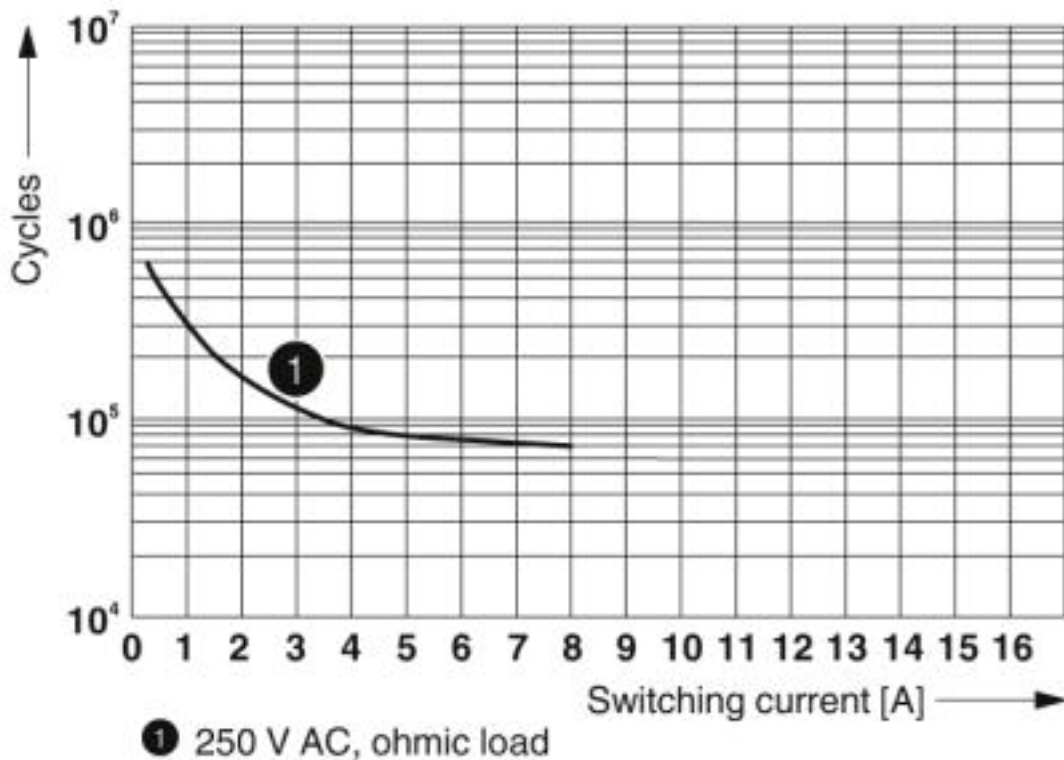

Electrical service life

Diagram

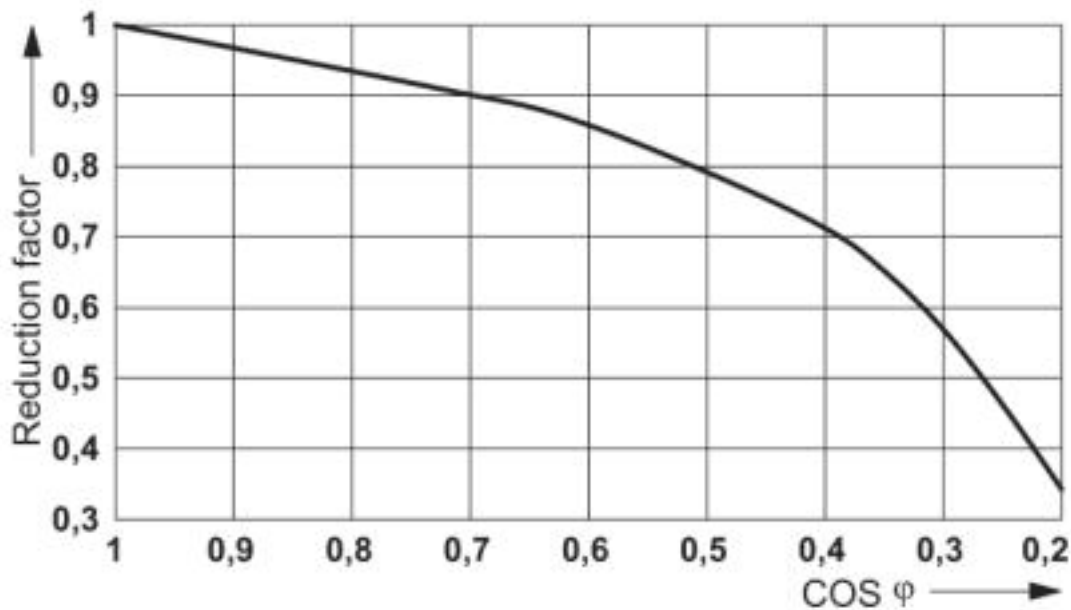

Service life reduction factor



## Relay Module - RIF-1-RPT-LV-230AC/2X21MS - 2905292

### Articles in set

Relay base - RIF-1-BPT/2X21 - 2900931



RIF-1... relay base, for miniature power relay with 1 or 2 PDTs or solid-state relays of the same design, push-in connection, plug-in option for input/suppressor modules, for mounting on NS 35/7,5

---

Single relay - REL-MR-230AC/21-21/MS - 2987972



Plug-in miniature relay, with power contact, 2 PDTs, test button, mechanical switch position indicator, status LED, coil voltage 230 V AC

---

Plug-in module - RIF-V-120-230 UC - 2900948



Plug-in module, for mounting on RIF-1, RIF-2, RIF-3, and RIF-4, with varistor, input voltage: 120 ... 230 V AC/DC  $\pm$ 20 %

---

Retaining bracket - RIF-RH-1-H - 2904468



Relay retaining bracket, with ejector function and holder for marking material, suitable for RIF-1 relay base, for 25 mm tall miniature power relay and solid-state relay

---

## Approvals

### Approvals

---

Approvals

DNV GL / EAC / EAC / EAC

---

Ex Approvals

---

### Approval details

## Relay Module - RIF-1-RPT-LV-230AC/2X21MS - 2905292

### Approvals

DNV GL		<a href="https://approvalfinder.dnvgl.com/">https://approvalfinder.dnvgl.com/</a>	TAA000018V
--------	---	---	------------

EAC			RU C- DE.A*30.B.01082
-----	---	--	--------------------------

EAC			TR_TS_S_00010_c
-----	---	--	-----------------

EAC			TR_TS_D_00573_c
-----	---	--	-----------------

Phoenix Contact 2019 © - all rights reserved  
<http://www.phoenixcontact.com>

PHOENIX CONTACT GmbH & Co. KG  
Flachsmarktstr. 8  
32825 Blomberg  
Germany  
Tel. +49 5235 300  
Fax +49 5235 3 41200  
<http://www.phoenixcontact.com>