

# HARWIN

## HAND CRIMP TOOL Z80-255



## Datamate **Trio-Tek**

This Hand Crimp Tool has been designed for use with the following Datamate Trio-Tek Signal Crimp Contacts:

- M80-25300XX ..... Female crimp contact for 22-24 AWG wire, supplied reeled
- M80-25400XX ..... Female crimp contact for 26-28 AWG wire, supplied reeled
- M80-25600XX ..... Female crimp contact for 22-24 AWG wire, supplied reeled
- M80-25700XX ..... Female crimp contact for 26-28 AWG wire, supplied reeled
- M80-28300XX ..... Female crimp contact for 22-24 AWG wire, supplied loose
- M80-28400XX ..... Female crimp contact for 26-28 AWG wire, supplied loose
- M80-29600XX ..... Female crimp contact for 22-24 AWG wire, supplied reeled
- M80-29700XX ..... Female crimp contact for 26-28 AWG wire, supplied reeled

Harwin recommend the use of BS 3G 210 Type A PTFE Equipment Wire or near equivalent.

Contact	Wire Gauge (AWG)	Typical Stranding (no of strands/ $\varnothing$ mm)	Conductor cross-sectional area (mm <sup>2</sup> )	Max Insulation diameter (mm)	Crimp height (mm)	Minimum pull-off force
M80-253/256/283/29600XX	22	19/0.15	0.3358	1.10	0.76 - 0.82mm	45N
	24	7/0.20	0.2199	0.95		29N
M80-254/257/284/29700XX	26	7/0.15	0.1237	0.80	0.50 - 0.56mm	18N
	28	7/0.12	0.0792	0.71		9.8N

### Harwin North America

T: +1 603 893 5376  
E: mis@harwin.com W: www.harwin.com

### Harwin Europe

T: +44 (0) 23 9231 4545  
E: mis@harwin.co.uk W: www.harwin.com

### Harwin Asia

T: +65 6 779 4909  
E: mis@harwinasia.com W: www.harwin.com

## **GENERAL INFORMATION**

The Hand crimp tool Z80-255 consists of a Rigidus Hand Crimp Tool with a die-set (Z80-244) designed for Trio-Tek crimp contacts. The tool is supplied with a locator (Z80-259), fitted to the rear of the tool, to ensure correct and consistent location of the crimp contacts within the tool.

The Rigidus Hand Crimp Tool includes the following features:

- ❑ Parallel action stroke for accurate and consistent crimp performance
- ❑ Unique locator design for full visibility of contact and wire insertion
- ❑ Symmetric crimp dies and locator allow assembly to suit right or left hand users
- ❑ Lightweight and compact design for easy access
- ❑ Ergonomic handles shaped for low effort crimping
- ❑ Ratchet control to ensure completion of crimp cycles
- ❑ Die closure adjustment function for tool calibration
- ❑ Lifetime tests exceeding 50,000 cycles

The contact is correctly crimped when the tool is free to open at the fully closed position, i.e., when the ratchet releases. The tool cannot be opened without completing the cycle – if the handles have not opened, squeeze the handles together to complete the cycle.

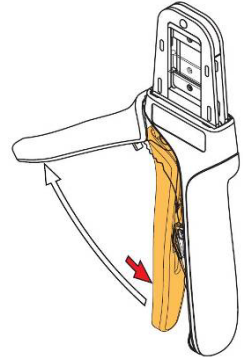

## **TOOL PREPARATION – CHANGING FROM RIGHT TO LEFT HAND OPERATION**

If the locator is fitted, please see section “Troubleshooting – Replacing the Dies” on page 6 for instructions on removing the locator.

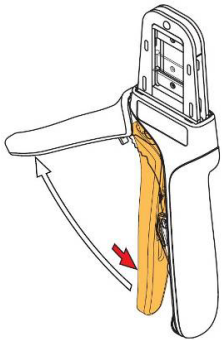

Ensure that the crimp tool is at the fully open position.

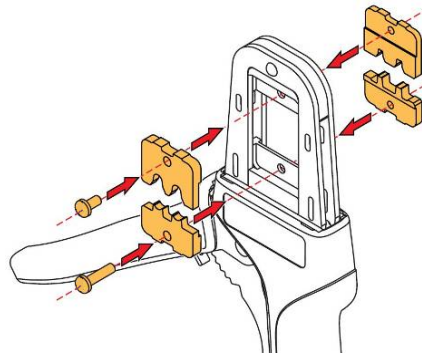

Remove the TX-10 TORX head screws holding the die sets in place.

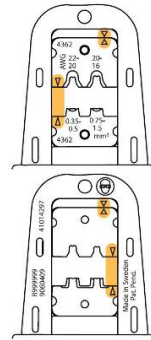

Reverse the die sets, ensuring that the small locating marks line up and are on the outside of the tool.

## **TOOL PREPARATION – ASSEMBLING THE LOCATOR**

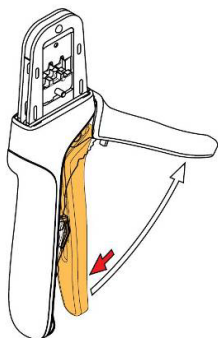

Ensure that the crimp tool is at the fully open position.

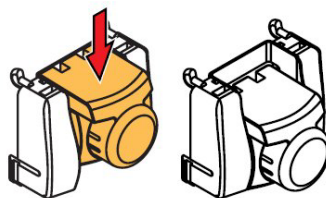

Push down the centre insert of the locator, as far as it will go.

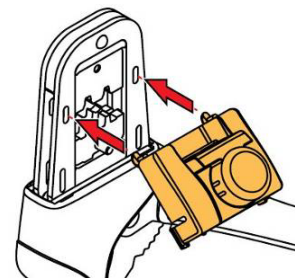

Insert the top hooks of the locator into top slots of the tool frame.

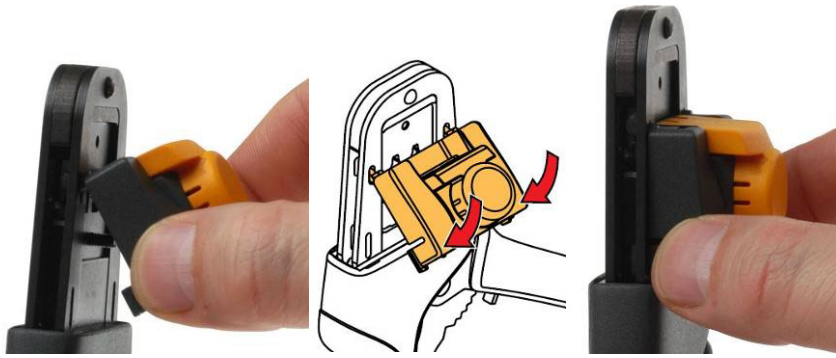

Rotate the locator down, snapping the lower tabs on the locator into the bottom slots on the tool.

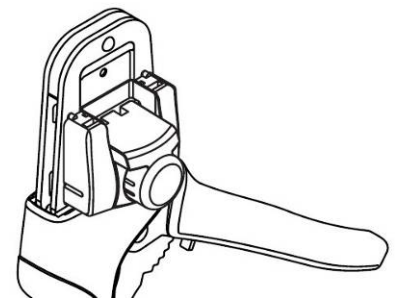

Correct position for the locator.

### **WIRE PREPARATION**

1. Ensure that the wire to be crimped is within the specified range of sizes for the contact and the crimp tool. Failure to use the specified wire size will result in poor quality crimps and possible tool damage.
2. Cut the end of the cable to be terminated so that there is a clean cut end (Figure A). Strip the cable to the correct length (Figure B). We recommend that when the wire is stripped, it is clamped or supported close to the stripping area - this will prevent insulation slippage. Suitable wire strippers (such as a PTFE wire stripper) must be used. This should result in all the strands laying together neatly. If the lay of the strands is disturbed, it may be re-imposed with a slight twist.

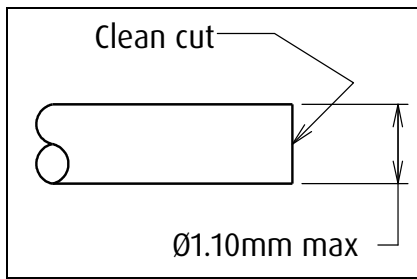

Figure A

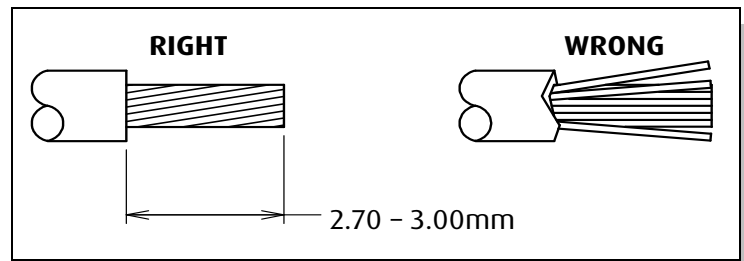
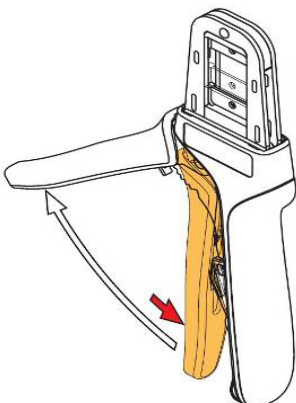

Figure B

### **CRIMPING PROCEDURE**

1. Ensure that the crimp tool is at the fully open position.
2. Push the button on the back of the locator, which will move the locator forward between the crimp dies.



3. Whilst holding the locator in the forward position, insert the crimp contact into the correct locator nest. The wire size is marked on the crimp die, above each location.

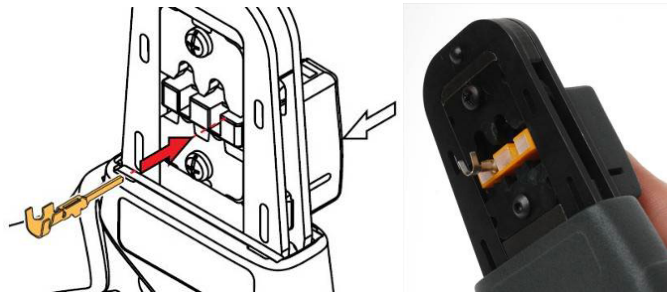

4. Release the locator button, allowing the crimp contact to move back between the crimping jaws.

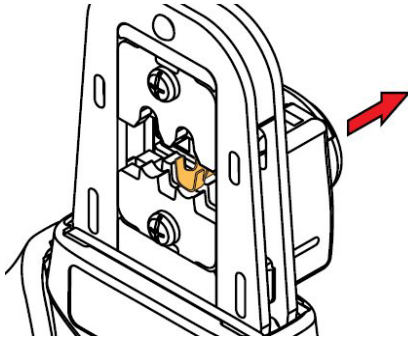

5. Close the handle, until the second ratchet position engages.

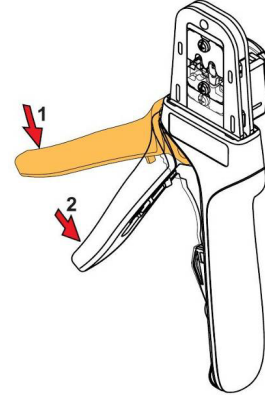

6. Load the stripped wire through the terminal, and against the wire stop inside the tool.

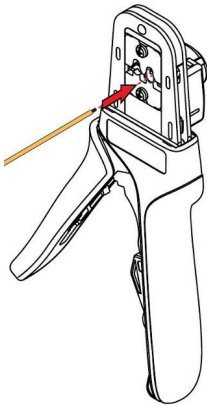

7. Whilst holding the wire against the wire stop, complete the crimp by squeezing the tool handles together through the rest of the ratchet clicks - another 3, to make 5 in total. The handles should then be free to open. Remove the crimped wire.

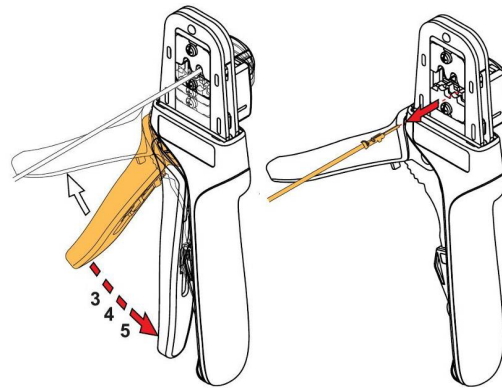

## **CRIMP INSPECTION**

Crimp joints should be checked for:

- ❑ Correctness of form and location of crimp.
- ❑ Freedom of fracture and rough edges.
- ❑ Adequate insertion of all conductor strands in the crimp barrel.
- ❑ Absence of damage to the conductor or the insulation.
- ❑ Correct crimp height, as per crimp height values given on front page.

A destructive pull-off force test should also be performed occasionally, to confirm the hand crimp tool is still operating correctly. The correct values for this test are given on the front page of this instruction sheet. Insulation should be stripped back beyond insulation crimp area before preparing samples for pull-off force test.

## CRIMP INSPECTION (CONT.)

### Crimp Inspection Areas

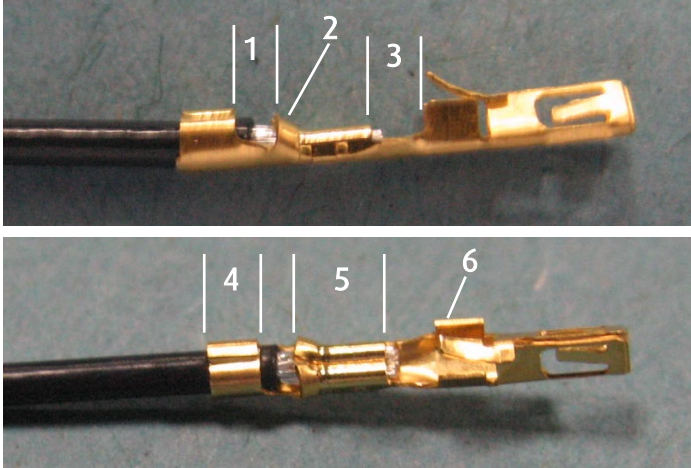

1. Insulation Inspection window
2. Bellmouth
3. Conductor Inspection window
4. Insulation crimp area
5. Conductor crimp area
6. Contact stop ear

### Target



- ❑ Insulation extends past Insulation crimp area, but does not enter Bellmouth.
- ❑ Insulation crimp does not cut or break Insulation.
- ❑ Insulation crimp is fully wrapped around and supporting insulation.
- ❑ Conductors extend past conductor crimp area, but not past contact stop ear.

### Acceptable



- ❑ Insulation in-line with end of crimp area.
- ❑ Conductor in-line with end of crimp area.



- ❑ Insulation butted up to but not entering bellmouth.
- ❑ Conductor in-line with contact stop ear, but not past.

## CRIMP INSPECTION (CONT.)

### Defects



- ❑ Insulation crimp incorrectly formed.



- ❑ Conductor trapped in Insulation crimp.



- ❑ Conductor outside of crimp area.



- ❑ Insulation not visible in Inspection window.

- ❑ Conductor not visible in Inspection window.



- ❑ Insulation enters bellmouth

- ❑ Conductor extends past stop ear

## **ASSEMBLY – CRIMP INTO HOUSING**

The completed crimp can now be inserted into the appropriate Trio-Tek crimp housing. For larger wire sizes, no other tooling should be required for this operation; the crimps can be pushed in by hand. Crimps are assembled into the mould with the retaining tang towards the outer edge of the housing. With thinner wires, it may be helpful to push onto the back of the crimp with the Extraction Tool Z80-258.

If it is necessary to remove a crimp once assembled, please see Instruction Sheet IS-28 for details on the Extraction Tool Z80-258.

## **TROUBLESHOOTING – MISCRIMPS OR JAMS**

Should the tool become stuck or jammed in a partially closed position, **Do Not force the handles open or closed**. There is a ratchet release lever located inside the movable handle. Pressing up on this lever will release the ratchet, and the handles should then easily open. The jam or miscrimp can then be removed.

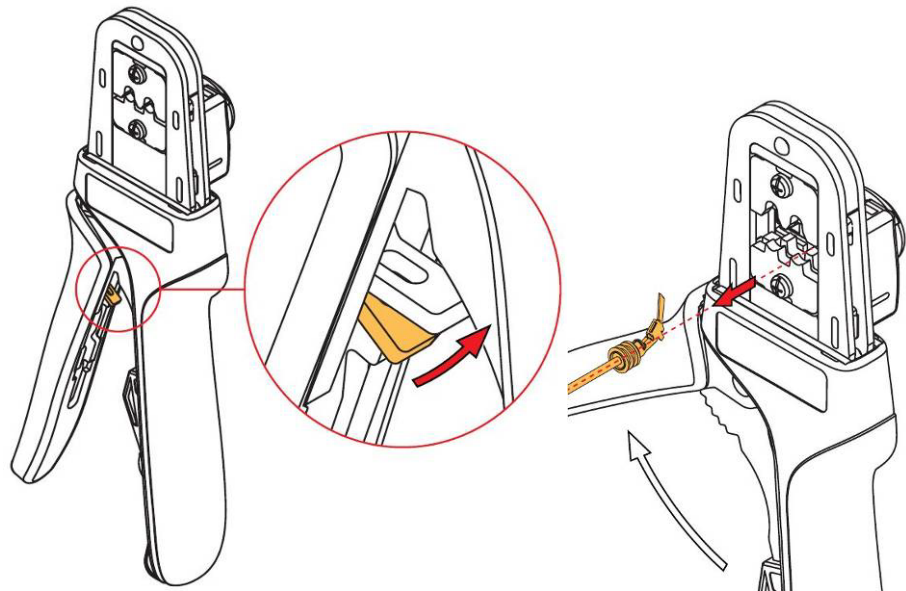

## **TROUBLESHOOTING – LOW PULL-OFF FORCE**

This tool is supplied as new, set to the right preload force necessary to crimp the Trio-Tek contacts. However, over time, this force may fall off slightly. The tool can be adjusted to cater for this wear, and raise the preload force to give correct crimps.

If you need to carry out this procedure, Harwin recommend that you crimp a number of samples before and during adjustment, until the pull-off force achieved exceeds the minimum values shown on the first page of this instruction sheet.

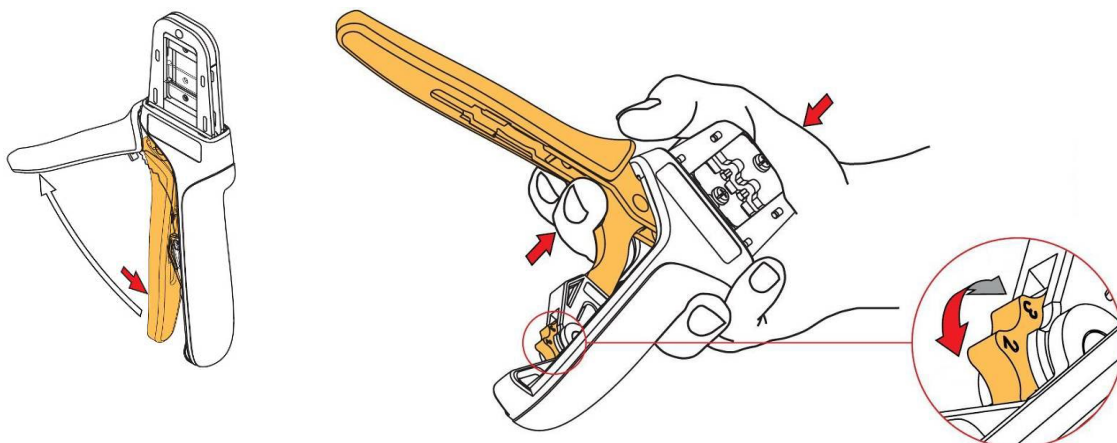

Ensure that the crimp tool is at the fully open position

Hold the hand tool as shown in the above figure, and squeeze the link bar in towards the top of the tool. This releases the preload adjustment wheel.

Rotate the setting wheel to a different setting – the higher the number displayed, the higher the preload force.

Release the link to lock the wheel in place.

If the wheel has been set to the maximum setting possible, then the tool is no longer capable of achieving the minimum pull-off force and should be replaced.

## **TROUBLESHOOTING – REPLACING THE DIES**

If you need to remove the dies to clean the tool, or replace the dies due to damage, then this section will tell you how to remove the locator and the dies.

If you need to replace the die-set, spare die-sets are available from Harwin. Please request Part Number Z80-244.

### **Removing the Locator:**

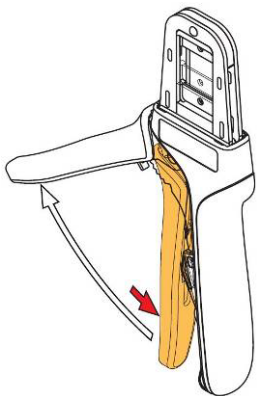

1. Ensure that the crimp tool is at the fully open position.

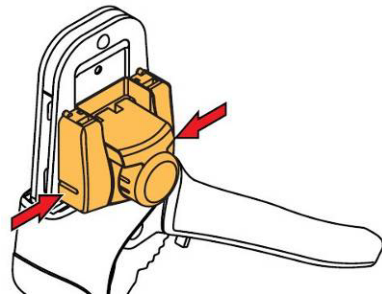

2. Squeeze gently on the lower area of the locator shown in the above picture, with your thumb and index finger.

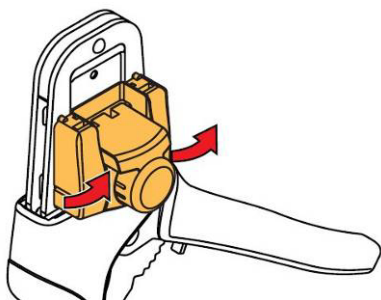

3. Lift the bottom of the locator and swing it away from the tool.

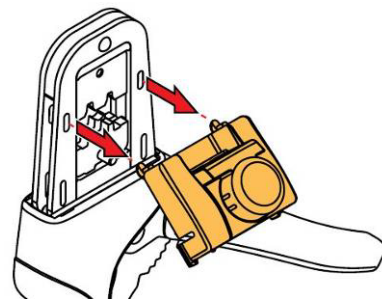

4. The upper hooks should slip out of the top slots easily.

### **Removing and Replacing the Die Set:**

Please see the instructions detailed within the section “Tool Preparation – Changing from Right to Left Hand Operation”, on page 2.

### **Replacing the Locator:**

Please see the instructions detailed within the section “Tool Preparation – Assembling the Locator”, on page 2.



## **CARE OF TOOL**

Although the Rigidus tool is engineered for durability, it is recommended that the following maintenance points are observed, to maximise the life of the tool.

1. Remove dust, moisture, and other contaminants with a clean brush, or soft, lint-free cloth.
2. Do not use any abrasive materials that could damage the tool.
3. All pins, pivot points and bearing surfaces should be covered with a thin coat of high quality machine oil – do not oil excessively. Light oil (such as 30 weight automotive oil) used at the oil points shown in the diagram, is recommended.

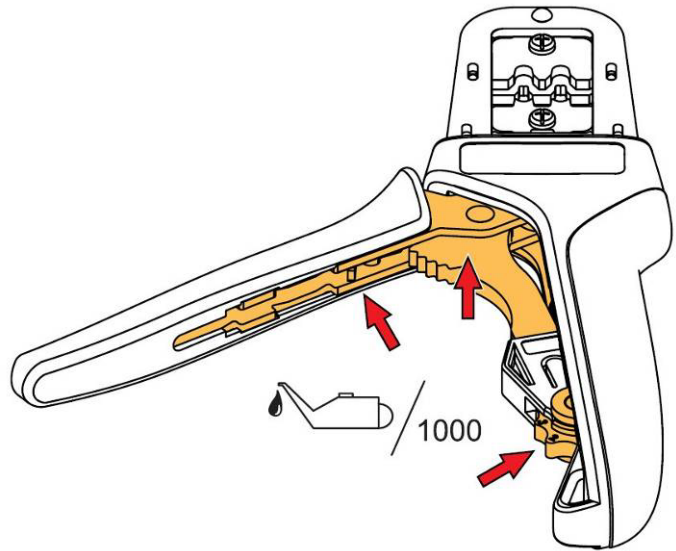

4. Wipe excess oil from hand tool, particularly from the crimping area. Oil transferred onto crimp contacts may affect the electrical characteristics of the connector.
5. When tool is not in use, keep the handles closed to prevent objects from becoming lodged in the crimping dies, and store the tool in a clean, dry area.

## **ADVICE ON USE**



Wear eye protection at all times.



Manual tools such as this Rigidus tools are intended for low volume use. Repetitive, high-volume use is not recommended.



The insulated rubber handles are not designed or certified for protection against electrical shock.

Use with the Trio-Tek crimp contacts listed on the first page of this instruction sheet.

This tool is designed for hand use only, and must not be used with clamping, fixturing or use of handle extensions.

If you have any questions about this instruction sheet, or the Trio-Tek range of Datamate connectors, please contact [datamate@harwin.com](mailto:datamate@harwin.com).