

FRONT

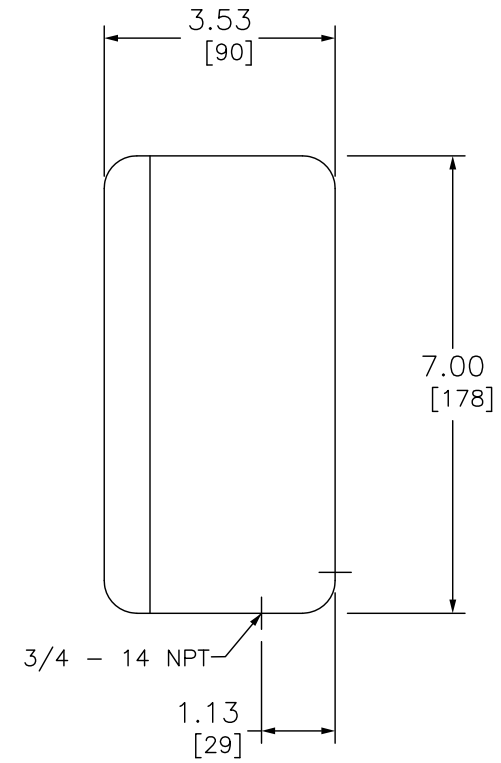

RIGHT

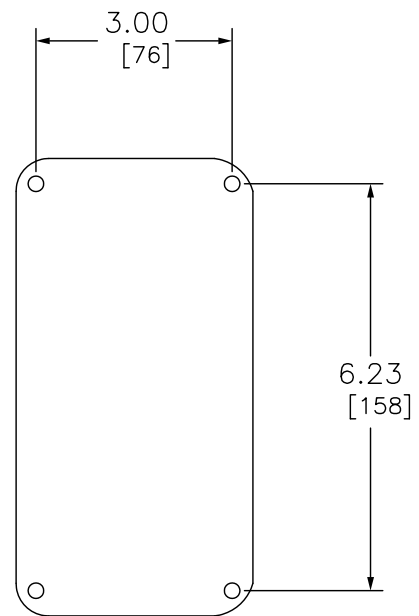

BACK

DUAL DIMENSIONS: INCHES  
MILLIMETERS

CONTROL STATION + OPERATORS



DWG# 9001KYK317  
NO.