

MATERIAL AND FINISH:

Insulator: Polycarbonate, UL-94V-0 rated
Contacts: Brass

ELECTRICAL SPECIFICATIONS:

Current rating: 10 A/15 A
Voltage rating: 250 VAC
Insulation resistance: 100 Mohm min. at 500 VDC
Dielectric withstanding voltage: 2000 VAC for one minute

ORDERING CODE:

43R03-3 - - -
1 2 3 4

1) COLOR

- 1 = BLACK
- 2 = GRAY



2) TERMINAL OPTIONS

- 1 = .187(4.8) WITH Ø1.4
- 2 = .250(6.3) WITH Ø1.65

3) ELECTRICAL CIRCUIT CONFIGURATION

1 = 10A 250V 70°C 

15A 250V 70°C 
2+GROUND 

2 = 10A 250V 120°C 
15A 250V 120°C 
2+GROUND 

4) PANEL THICKNESS

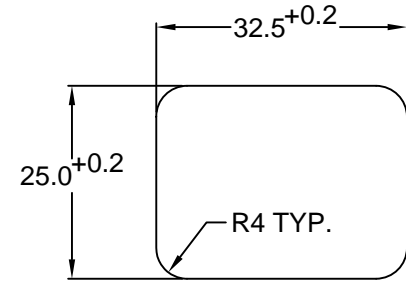
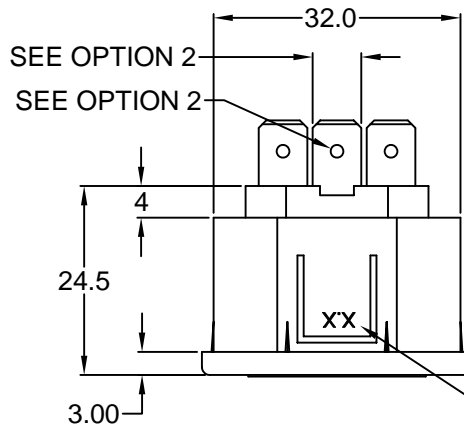

RECOMMENDED PANEL CUTOUT

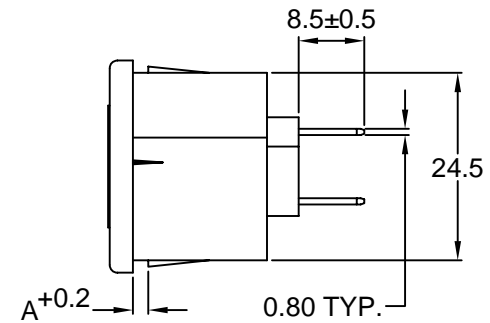
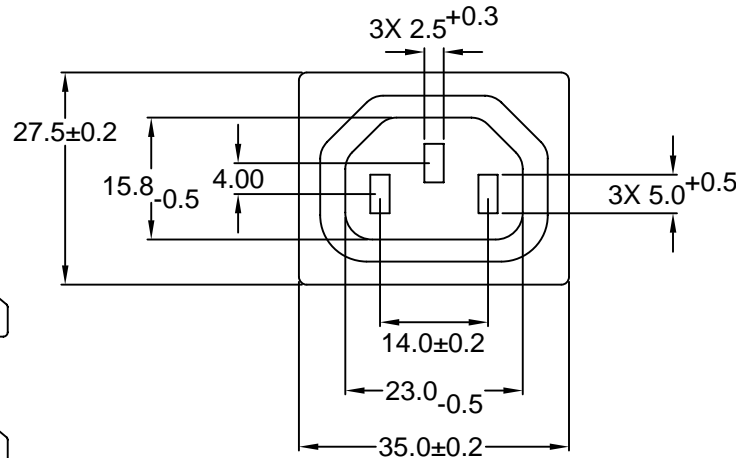

| P/N | A | MAX. PANEL THICKNESS |
|----------------|-----|----------------------|
| 43R03-3XXX-150 | 1.5 | 1.5 |
| 43R03-3XXX-200 | 2.0 | 2.0 |
| 43R03-3XXX-250 | 2.5 | 2.5 |

ADDITIONAL PANEL THICKNESS AVAILABLE ON REQUEST

| | | | | |
|-----|------|---------|-----------------|------|
| REV | DATE | CHANGE | CHK | APPR |
| | A | 10/8/04 | ORDERING CODE # | PB |

| | |
|--------------------------------------|----------|
| TOLERANCE UNLESS OTHERWISE SPECIFIED | |
| X | ± 1 |
| X.X | ± 0.4 |
| X.XX | ± 0.20 |
| DRAWN BY | GQ |
| DATE: | 10/05/01 |
| CHECK BY | TD |
| DATE: | 10/09/01 |
| APPR BY | PB |
| DATE: | 10/09/01 |

RoHS COMPLIANT

Power Dynamics, Inc.

Phone: 973 560-0019 Whippany, New Jersey Fax: 973 560-0076

PART: 10A/15A IEC 60320 APPL. OUTLET; QC
TERMINALS; SNAP-IN, PANEL MOUNT

| | | |
|-----------------------|--|-----------------|
| 43R03-3XXX-XXX | | SHEET 1 of 1 |
| PART #: | | |
| SIZE: A | ALL DIMENSIONS FOR REFERENCE ONLY DIMENSIONS ARE IN MILLIMETERS | REV: A |
| SCALE: NTS | | |