

T497H336K025BH6411

T497 HRA, Tantalum, MnO₂ Tantalum, HRA, 33 uF, 10%, 25 VDC, SMD, MnO₂, Molded, High Reliability, Medical, B (0.1%/1000 Hrs), 900 mOhms, 7238, Height Max = 3.17mm

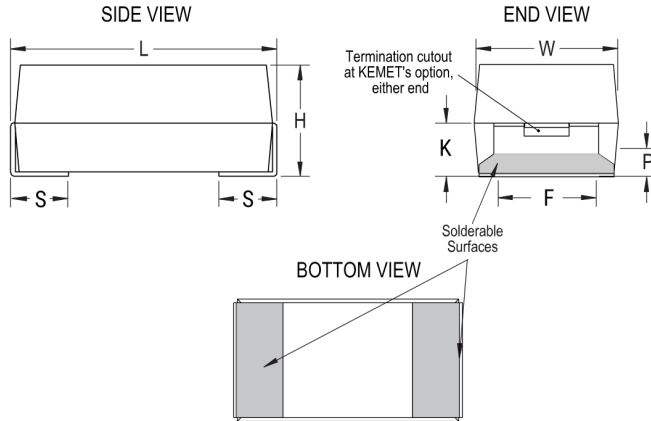

Click [here](#) for the 3D model.

Dimensions

Footprint	7238
L	7.24mm +/-0.38mm
W	3.81mm +/-0.38mm
H	2.79mm +/-0.38mm
S	1.27mm +0.25/-0.13mm
F	3.68mm +0.13/-0.51mm
K	1.52mm MIN
P	0.76mm MIN

Packaging Specifications

Packaging	T&R, 178mm
Packaging Quantity	500

General Information

Series	T497 HRA
Dielectric	MnO ₂ Tantalum
Style	SMD Chip
Description	SMD, MnO ₂ , Molded, High Reliability, Medical
Features	High Reliability, Medical
RoHS	No
Prop 65	⚠ WARNING: Cancer and reproductive harm - http://www.p65warnings.ca.gov .
SCIP Number	1dd2e1b8-26dd-4d52-927c-6f9d519011aa
Termination	Solder Coated
Qualifications	CWR09/19/29 Style
AEC-Q200	No
Component Weight	349.01 mg
Miscellaneous	F1 Technology + Simulated Breakdown Screening (SBDS).
Notes	Note: When solder coated terminations are required, add an additional 0.38mm (0.015inch) to the tolerances for "L", "W", "H", "K", "F" and "S".
MSL	1

Specifications

Capacitance	33 uF
Capacitance Tolerance	10%
Voltage DC	25 VDC (85C), 16.75 VDC (125C)
Temperature Range	-55/+125°C
Rated Temperature	85°C
Humidity	85C, 85% RH, 1000 Hours, No Load
Dissipation Factor	8% 120Hz 25C
Failure Rate	B (0.1%/1000 Hrs)
Resistance	0.9 Ohms (100kHz 25C)
Ripple Current	408 mA (rms, 100kHz 25C)
Leakage Current	8.3 uA (5min 25°C)
Testing and Reliability	10 Cycles Surge Current Testing At -55C And +85C

Statements of suitability for certain applications are based on our knowledge of typical operating conditions for such applications, but are not intended to constitute - and we specifically disclaim - any warranty concerning suitability for a specific customer application or use. This information is intended for use only by customers who have the requisite experience and capability to determine the correct products for their application. Any technical advice inferred from this information or otherwise provided by us with reference to the use of our products is given gratis, and we assume no obligation or liability for the advice given or results obtained.