

THERMO 4 click schematic v100

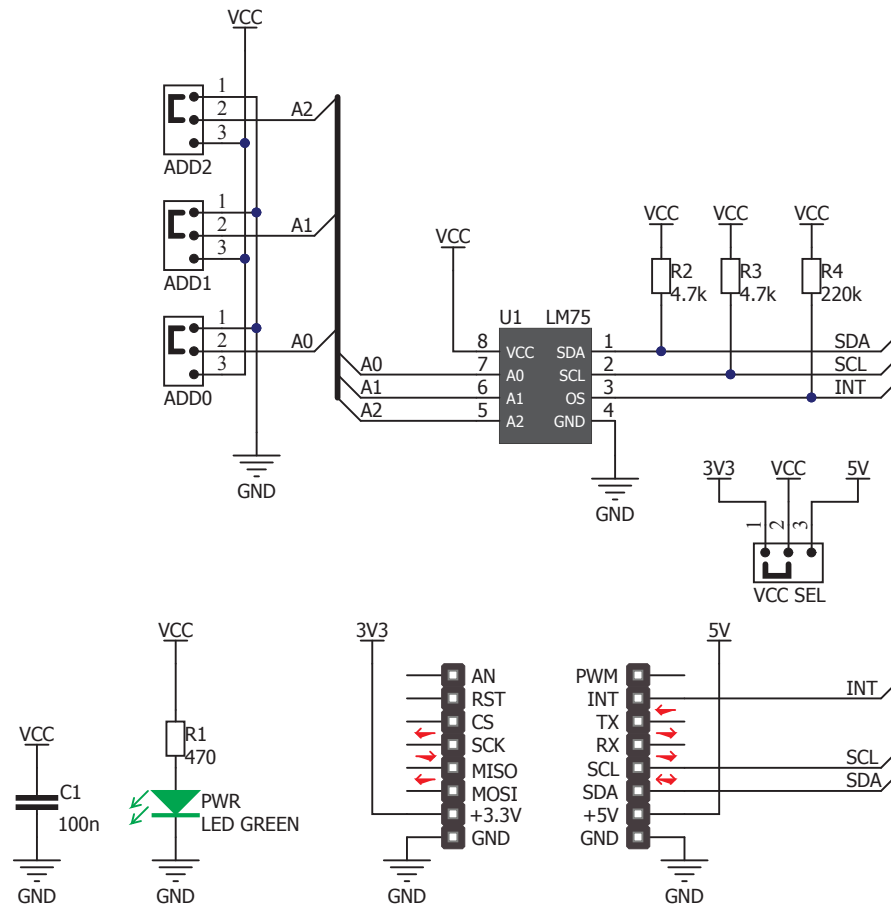

www.mikroe.com