

IEC Appliance Inlet C14 or C18 with Circuit Breaker TA35 2-pole



Screw-on with IP67 and TA35 in white with black printed symbols



Screw-on with IP67



Snap-in IP40 with TA35 red illuminated and embossed symbols



See below:
[Approvals and Compliances](#)

Description

- Panel mount :
Screw-on version from front or rear side, snap-in version front side
- 2 Functions :
Appliance Inlet , protection class I or II , Circuit breaker type TA35 , 2-pole
- Pre-wired coupling
- V-Lock notch standard
- Quick connect terminal 6.3 x 0.8 mm

Unique Selling Proposition

- Variant tested for IP67 into the appliance
- Various mounting options
- Recessed rocker prevents accidental manipulation
- Compatible with V-Lock cord retention

Characteristics

- Connector and circuit breaker are prewired
- Circuit Breaker non-illuminated or illuminated
- Suitable for use in equipment according to IEC/UL 62368-1

Other versions on request

- Version without pre-wiring from inlet to circuit breaker
- Protection class II, 70°C
- Variants in white

References

Substitute for type [6135](#)
 Component: circuit breakers [TA35 Rocker 2Pole](#); [TA36 Rocker](#)
 Alternative: version with line filter [DG12](#)

Weblinks

[pdf data sheet](#), [html datasheet](#), [General Product Information](#), [Approvals](#), [Distributor-Stock-Check](#), [Accessories](#), [Detailed request for product](#)

Technical Data

Ratings IEC	10A / 250VAC; 50Hz
Ratings UL/CSA	15A / 250VAC; 60Hz
Dielectric Strength	> 2.5kVAC between L-N > 3kVAC between L/N-PE (1 min/50Hz)
Allowable Operation Temperature	-25°C to 60°C
IP-Protection	front side IP40 / IP67 acc. to IEC 60529
Protection against electric shock	Suitable for appliances with protection class I or II acc. to IEC 61140
Terminal	Quick connect terminals 6.3 x 0.8 mm
Panel Thickness S	Screw: max 8 mm Recommended torque min 0.25Nm Snap-in : S =1/1.2/1.5/2/2.5/3 mm
Material: Housing	Thermoplastic, black, UL 94V-0

Appliance inlet/-outlet	C14 / C18 acc. to IEC 60320-1 UL 60320-1, CSA C22.2 no. 60320-1 (for cold conditions) pin-temperature 70 °C, 10A, Protection Class I or II
Circuit Breakers	Acc. IEC/EN 60934, UL 1077, CSA 22.2 no. 235 2-pole rocker switch, illuminated or non-illuminated. Conditional short circuit Inc: 2000 A

Approvals and Compliances



Detailed information on product approvals, code requirements, usage instructions and detailed test conditions can be looked up in [Details about Approvals](#)

SCHURTER products are designed for use in industrial environments. They have approvals from independent testing bodies according to national and international standards. Products with specific characteristics and requirements such as required in the automotive sector according to IATF 16949, medical technology according to ISO 13485 or in the aerospace industry can be offered exclusively with customer-specific, individual agreements by SCHURTER.

Approvals



The approval mark is used by the testing authorities to certify compliance with the safety requirements placed on electronic products.

Approval Reference Type: DG11

Approval Logo	Certificates	Certification Body	Description
	VDE Approvals	VDE	Certificate Number: 40048151
	UL Approvals	UL	UR File Number: E96454
	CCC Approvals	CCC	CCC Certificate Number: 2019180204007932, 2019180204007907

Product standards

Product standards that are referenced

Organization	Design	Standard	Description
	Designed according to	IEC 60320-1	Appliance couplers for household and similar general purposes
	Designed according to	UL 60320-1	Standard for Attachment Plugs and Receptacles
	Designed according to	CSA C22.2 no. 60320-1	General Use Receptacles, Attachment Plugs, and Similar Wiring Devices







Application standards

Application standards where the product can be used

Organization	Design	Standard	Description
	Designed for applications acc.	IEC/UL 62368-1	Audio/video, information and communication technology equipment - Part 1: Safety requirements

Compliances

The product complies with following Guide Lines

Identification	Details	Initiator	Description
	CE declaration of conformity	SCHURTER AG	The CE marking declares that the product complies with the applicable requirements laid down in the harmonisation of Community legislation on its affixing in accordance with EU Regulation 765/2008.
	UKCA declaration of conformity	SCHURTER AG	The UKCA marking declares that the product complies with the applicable requirements laid down in the British Amendment of Regulation (EC) 765/2008.
	RoHS	SCHURTER AG	Directive RoHS 2011/65/EU, Amendment (EU) 2015/863
	China RoHS	SCHURTER AG	The law SJ / T 11363-2006 (China RoHS) has been in force since 1 March 2007. It is similar to the EU directive RoHS.
	REACH	SCHURTER AG	On 1 June 2007, Regulation (EC) No 1907/2006 on the Registration, Evaluation, Authorization and Restriction of Chemicals 1 (abbreviated as "REACH") entered into force.
		SCHURTER AG	V-Lock system are based on a matching plug-dose combination. The connector is equipped with a notch intended for use with the latching cordset. The cord latching system prevents against accidental removal of the cordset.

Dimensions [mm]

Snap-in mounting for front mount IP40

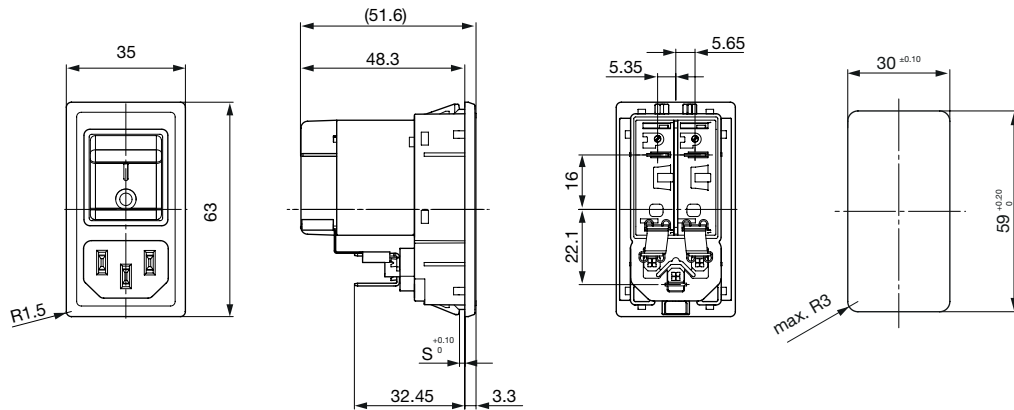

S = Panel thickness

Screw-on mounting version A for front mount IP40

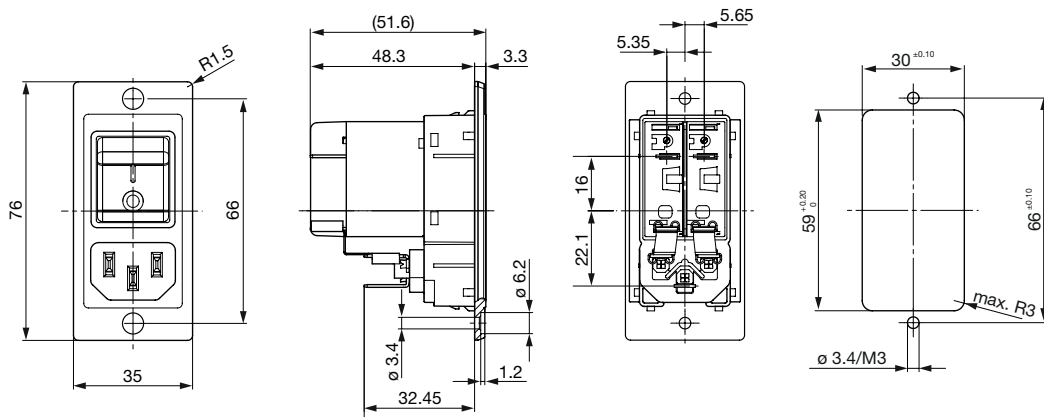

Screw-on mounting Version A for rear mount IP40

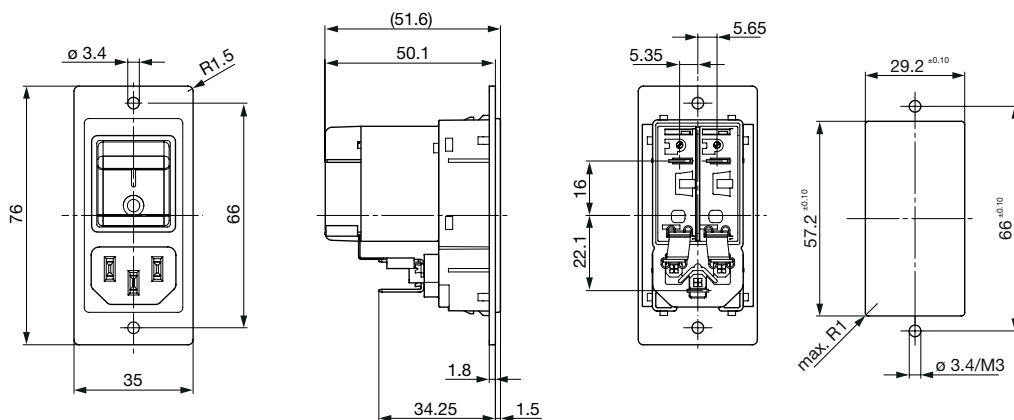

Screw-on mounting Version B for front mount IP40

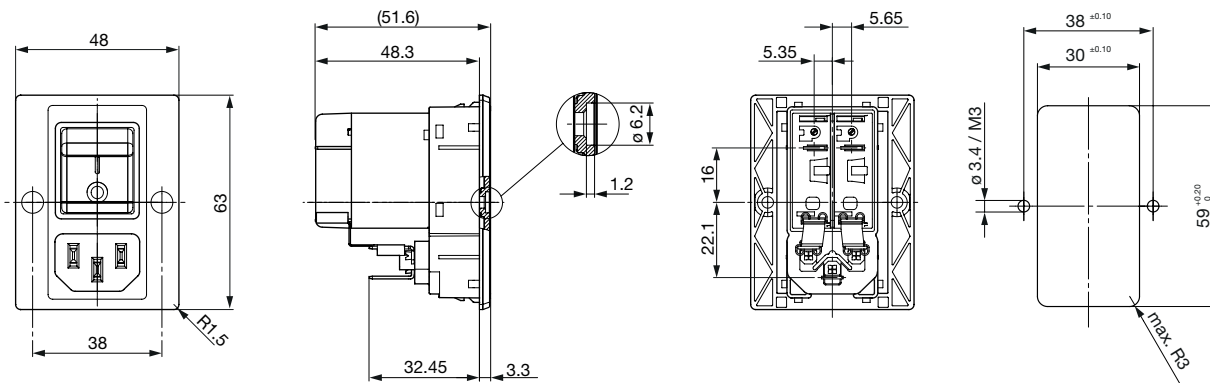

Screw-on mounting version B for rear mount IP40

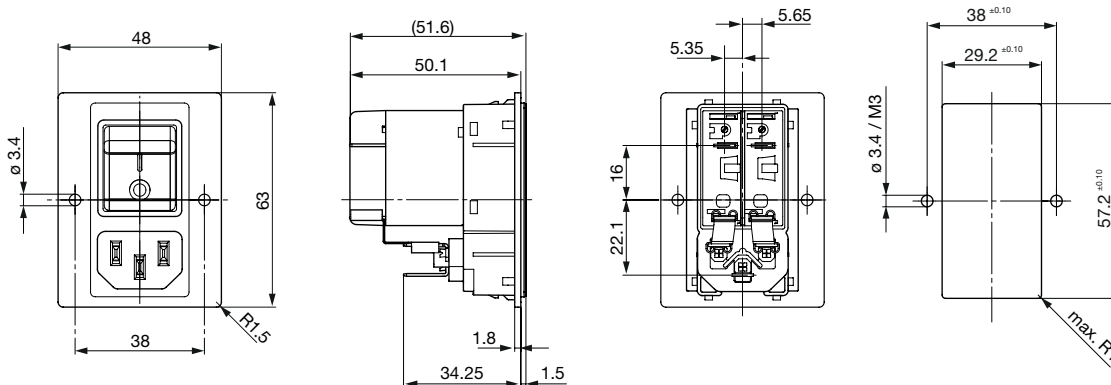

Screw-on mounting for front mount IP67

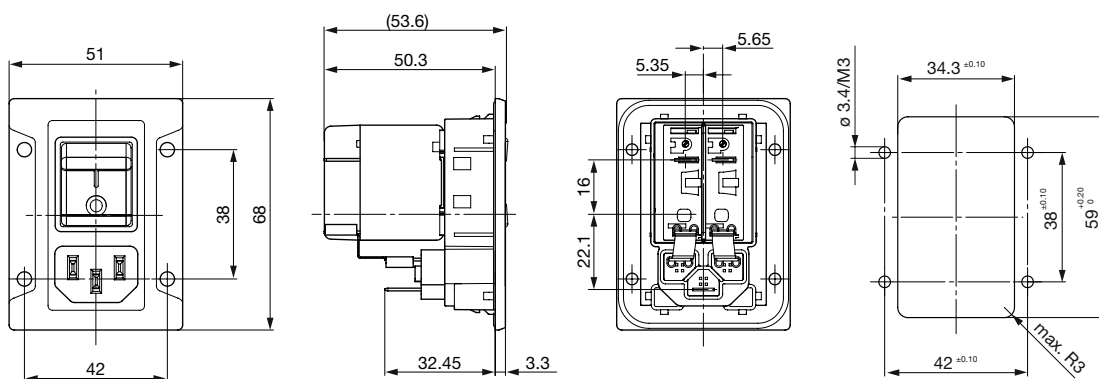

Diagrams

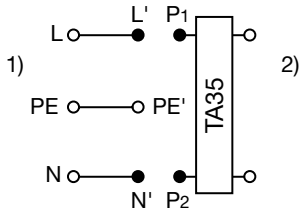

- 1) Line
- 2) Load

Effect of ambient temperature

The units are calibrated for an ambient temperature of +23°C. To determine the rated current for a lower or higher ambient temperature, use a correction factor (typical value) from the table below:

Ambient Temperature [°C]	Correction factor
-30	0.76
-20	0.81
0	0.90
+23	1.00
+40	1.03
+50	1.04
+60	1.06

Example: Rated current = 5 A, Environmental temperature = 50 °C --> Correction factor = 1.04, Resulting current = 5.2 A --> Fount to next higher rated current: 6 A

Time-Current-Curves

Tripping Characteristics $I_n < 3 A$

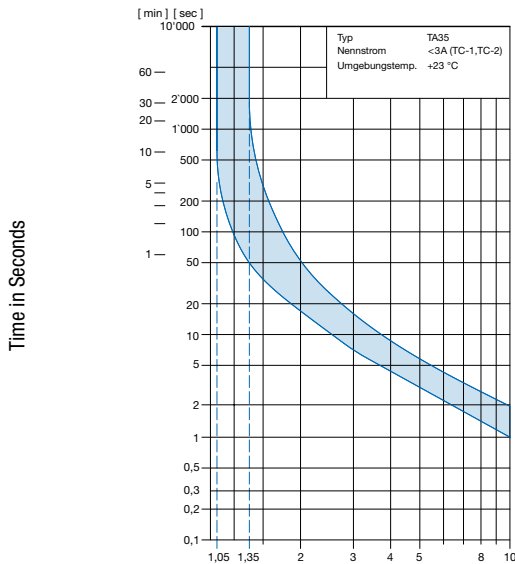

Multiple of Rated Current In

Ambient temperature +23°

Tripping Characteristics $I_n \geq 3 \dots \leq 15 A$

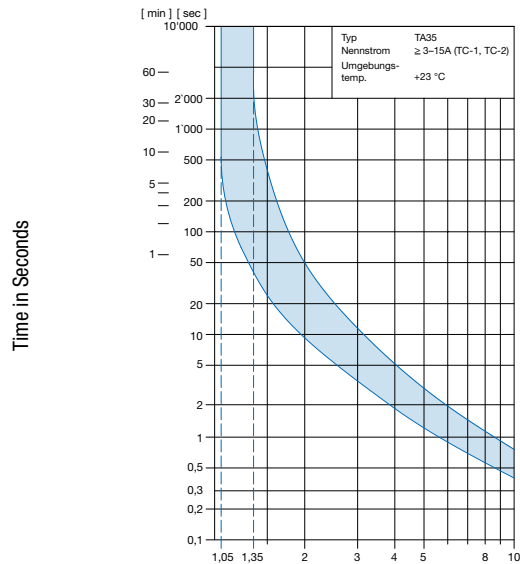

Multiple of Rated Current In

Ambient temperature +23°

Configuration Code

Typ	Configuration Code (Example) TA35				
DG11	C B D W F 1 2 0 C 0	-000-	C6135-	XXX -	XXX -00
	see table 1				

Color	0	Black
Panel Mounting	00	Screw version A front mounting
	01	Screw version B front mounting
	02	Screw version A rear mounting
	03	Screw version B rear mounting
	10	Snap-in 1.0 mm
	12	Snap-in 1.2 mm
	15	Snap-in 1.5 mm
	20	Snap-in 2.0 mm
	25	Snap-in 2.5 mm
	30	Snap-in 3.0 mm
	88	Screw version front mounting (sealed towards housing, IP67)
Terminal PE	0	Without (PCII)
	1	QC 6.3x0.8 mm
Terminal N	1	QC 6.3x0.8 mm (unwired)
	3	Connection to TA35 (wired)
Terminal L	1	QC 6.3x0.8 mm (unwired)
	3	Connection to TA35 (wired)

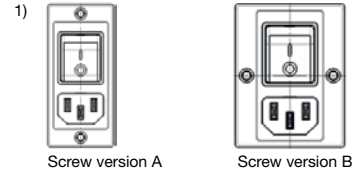

ORDER CODE

Table 1 Selection for type TA35

Order example

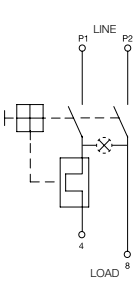
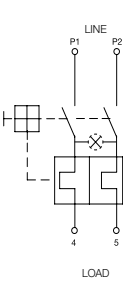
Number of switched poles Number of protected poles		2-pole	
		1	2
			
Switch	without illumination	CBT	CBD
Switch	illuminated 240 V 120 V	C12 C14	C32 C34

Other versions on request

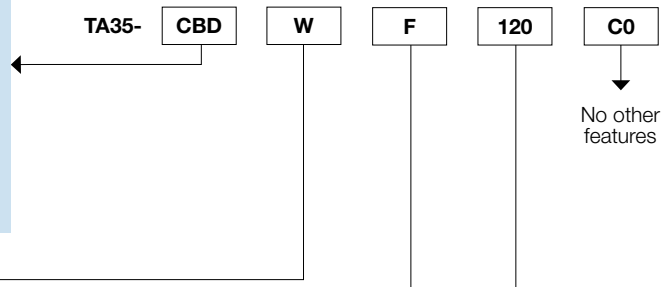

Colours

	Switch front	Rocker	
		non-illuminated	illuminated
W	black	white	–
B	black	black	–
3	black	–	red transparent
4	black	–	green transparent
6	black	–	orange transparent

Other colours on request

Rocker legend

	Surface	Illustration		Colour of print
F	embossed	–	o	
H	printed	ON	OFF	white
K	printed	ON	OFF	black
L	printed	–	o	white
M	printed	–	o	black

Other legends on request

Position of the rocker legend e.g. I / O

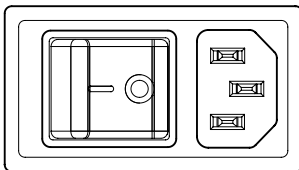

Rated current I_n (A)

I _n	Code	I _n	Code
1,0	J10	8,0	080
2,0	J20	10,0	100
4,0	040	12,0	120*
5,0	050	15,0	150*
6,0	060		

Other rated currents on request *) UL / CSA only

Variants

Rated Current [A]	Circuit Breaker		Protection Class	Connector			Order Number
	Rocker colour	Illumination		Color	Mounting	IP-Protection	
10	orange transparent	illuminated	I	black	Snap-in mounting	IP40	3-107-924
10	white	non-illuminated	I	black	Screw-on version	IP67	3-108-454
10	black	non-illuminated	I	black	Screw version B	IP40	3-108-463
10	white	non-illuminated	I	black	Snap-in mounting	IP40	3-109-713
10	white	non-illuminated	I	black	Screw version B	IP40	3-109-714
10	white	non-illuminated	I	black	Screw version A	IP40	3-109-715
15	white	non-illuminated	I	black	Snap-in mounting	IP40	3-109-716
15	white	non-illuminated	I	black	Screw version B	IP40	3-109-717
15	white	non-illuminated	I	black	Screw version A	IP40	3-109-718
15	white	non-illuminated	I	black	Screw-on version	IP67	3-109-719

Most Popular.

Availability for all products can be searched real-time: <https://www.schurter.com/en/Stock-Check/Stock-Check-SCHURTER>

More information in the HTML data sheet on the variant table

Packaging unit	10 Pcs
-----------------------	--------

Accessories

Description



RC320
Rear Cover for Power Entry Module

Mating Outlets/Connectors shuttered

Category / Description



[Connector Overview complete](#)

4783 Mounting: Power Cord, 3 x 1 mm² / 3 x 18 AWG, Cable, Connector: IEC C13

4783