

PHE820MB5100MR17

Aliases (F720BD103M275A)

Not for New Design • Recommended Replacement Series R46 X2 310 VAC

PHE820M/F720, Film, Metallized Polyester, Safety, 0.01 uF, 20%, 275 VAC (X2), 760 VDC, 100°C, Lead Spacing = 15mm

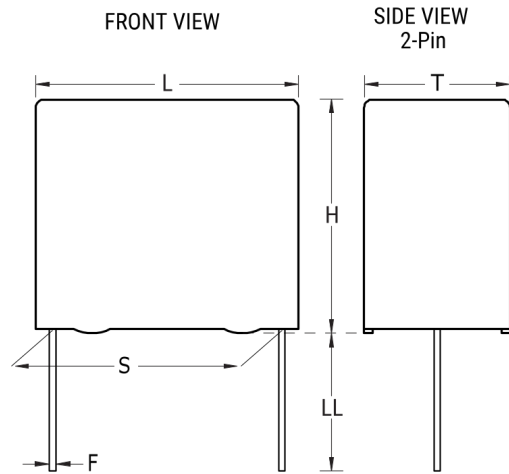

Click [here](#) for the 3D model.

Dimensions

L	18mm MAX
H	10.5mm MAX
T	5.5mm MAX
S	15mm +/-0.4mm
LL	17mm -1mm
F	0.8mm NOM
G	0.5mm NOM

Packaging Specifications

Packaging	Bulk, Bag
Packaging Quantity	800

General Information

Series	PHE820M/F720
Dielectric	Metallized Polyester
Style	Radial
Features	EMI Safety
RoHS	Yes
Lead	Wire Leads
Safety Class	X2
Qualifications	ENEC, UL, cUL
AEC-Q200	No
THB Performance	No
Component Weight	1.615 g
Miscellaneous	SRF= 13 MHz.
Notes	Not for new design – the replacement series is: R46 X2 310VAC.

Specifications

Capacitance	0.01 uF
Capacitance Tolerance	20%
Voltage AC	275 VAC (X2)
Voltage DC	760 VDC
Temperature Range	-40/+100°C
Rated Temperature	100°C
Dissipation Factor	1% 1kHz
Insulation Resistance	30 GOhms
Max dV/dt	100 V/us