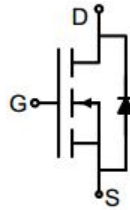
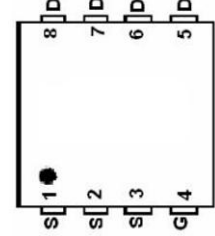
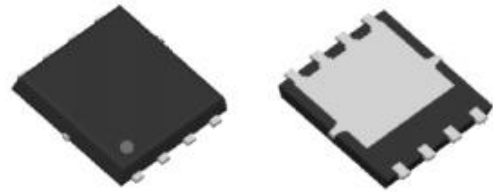

N-Channel Enhancement Mode Power MOSFET

<p>Description</p> <p>The G100N03D5 uses advanced trench technology to provide excellent $R_{DS(ON)}$, low gate charge. It can be used in a wide variety of applications.</p> <p>General Features</p> <ul style="list-style-type: none"> • V_{DS} 30V • I_D (at $V_{GS} = 10V$) 100A • $R_{DS(ON)}$ (at $V_{GS} = 10V$) < 3.5mΩ • $R_{DS(ON)}$ (at $V_{GS} = 4.5V$) < 4.5mΩ • 100% Avalanche Tested • RoHS Compliant <p>Application</p> <ul style="list-style-type: none"> • Power switch • DC/DC converters 		 <p>Schematic Diagram</p>  <p>Marking and pin assignment</p>  <p>DFN5X6-8L</p>	
Device	Package	Marking	Packaging
G100N03D5	DFN5*6-8L	G100N03	5000pcs/Reel

Absolute Maximum Ratings $T_C = 25^\circ\text{C}$, unless otherwise noted

Parameter	Symbol	Value	Unit
Drain-Source Voltage	V_{DS}	30	V
Continuous Drain Current	I_D	100	A
Pulsed Drain Current (note1)	I_{DM}	285	A
Gate-Source Voltage	V_{GS}	± 20	V
Single Pulse Avalanche Energy (note2)	EAS	250	mJ
Power Dissipation	P_D	50	W
Operating Junction and Storage Temperature Range	T_J, T_{stg}	-55 To 150	$^\circ\text{C}$

Thermal Resistance

Parameter	Symbol	Value	Unit
Thermal Resistance, Junction-to-Case	R_{thJA}	50	$^\circ\text{C/W}$
Maximum Junction-to-Case	R_{thJC}	2.5	$^\circ\text{C/W}$

Specifications $T_J = 25^\circ\text{C}$, unless otherwise noted						
Parameter	Symbol	Test Conditions	Value			Unit
			Min.	Typ.	Max.	
Static Parameters						
Drain-Source Breakdown Voltage	$V_{(BR)DSS}$	$V_{GS} = 0V, I_D = 250\mu A$	30	--	--	V
Zero Gate Voltage Drain Current	I_{DSS}	$V_{DS} = 30V, V_{GS} = 0V$	--	--	1	μA
Gate-Source Leakage	I_{GSS}	$V_{GS} = \pm 20V$	--	--	± 100	nA
Gate-Source Threshold Voltage	$V_{GS(th)}$	$V_{DS} = V_{GS}, I_D = 250\mu A$	1.2	1.7	2.5	V
Drain-Source On-Resistance	$R_{DS(on)}$	$V_{GS} = 10V, I_D = 20A$	--	2.5	3.5	m Ω
		$V_{GS} = 4.5V, I_D = 10A$	--	3.5	4.5	
Forward Transconductance	g_{FS}	$V_{DS} = 5V, I_D = 20A$	--	64	--	S
Dynamic Parameters						
Input Capacitance	C_{iss}	$V_{GS} = 0V,$ $V_{DS} = 50V,$ $f = 1.0MHz$	--	5595	--	pF
Output Capacitance	C_{oss}		--	765	--	
Reverse Transfer Capacitance	C_{rss}		--	659	--	
Total Gate Charge	Q_g	$V_{DD} = 15V,$ $I_D = 20A,$ $V_{GS} = 10V$	--	38	--	nC
Gate-Source Charge	Q_{gs}		--	9	--	
Gate-Drain Charge	Q_{gd}		--	13	--	
Turn-on Delay Time	$t_{d(on)}$	$V_{DD} = 15V,$ $I_D = 50A,$ $R_G = 2.5\Omega$	--	26	--	ns
Turn-on Rise Time	t_r		--	24	--	
Turn-off Delay Time	$t_{d(off)}$		--	91	--	
Turn-off Fall Time	t_f		--	39	--	
Drain-Source Body Diode Characteristics						
Continuous Source Current	I_S	$T_C = 25^\circ\text{C}$	--	--	100	A
Body Diode Voltage	V_{SD}	$T_J = 25^\circ\text{C}, I_{SD} = 50A, V_{GS} = 0V$	--	--	1.2	V
Reverse Recovery Charge	Q_{rr}	$I_S = 20A, V_{GS} = 0V$ $di/dt=500A/us$	--	25	--	nC
Reverse Recovery Time	t_{rr}		--	13	--	ns

Notes

1. Repetitive Rating: Pulse width limited by maximum junction temperature
2. $I_{AS} = 20A, V_{DD} = 40V, R_G = 25\Omega, \text{Starting } T_J = 25^\circ\text{C}$
3. Identical low side and high side switch with identical R_G

Typical Characteristics $T_J = 25^\circ\text{C}$, unless otherwise noted

Figure 1. Output Characteristics

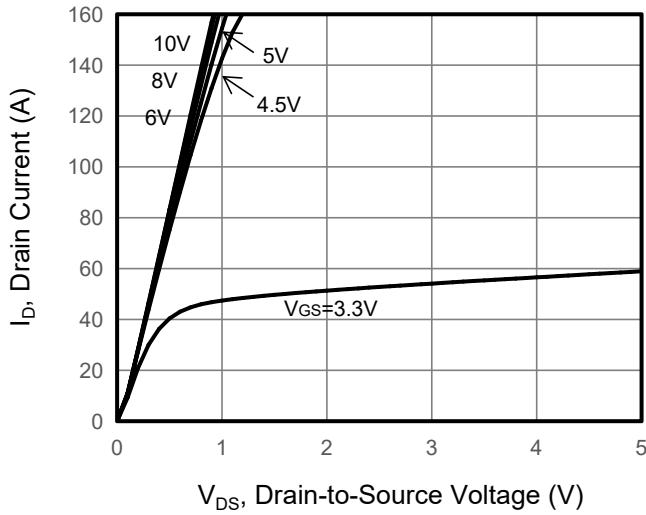

Figure 2. Transfer Characteristics

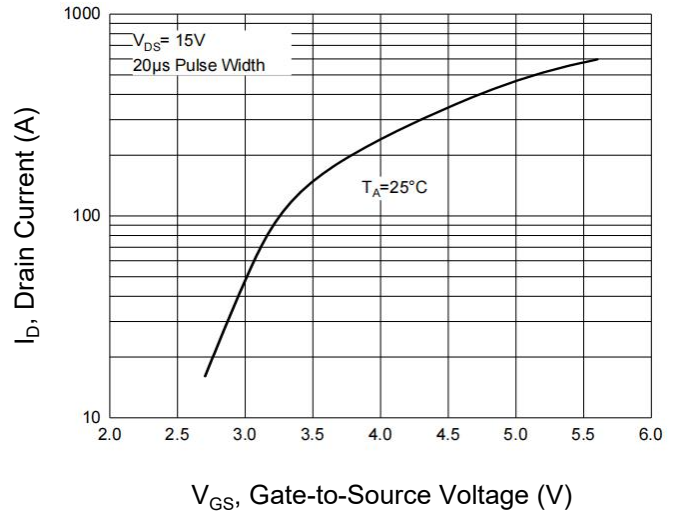

Figure 3. Gate Charge

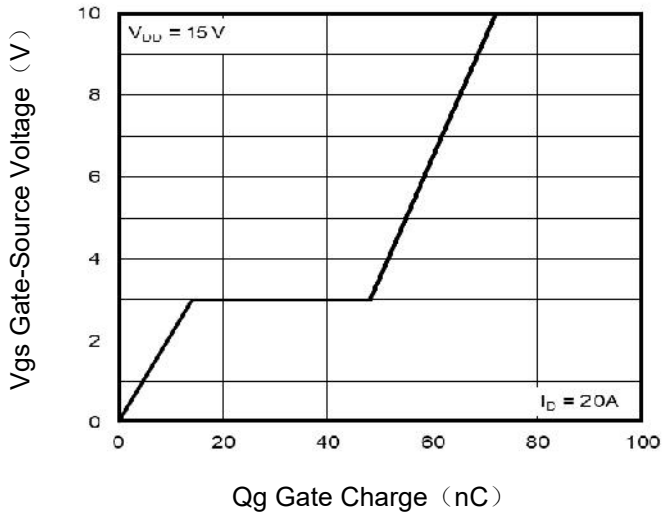

Figure 4. Drain Source On Resistance

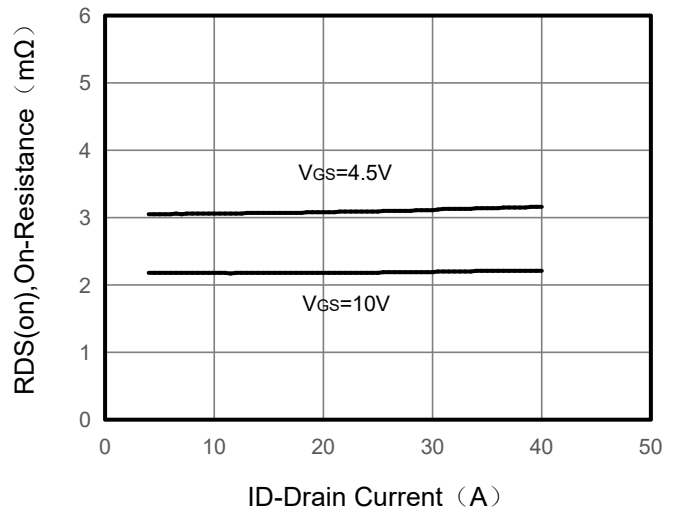

Figure 5. Capacitance vs Vds

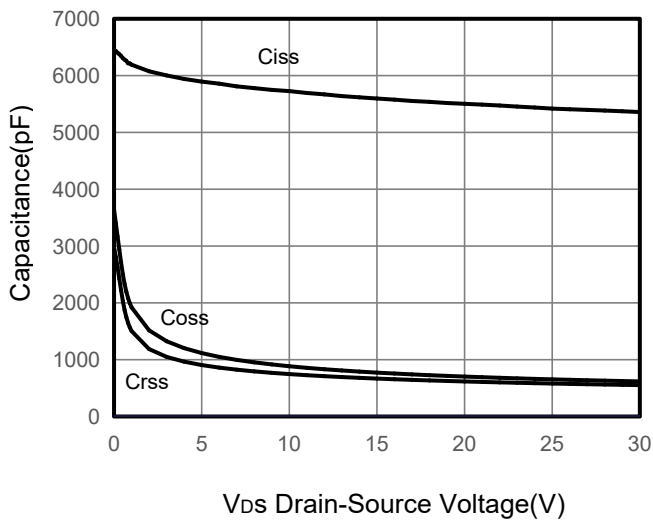
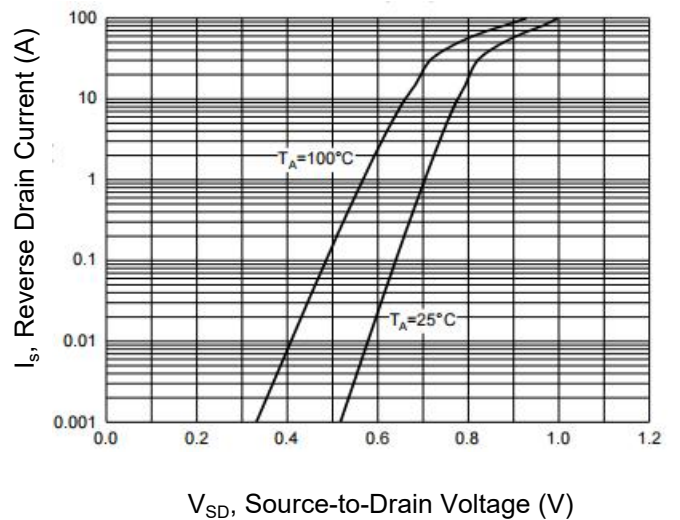

Figure 6. Source-Drain Diode Forward



Typical Characteristics $T_J = 25^\circ\text{C}$, unless otherwise noted

Figure 7. Drain-Source On-Resistance

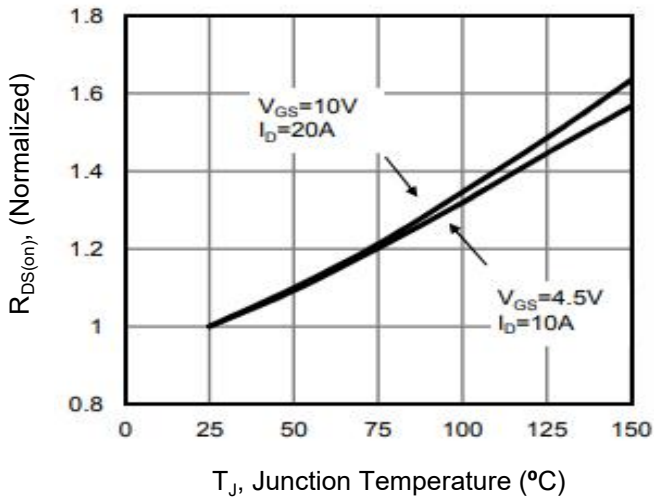

Figure 8. Safe Operation Area

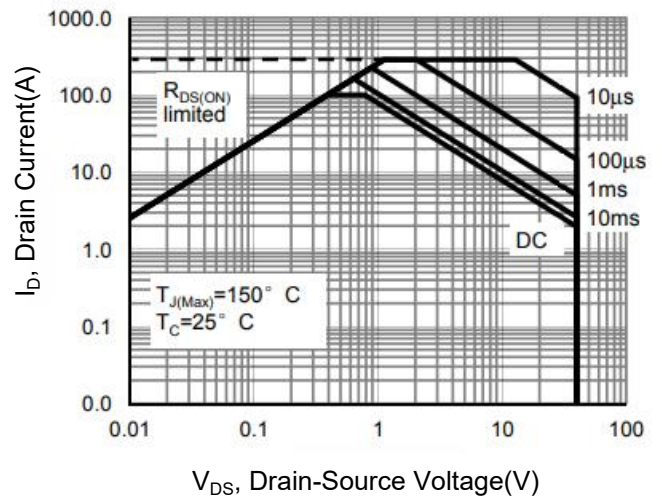
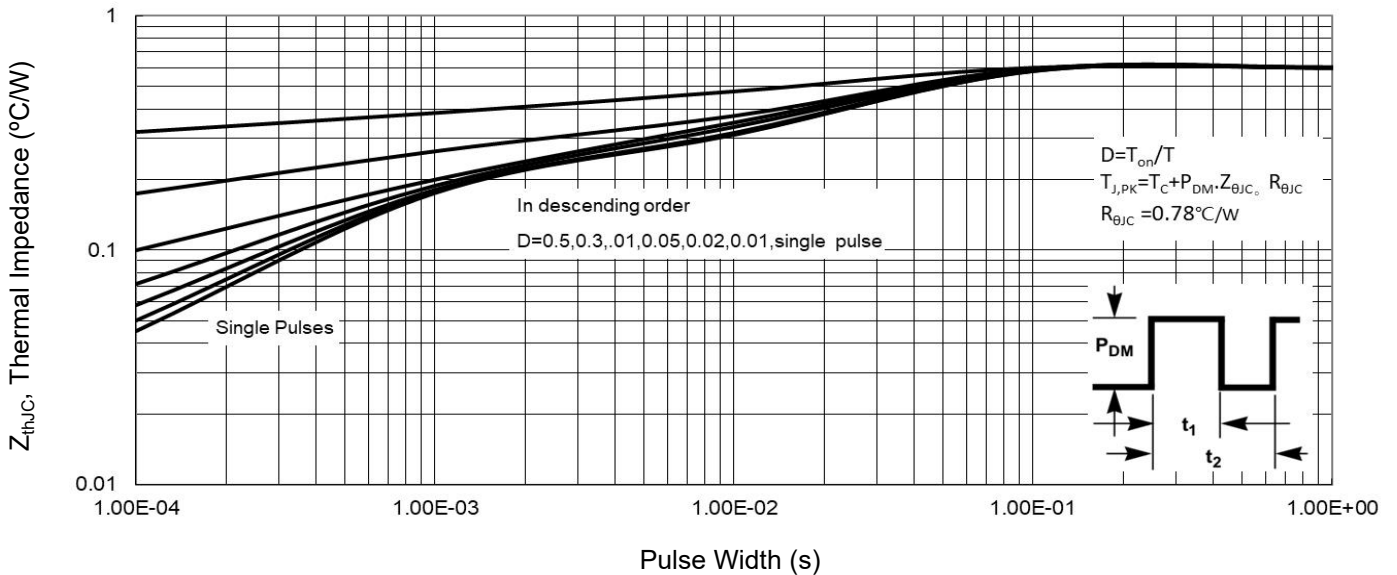
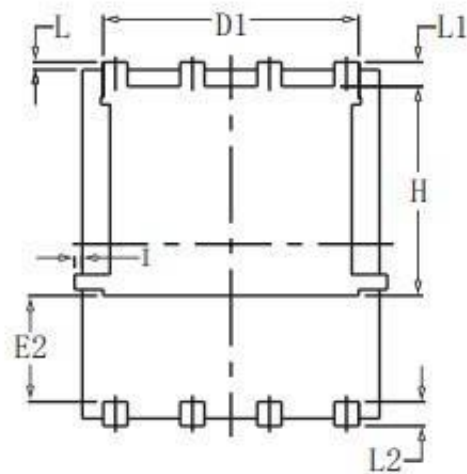
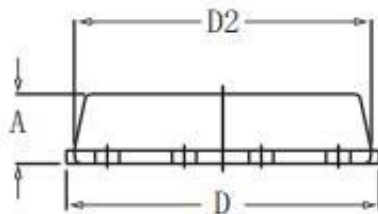
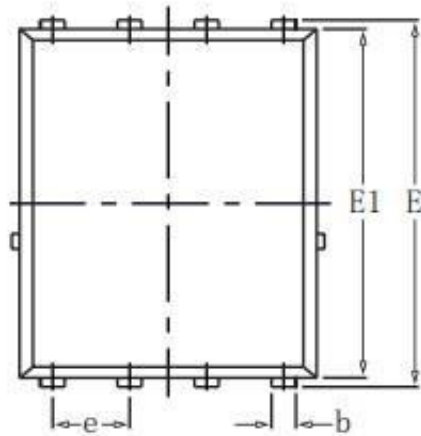

Figure 9. Normalized Maximum Transient Thermal Impedance



DFN5*6-8L Package Information



SYMBOL	COMMON			
	MM		INCH	
	MIN	MAX	MIN	MAX
A	1.03	1.17	0.0406	0.0461
b	0.34	0.48	0.0134	0.0189
c	0.824	0.970	0.0324	0.0382
D	4.80	5.40	0.1890	0.2126
D1	4.11	4.31	0.1618	0.1697
D2	4.80	5.00	0.1890	0.1969
E	5.59	6.15	0.2343	0.2421
E1	5.65	5.85	0.2224	0.2303
E2	1.60	-	0.0630	-
e	1.27 BSC		0.05 BSC	
L	0.05	0.25	0.0020	0.0098
L1	0.38	0.50	0.0150	0.0197
L2	0.38	0.50	0.0150	0.0197
H	3.30	3.50	0.1299	0.1378
I	-	0.18	-	0.0070