

Energy Management Energy Analyzer Type EM111

CARLO GAVAZZI

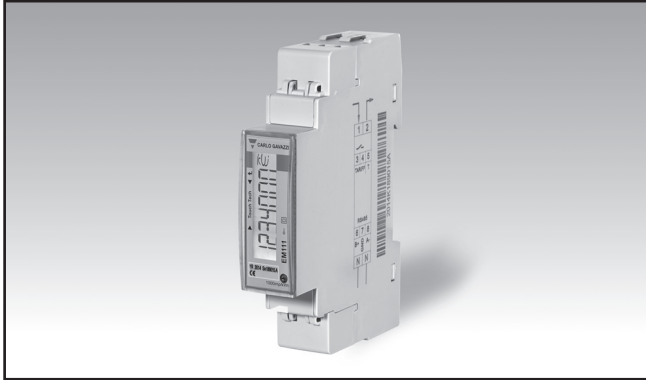

- Easy connection or wrong current direction detection
- Compliant with the international accuracy standard IEC/EN62053-21, and the IEC/EN61557-12 performance requirements (active power and active energy).
- Certified according to MID Directive (option PF only): see "how to order" below

- Single phase energy analyzer
- Class 1 (kWh) according to EN62053-21
- Class B (kWh) according to EN50470-3
- Accuracy $\pm 0.5\%$ RDG (current/voltage)
- Current measurement via 333 mV current sensor up to 600 A (MV5)
- Current measurement via CT up to 300 A (AV5)
- Rated primary current: 32 A (AV7, AV8)
- Max primary current: 45 A (AV7, AV8)
- Max cable cross section: 6 mm²
- Backlit LCD display with integrated touch key-pad
- Energy readout on display: 7 digit
- Variable readout on display: 4 digit
- Energy measurement: kWh and kvarh (imported/exported); kWh+ by 2 tariffs
- System variables, kW, kvar, V, A, PF, Hz, kWdmd, kWdmd peak
- Self power supply
- Dimensions: 1-DIN module
- Protection degree (front): IP51
- Pulse output (by open collector PNP)
- RS485 Modbus port
- M-Bus port
- Digital input (for tariff management)

Product description

Single-phase energy analyzer with backlit LCD display with integrated touch keypad. Particularly indicated for active energy metering and for cost allocation in

applications up to 32 A (direct connection) or up to 300 A (CT connection) or up to 600 A (333 mV current sensor), with dual tariff management availability. It can measure

imported and exported energy or be programmed to sum them into a unique totalizer. Housing for DIN-rail mounting, with IP51 degree protection. The meter

is provided with pulse output proportional to the active energy being measured, RS485 Modbus port or M-Bus port.

MID Certified according to MID Directive, Module B and Module D of Annex II, for legal metrology relevant to active electrical energy meters (see Annex V, MI003, of MID). Can be used for fiscal (legal) metrology.

How to order EM111-DIN AV8 1 X O1 PF B

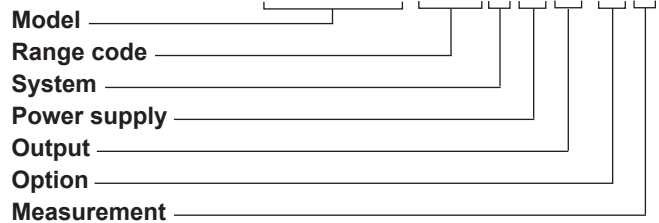

Type Selection

Range code	System	Power supply	Output
AV8: 230VLN AC - 5(45)A (Direct connection up to 32 A)	1: 1-phase 2-wire	X: Self power supply	O1: pulse output S1: RS485 Modbus port M1: M-Bus port
Option	Measurement		
PF: Certified according to MID Directive. Can be used for fiscal (legal) metrology.	A: The power is always integrated (both in case of positive imported and negative exported power) and the total energy meter is certified according to MID. Operating temperature: from -25 to +55°C/from -13 to +131°F		
	B: Only the total positive energy meter is certified according to MID. Operating temperature: from -25 to +55°C/from -13 to +131°F		
	A70: The power is always integrated (both in case of positive imported and negative exported power) and the total energy meter is certified according to MID. Operating temperature: from -25 to +70°C/from -13 to +158°F		
	B70: Only the total positive energy meter is certified according to MID. Operating temperature: from -25 to +70°C/from -13 to +158°F		

STANDARD

Not certified according to MID Directive. Cannot be used for fiscal (legal) metrology.

How to order EM111-DIN AV8 1 X O1 X

Model _____
 Range code _____
 System _____
 Power supply _____
 Output _____
 Option _____

Type Selection

Range code	System	Power supply	Output
AV8: 230VLN ac - 5(45)A (Direct connection up to 32 A)	1: 1-phase 2-wire	X: Self power supply	O1: pulse output S1: RS485 Modbus port M1: M-Bus port
AV7: 120VLN ac - 5(45)A (Direct connection up to 32 A). Available on request (MOQ 100 pcs)			
AV5: 230VLN ac - 5(6)A (CT connection), S1 output only			
MV5: 230VLN ac - 333 mV (current sensor connection), S1 output only			
Option			
X:	none		

Input specifications

Rated Inputs			Power	0.1 kW or kvar
Current type			Frequency	0.1Hz
	AV7, AV8	1-phase loads, direct connection up to 32 A	PF	0.001
	AV5	1-phase loads, CT connection (5A) Note: max CT ratio = 60 (300 A)	Energies (positive)	0.1 or 0.001 kWh or kvarh
	MV5	1-phase loads, current sensor connection (333 mV) Note: max primary current = 600 A	Energies (negative)	0.1 or 0.001 kWh or kvarh
Nominal current range			Energy additional errors	
	AV7, AV8	5(45)A, Ib 5 A, I _{max} 45 A, I _{min} 0.25 A	Influence quantities	According to EN62053-21
	AV5	5 (6) A, I _n 5A, I _{max} 6 A, I _{min} 0.25 A.	Temperature drift	≤200ppm/°C
	MV5	333 mV (400 mV max)	Sampling rate	4096 samples/s @ 50Hz 4096 samples/s @ 60Hz
Nominal voltage			Display and touch key-pad	
	AV5, AV8	230 VLN -30% +20 %	Type	Backlit LCD, 7-digit, h 6 mm
	AV7	120 VLN -20% +20%	Read-out	Energy: 7 digit. Variables: 4 digit
	MV5	230 VLN -30% +20 %	Touch key	2 (Enter/DOWN and UP).
Note		EM111 with direct connection (AV7, AV8) can be used up to 45 A if a 6 mm ² section wire complies with local regulations and/or installation needs.	Max. and Min. indication	Max. 9 999 999 Min. 0.00
Accuracy (@25°C ±5°C, R.H. ≤60%, 45 to 65 Hz)			Memory energy storage	
Energies			Energy	10 ¹⁰ cycles. Energy value is saved every time the less significant digit increases.
Active energy		Class 1 according to EN62053-21 Class B (kWh) according to EN50470-3 (option PF only)	Programming parameters	10 ¹⁰ cycles. When a parameter is modified, only the relevant memory cell is overwritten
Reactive energy		Class 2 according to EN62053-23	LEDs	Flashing red light pulses according to EN50470-3, EN62052-11
Start-up current			Pulse weight	AV7, AV8 1000 pulses/kWh (max. frequency: 11 Hz) AV5 Depending on CT ratio: CT ≤ 25: 1000 pulse/kWh 25 < CT < 60: 100 pulses/kWh MV5 Depending on primary current: Primary current ≤ 125 : 1000 pulses/kWh Primary current >125: 100 pulses/kWh
	AV7, AV8	20 mA, positive or negative	Note	Fix orange light: wrong current direction only with PFB option or with "B" measurement selection in case of X option
	AV5	10 mA, positive or negative Self-consumption is not measured.	Current overloads	
	MV5	0.666 mV	Continuous	AV7, AV8 45 A AV5 6 A MV5 400 mV
Start-up voltage			For 10ms	AV7, AV8 1350 A AV5 120 A
	AV5, AV8	161 VLN	Voltage Overloads	
	AV7	96 VLN	Continuous	1.2 Un
	MV5	161 VLN	For 500ms	2 Un
Resolution		Display	Input impedance	
Current		0.1 A	Voltage input	2.8 Mohm
Voltage		0.1 V	Current input	AV7, AV8 < 0.5 VA AV5 <0.05 VA MV5 1 kohm
Power		0.01 kW or kVar		
Frequency		0.1 Hz		
PF		0.01		
Energies (positive)		0.01 kWh or kvarh		
Energies (negative)		0.01 kWh or kvarh Serial communication		
Current		0.001 A		
Voltage		0.1 V		

Digital input specifications

Digital inputs	Free of voltage contact	Overload	In case a voltage is erroneously applied to the digital input, the input is not damaged up to 30 V ac/dc.
Function	Tariff management (switch between t1-t2)		
Number of inputs	1		
Contact measurement voltage	5 V		
Input impedance	1kohm		
Contact resistance	≤ 1kohm, close contact ≥ 100kohm, open contact		

Output specifications

RS485 serial port	RS485 by screw connection.	Other	69999999
Function	For communication of measured data, programming parameters		Available functions: wild card, header, initialisation
Protocol	Modbus RTU (slave function)		SND_NKE, and req_uds management. Management of primary address modification via M-Bus.
Baud rate	9.6, 19.2, 38.4, 57.6, 115.2 kbaud,		VIF, VIFE, DIF and DIFE: see protocol
parity control	even or no parity,	Note	not available with AV5 and MV5 range code
Address	1 to 247 (default: 1)		
Driver input capability	1/8 unit load. Maximum 247 transceivers on the same bus.	Static output	
		Purpose	For pulse output proportional to the active energy (kWh)
Data refresh time	1 s	Pulse rate	Selectable in multiple of 100
Read command	50 words available in 1 read command	Pulse ON duration	Max 1000 or 3000 pulses/kWh according to pulse ON duration
M-Bus port	M-Bus by screw connection.	Output type	Selectable: 30ms or 100 ms according to EN62052-31
Function	For communication of measured data	Load	open collector PNP
Protocol	M-Bus according to EN13757-3		V_{ON} 1 VDC max. 100mA
Baud rate	0.3, 2.4, 9.6 kbaud	Note	V_{OFF} 80 VDC max. not available with AV5 and MV5 range code
Meters in the M-Bus network	250		
Primary address	Selectable		
Secondary address	Univocally defined in each unit		
Secondary address	from 50000000 to		

General specifications

Operating temperature PF option (standard or with suffixes from 01 to 60)	From -25 to +55°C/from -13 to +131°F	Metrology	EN62053-21, EN62053-23, EN50470-3 (PF option only) IEC/EN61557-12 (active power and active energy, MID models only)
PF option (with suffixes from 61 to 99)	From -25 to +70°C/from -13 to +158°F	Approvals	CE, UKCA, MID (PF option only), cULus (AV7 option only)
X option	From -25 to +65°C/from -13 to +149°F indoor, (R.H. from 0 to 90% non-condensing @ 40°C)	Connections Cable cross-section area	Measuring inputs: max. 6 mm ² with/without metallic cable ferrule; Max. screw tightening torque: 1.1 Nm 1.5 mm ² , Min./Max. screws tightening torque: 0.4 Nm
Storage temperature	-30°C to +80°C (R.H. < 90% non-condensing @ 40°C)	Other terminals	
Overvoltage category	Cat. III	Housing Dimensions (WxDxH)	17,5 x 63 x 91,5 mm
Insulation (for 1 minute)	4000 VAC RMS between measuring inputs and digital/serial output (see table) 4000 VAC RMS	Material	PBT, self-extinguishing: UL 94 V-0
Dielectric strength	4000 VAC RMS for 1 minute	Sealing covers	Included
EMC	According to EN62052-11 (X option) According to EN50470-1 (PF option)	Mounting	DIN-rail
Standard compliance Safety	EN62052-11 (X option) EN50470-1 (PF option)	Protection degree Front	IP51
		Screw terminals (cable inputs)	IP20
		Weight	Approx. 80 g (packing included)

Power supply specifications

Power supply	self power supply	Power consumption	≤ 1.0W, ≤ 8VA
---------------------	-------------------	--------------------------	---------------

Insulation (for 1 minute) between inputs and outputs

AV7, AV8 model	Measuring input	Digital or serial output	Digital input
Measuring input	-	4 kV	4 kV
Digital or serial output	4 kV	-	-
Digital input	4 kV	-	-

AV5 model	CT input (5 A)	Voltage input	Serial output	Digital input
CT input (5 A)	-	2 kV	4 kV	4 kV
Voltage input	2 kV	-	4 kV	4 kV
Serial output	4 kV	4 kV	-	4 kV
Digital input	4 kV	4 kV	4 kV	-

MV5 model	CT input (333 mV)	Voltage input	Serial output	Digital input
CT input (333 mV)	-	2 kV	4 kV	4 kV
Voltage input	2 kV	-	4 kV	4 kV
Serial output	4 kV	4 kV	-	4 kV
Digital input	4 kV	4 kV	4 kV	-

MID compliance (PF option only)

Accuracy	0.9 $U_n \leq U \leq 1.1 U_n$; 0.98 $f_n \leq f \leq 1.02 f_n$; f_n : 50 Hz; cos ϕ : 0.5 inductive to 0.8 capacitive. Class B Considering listed I_b or I_n values
Operating temperature	PF option (standard or with suffixes from 01 to 60): from -25 to $+55^\circ\text{C}$ /from -13 to $+131^\circ\text{F}$ PF option (with suffixes from 61 to 99): from -25 to $+70^\circ\text{C}$ /from -13 to $+158^\circ\text{F}$ X option: from -25 to $+65^\circ\text{C}$ /from -13 to $+149^\circ\text{F}$ indoor (R.H. from 0 to 90% non-condensing @ 40°C)
EMC compliance	E2
Mechanical compliance	M2

Accuracy (according to EN62053-21 and EN62053-23) - AV5 model

kWh, accuracy (RDG) depending on the current

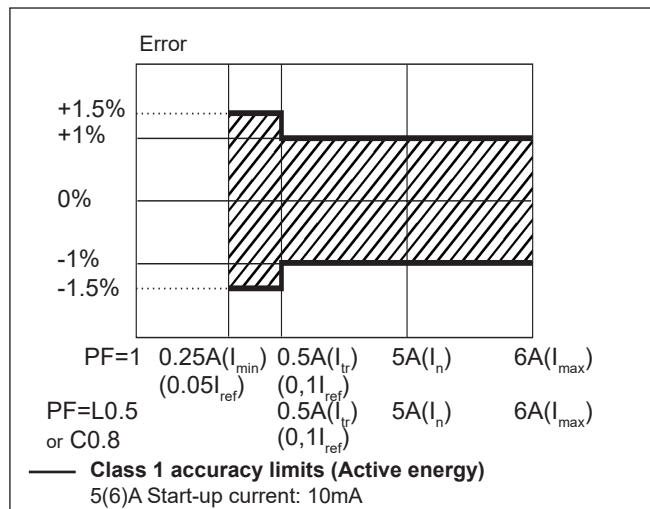

kvarh, accuracy (RDG) depending on the current

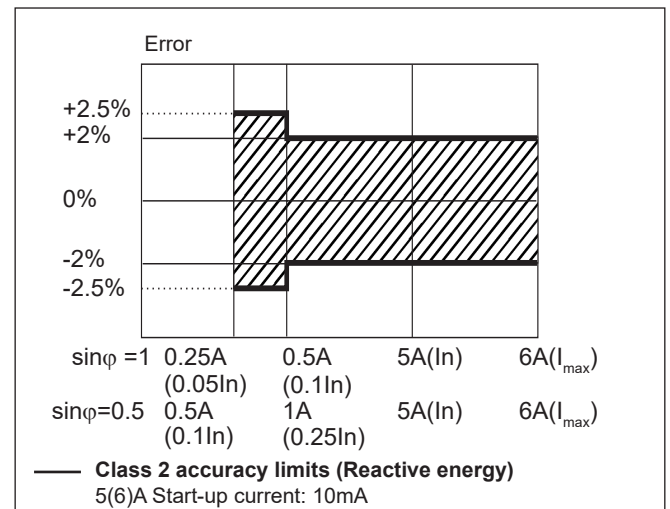

Accuracy (according to EN50470-3 and EN62053-23) - AV7/AV8 model

kWh, accuracy (RDG) depending on the current

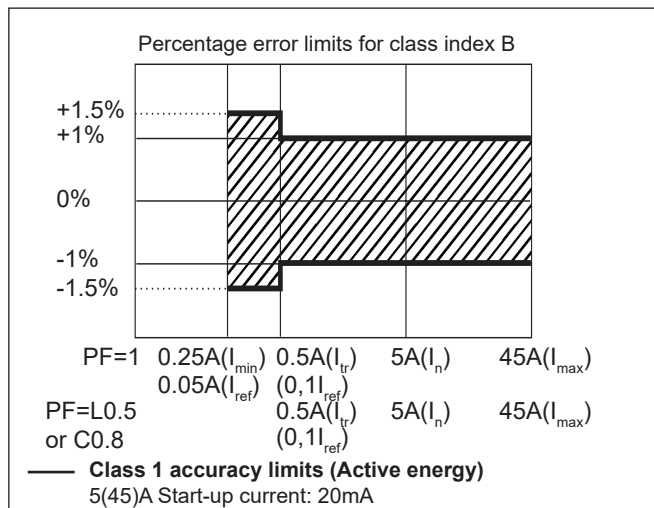

kvarh, accuracy (RDG) depending on the current

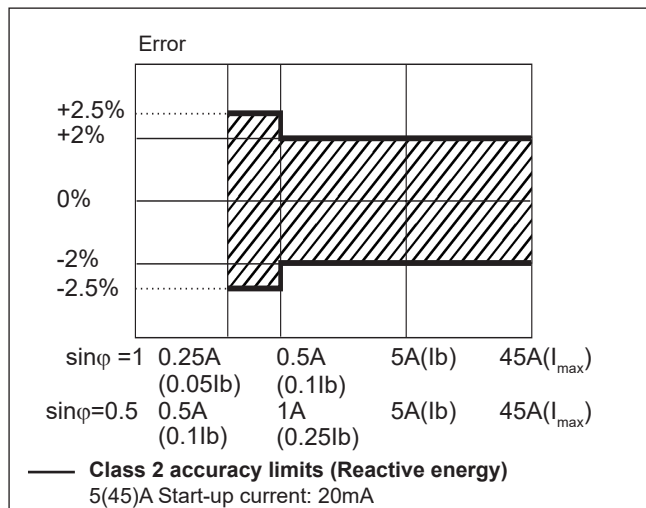

Measurement accuracy according to IEC/EN61557-12 (MID versions)

Active power

Performance class 1

Active energy

Performance class 2

Display pages

No	Variable	“Full” mode	“Easy” mode	Note
0	kWh+ (imported)	X	X	In PF version (MID) this is the only certified energy meter. In PFA version and in X version with Measurement menu set to “A”, this is considering the total energy without considering the current direction.
1	kWh- (exported)	X	X	In PFB version and in X version with Measurement menu set to “B”
2	kW	X	X	
3	V	X	X	
4	A	X	X	
5	PF	X		
6	Hz	X		
7	kvarh+ (imported)	X		In PFA version and in X version with Measurement menu set to “A”, this is considering the total positive reactive energy without considering the current direction.
8	kvarh- (exported)	X		In PFB version and in X version with Measurement menu set to “B”
9	kvar	X		
10	kW dmd	X		
11	kW dmd peak	X		
12	kWh (t1)	X	X	Only relevant to kWh+, with Tariff menu set to ON
13	kWh (t2)	X	X	Only relevant to kWh+, with Tariff menu set to ON

X= available

List of available menus

Menu name and description		Range	Default setting
PASS	Password request	From 0000 to 9999	0000
nPASS	New password	From 0000 to 9999	0000
Ct Ratlo (AV5)	Current transformer ratio	From 1 to 60	20
PrI Curr (MV5)	Primary current	From 1 to 600	100
MEASurE	Measurement type (A=easy connection; B=bidirectional, imported and exported energy). Not available in PFA and PFB versions (MID)	A; b	A
P int	Integration time for Wdmd calculation	1 to 30 min	1
Mode	Selection of complete or simplified set of variables on display	Full or Easy	Full
Tariff	Tariff enabling	Yes/No	No
PULSE (O1 option)	Selection of pulse ON duration	30 or 100 ms	30
	Selection of the pulse weight (multiplies of 100 pulses/kWh)	100 to 1000 (if duration is 100ms) 100 to 3000 (if 30 ms)	1000
Address (S1 option)	Modbus serial address	1 to 247	01
Baud (S1)	Modbus baud rate	9.6; 19.2; 38.4; 57.6, 115.2 kbps	9.6
Parity (S1)	Modbus parity	No/even	No
PrI Add (M1 option)	M-Bus primary address	1 to 250	0
Baud (M1)	M-Bus baud rate	0.3; 2.4; 9.6 kbps	2.4
RESEt	Allow the reset of tariff meters and W dmd peak (kWh/kvarh partial meter reset available only via serial communication)	Yes/No	No
End	Exit to measuring mode		

Note: after the confirmation of a new parameter value, the value is stored in the memory without the need to exit the programming mode.

Additional available information on the display (*)

Type	Page	Description
Info page 1	YEA _r (2013)	Year of production
Info page 2	SE _R I _A L (dddnnnA)	Serial number (ddd= day of the year; nnn=progressive number; A= production line, internal use only)
Info page 3	rEV (A.01)	Firmware revision
Info page 4	Ct Ra _t Io (AV5)	Current transformer ratio
Info page 5	PrI Cu _r r (MV5)	Primary current
Info page 6	MEASu _r E	Measurement type
Info page 7	P int	Integration time for W _d md calculation
Info page 8	ModE	Set of variables on display
Info page 9	tArI _F F	Tariff enabling
Info page 10 (O1)	PULSE	Pulse ON duration
		Pulse weight
Info page 10 (S1)	Ad _d rESS	Modbus serial address
Info page 11 (S1)	bAu _d	Modbus baud rate
Info page 12 (S1)	PA _r ItY	Modbus parity
Info page 10 (M1)	PrI Ad _d	M-Bus primary address
Info page 11 (M1)	bAu _d	M-Bus baud rate
Info page 13	ChECK_ _S	FW checksum

(*) can be reached by pressing simultaneously the 2 touch keys

AV7, AV8 wiring diagrams

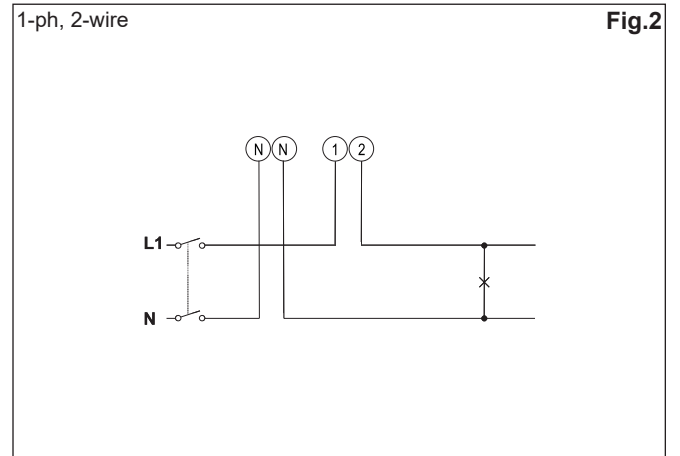
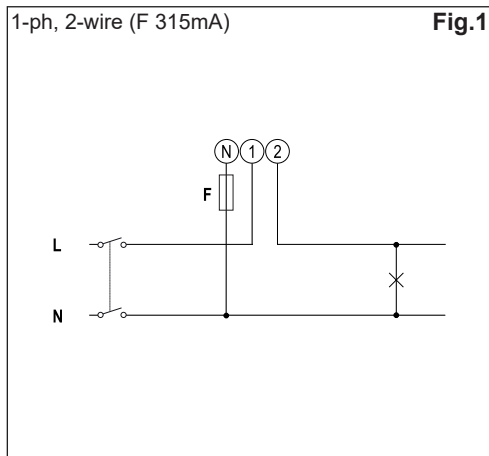

AV5 wiring diagrams

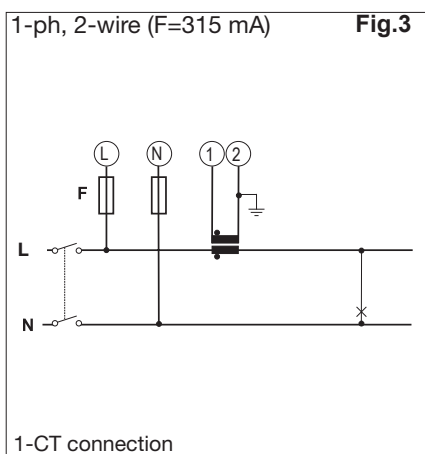

MV5 wiring diagrams

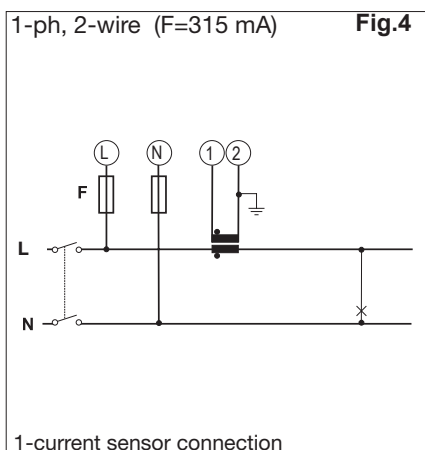

Input/output communication

Open collectors output

Fig.4

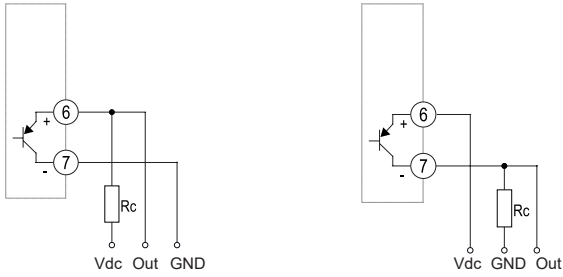

The load resistance (R_c) must be designed so that the closed contact current is under 100 mA (V_{on} is equal to 1 V dc). DC voltage (V_{off}) must be less than or equal to 80 V.

Digital Input

Fig.5

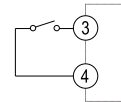

RS485 Modbus communication port

Fig.6

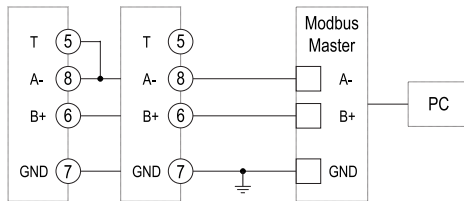

Additional instruments with RS485 are connected in parallel. The serial output must only be terminated on the last network device connecting terminals A- and T. For connections longer than 1000 m use a signal repeater. Maximum 247 transceivers on the same bus.

M-Bus communication port

Fig.7

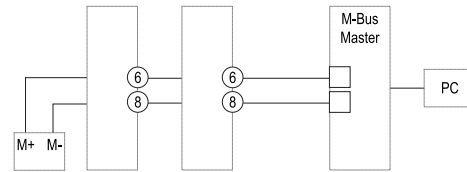

Front panel description

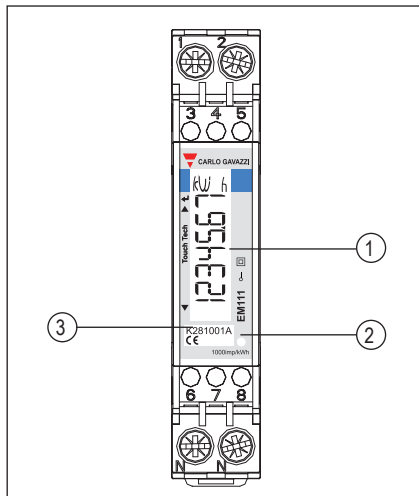

1. **Display**
Backlit LCD display with touch key-pad.
Upper part: enter
2. **LED**
LED proportional to kWh reading
3. **Serial number and MID data**
Area reserved to serial number and MID-relevant data in PF versions

Dimensions (mm)

