



OD2-P250W150I0

OD Value

DISPLACEMENT MEASUREMENT SENSORS

SICK
Sensor Intelligence.



Illustration may differ



Ordering information

Type	Part no.
OD2-P250W150I0	6036645

Other models and accessories → www.sick.com/OD_Value

Detailed technical data

Mechanics/electronics

Supply voltage V_s	DC 12 V ... 24 V
Power consumption	$\leq 2.88 \text{ W}^{1)}$
Warm-up time	$\leq 30 \text{ min}$
Housing material	PBT
Window material	PMMA
Connection type	Male connector, M12, 8-pin, swivel connector unit
Indication	Distance bar graph, up to 8 status LEDs
Weight	70 g
Enclosure rating	IP67
Protection class	III

¹⁾ Without load, with current output.

Performance

Measuring range	100 mm ... 400 mm ¹⁾
Target	Natural objects
Repeatability	75 $\mu\text{m}^{1) 2) 3)}$
Linearity	$\pm 750 \mu\text{m}^{2) 4) 5)}$
Response time	$\geq 1 \text{ ms}$
Measuring frequency	$\leq 1.33 \text{ kHz}^{1)}$

¹⁾ 6 % ... 90 % remission.

²⁾ At averaging function medium.

³⁾ Constant ambient conditions.

⁴⁾ Measurement on 90 % remission (ceramic, white).

⁵⁾ When calibrated in the application regularly.

⁶⁾ Wavelength: 655 nm, max. output: 1 mW.

Output time	≥ 0.75 ms
Light source	Laser, red
Laser class	2 (IEC 60825-1:2014, EN 60825-1:2014) ⁶⁾
Typ. light spot size (distance)	1.8 mm x 3.5 mm (250 mm)
Additional function	Mean-value setting 1 ... 64x, automatic sensitivity adjustment, Analog outputs can be taught in, Invertable analog output, Teach-in of digital output, Invertable switching output, multifunctional input: laser-off / external teach-in / trigger, switching mode: distance to object (DtO), switching mode: window (Wnd)

- 1) 6 % ... 90 % remission.
 2) At averaging function medium.
 3) Constant ambient conditions.
 4) Measurement on 90 % remission (ceramic, white).
 5) When calibrated in the application regularly.
 6) Wavelength: 655 nm, max. output: 1 mW.

Interfaces

Digital output	Number	2 ¹⁾
	Type	PNP
	Maximum output current I _A	≤ 100 mA
Analog output	Number	1
	Type	Power output
	Current	4 mA ... 20 mA, ≤ 300 Ω
	Resolution	16 bit
Multifunctional input (MF)		1 x MF ²⁾

- 1) PNP: HIGH = V_S - (< 2 V) / LOW = < 2 V; NPN: HIGH = < 2 V / LOW = V_S.
 2) MF can be used as laser-off, trigger, external teach-in, or deactivated; response time ≤ 3 ms.

Ambient data

Ambient temperature operation	-10 °C ... +40 °C
Ambient storage temperature	-20 °C ... +60 °C
Relative air humidity (non-condensing)	35 % ... 95 %
Temperature drift	± 0.08 % FS/K (FS = Full Scale = Measuring range of sensor)
Typ. Ambient light immunity	Artificial light: ≤ 3,000 lx Sunlight: ≤ 10,000 lx
Vibration resistance	10 Hz ... 55 Hz (amplitude 1.5 mm, x-, y-, z-axis 2 hours each)
Shock resistance	50 G (x, y, z axis 3 times each)

Classifications

ECl@ss 5.0	27270801
ECl@ss 5.1.4	27270801
ECl@ss 6.0	27270801
ECl@ss 6.2	27270801
ECl@ss 7.0	27270801
ECl@ss 8.0	27270801
ECl@ss 8.1	27270801

OD2-P250W150I0 | OD Value

DISPLACEMENT MEASUREMENT SENSORS

ECl@ss 9.0	27270801
ETIM 5.0	EC001825
ETIM 6.0	EC001825
UNSPSC 16.0901	41111613

Dimensional drawing (Dimensions in mm (inch))

OD2-x250W150xx

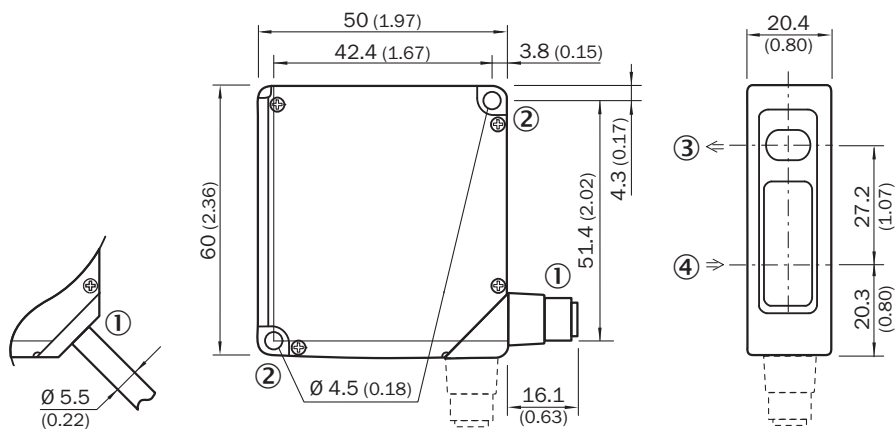

- ① 2 m cable or M12 connector; 90° rotatable
- ② Mounting hole, Ø 4.5 mm
- ③ Optical axis, sender
- ④ Optical axis, receiver

Connection type

OD2-xxxxxA0 OD2-xxxxxC0 OD2-xxxxxI0 OD2-xxxxxU0 connector M12, 8-pin

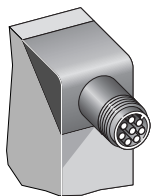

Connection diagram

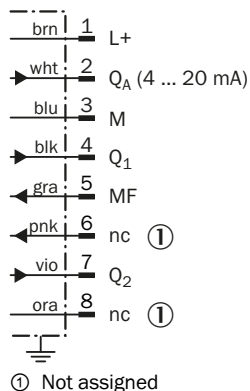

Adjustment possible

OD2-xxxxxxIx

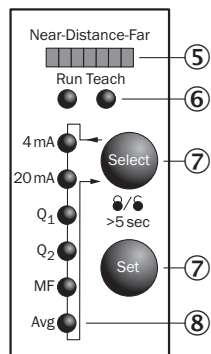

- ⑤ Distance indicator
- ⑥ Mode indicator (Run/Teach)
- ⑦ Operating elements
- ⑧ Status indicator in- and outputs (Run-mode)/menu indicator (Teach-mode)

Light spot size

OD2-x250W150xx

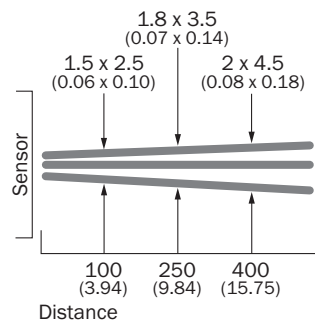

All dimensions in mm (inch)

Linearity

OD2-x250xxxx

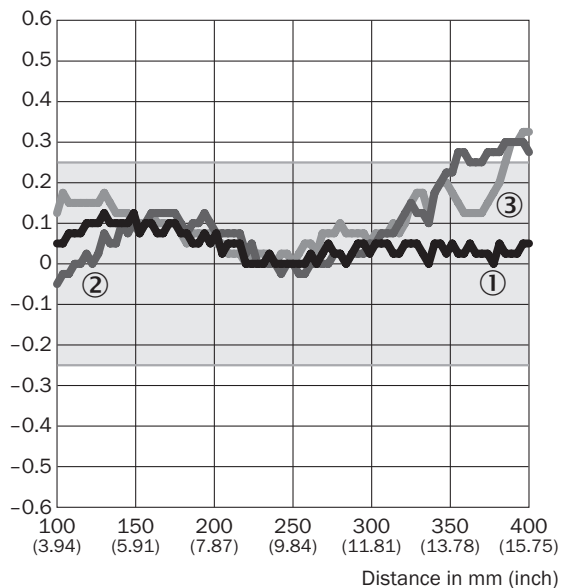

Linearity [%FS]



- ① White ceramic
- ② Black paper
- ③ Stainless steel

Recommended accessories

Other models and accessories → www.sick.com/OD_Value

	Brief description	Type	Part no.
Mounting brackets and plates			
	Stainless-steel mounting bracket, stainless steel	BEF-WN-OD1000	4089813
Plug connectors and cables			
	Head A: female connector, M12, 8-pin, straight Head B: Flying leads Cable: special color code, PVC, shielded, 2 m	DOL-1208-G02MF	6020663

Recommended services

Additional services → www.sick.com/OD_Value

	Type	Part no.
Warranty extensions		
<ul style="list-style-type: none"> • Product area: Identification solutions Vision Distance sensors Detection and ranging solutions • Range of services: The services correspond to the scope of the statutory manufacturer warranty (SICK general terms and conditions of purchase) Long-term protection for calculable lump sum. • Duration: Five-year warranty from date of purchase. 	Five-year extended warranty	1680671
Commissioning		
<ul style="list-style-type: none"> • Product area: Displacement measurement sensors • Range of services: Inspection of connection and mounting, optimization of parameters of SICK product as well as verification tests set-up of previously defined functions of the scaling of the analog measuring range, switching point position, hysteresis, measuring frequency, measured value filter, signal quality, evaluation function, or communication interface • Documentation: Archiving of product parameters in a SICK database Documentation of performance Creation of a commissioning log • Duration: Additional work will be invoiced separately based on time spent • Travel expenses: The prices do not include expenses or costs for the travel time travel costs, such as flight or hotel expenses, are not included 	DT20 Hi/OD/OL commissioning	1612241

SICK AT A GLANCE

SICK is one of the leading manufacturers of intelligent sensors and sensor solutions for industrial applications. A unique range of products and services creates the perfect basis for controlling processes securely and efficiently, protecting individuals from accidents and preventing damage to the environment.

We have extensive experience in a wide range of industries and understand their processes and requirements. With intelligent sensors, we can deliver exactly what our customers need. In application centers in Europe, Asia and North America, system solutions are tested and optimized in accordance with customer specifications. All this makes us a reliable supplier and development partner.

Comprehensive services complete our offering: SICK LifeTime Services provide support throughout the machine life cycle and ensure safety and productivity.

For us, that is “Sensor Intelligence.”

WORLDWIDE PRESENCE:

Contacts and other locations –www.sick.com