

IMC-350

10/100Mbps Miniature Media Converter



Features

- Metal enclosure with compact size
- Industrial grade design that supports an extended operating temperature (IMC-350I series)
- IEEE802.3af compliant (IMC-350I series as PoE-PD)
- Supports Link Fault Pass Through functionality (LFPT) (IMC-350-SFP)
- Centralized powered IMC-318I chassis

Introduction

The IMC-350 series offers the most compact media converters. They can extend the 10 and 100Mbps twisted-pair network segments up to 80km over fiber technology. Supporting both 10/100 auto negotiation on the copper port and 100Mbps full-duplex on the fiber port, the IMC-350 series serves as media and data rate converter.

With a variety of model types offering play-n-plug feature and multiple powering options, the IMC-350 series is an easy and convenient choice for many applications. The IMC-350I series is of industrial grade and can operate in a wide temperature range. Multiple power options, including the IEEE802.3af Power-over-Ethernet standard, allow the IMC-350I series to function as a power device. Its AC adapter and USB connectivity offer unsurpassed flexibility for a variety of installation needs.

The IMC-350-SFP supports Link Fault Pass Through (LFPT) functionality. LFPT is a troubleshooting feature that combines TX LinkLoss (twisted pair, copper interface) and FX LinkLoss (fiber, fiber interface) from both the local and remote IMC Networks media converters, when used in pairs. This feature, when enabled, will pass a link fault through the device at each segment. If a link fails on one interface of the media converter, the media converter will force the link down on its link partner and then forward it to the next interface.

Specifications

Technical	
IEEE 802.3, 802.3u	
IEEE 802.3af compliant PoE-PD (IMC-350I)	
Supports jumbo frames up to 1916 bytes	
Plug-and-play operation	
Status LED	
AutoCross for MDI/MDIX	
Supports Link Fault Pass Through (LFPT) (IMC-350-SFP)	
Terminal DC power block (IMC-350I)	
Power Input	
100 – 240V DC, 50-60Hz, 0.3A (IMC-350/350I AC input)	
7 – 50V DC, 1A-0.1A (IMC-350I DC input)	
5V DC (Barrel Connector)	
50V (PoE Maximum supply voltage) (IMC-350I PoE-PD input)	

Environment	
Operating Temperature	0 to +50 °C (+32 to +122 °F) (IMC-350)
	-40 to +80 °C (-40 to +185 °F) (IMC-350I DC or PoE-PD input)
	-10 to +50 °C (+14 to +122 °F) (IMC-350I AC input)
Storage Temperature	0 to +50 °C (+32 to +122 °F) (IMC-350 series)
	-40 to +85 °C (-40 to +185 °F) (IMC-350I series)
Operating Humidity	5 ~ 95% (non-condensing)
	0 ~ 10,000 ft. altitude
MTBF	796,650 Hours
Mechanical	
Dimensions (H x W x D)	2.11 x 4.57 x 8.51 cm (0.83 x 1.80 x 3.35 in)
Weight	0.317 kg (0.7 lb)
Certifications	
CE, FCC Class B, UL/cUL, CSA (IMC-350, IMC-350I using DC terminal or PoE-PD)	
CE, FCC Class A, UL/cUL, CSA (IMC-350I using any DC jack)	

Dimensions

Unit: mm [inch]

IMC-350

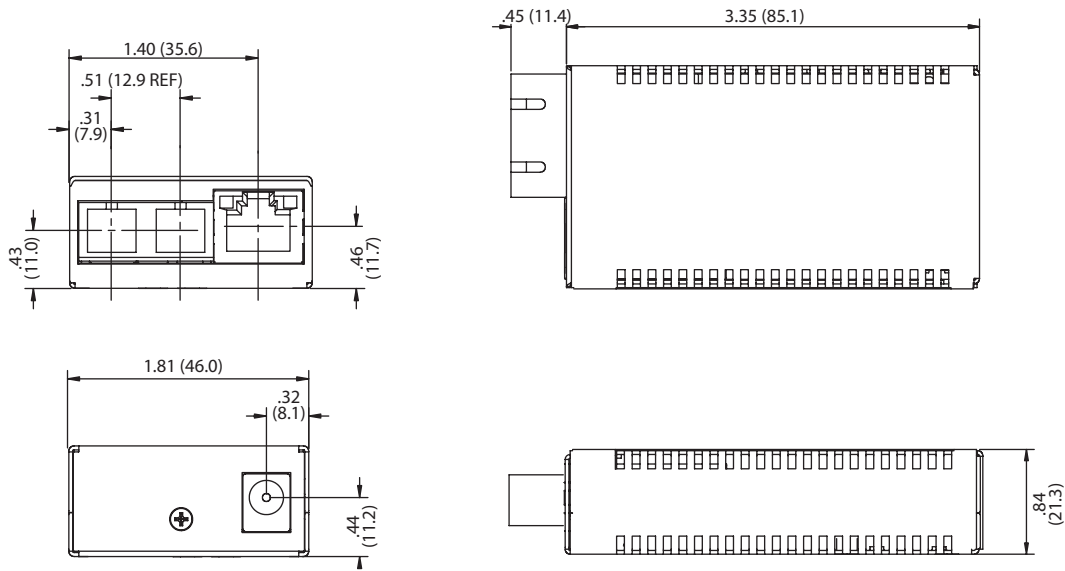

IMC-350I

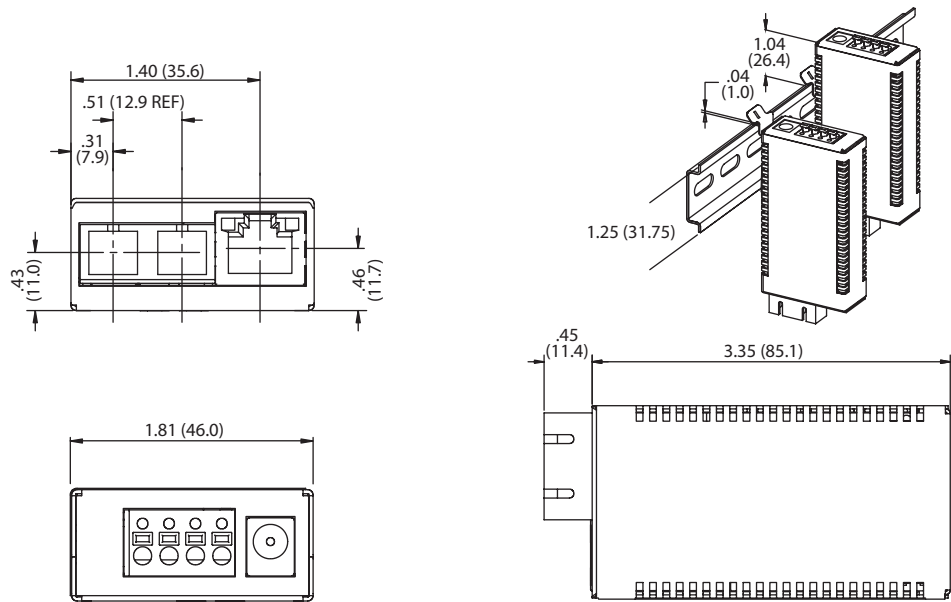

Ordering Information

10/100 Mbps Miniature Media Converter

Part Number	B+B Model Name	Ethernet Speed	Optical Mode	Wavelength	Distance	Optical Connector	Power Adapter
IMC-350-M8ST	854-10620	10/100 Mbps	Multi-Mode	850 nm	2 km	ST	-
IMC-350-M8ST-PS	855-10620	10/100 Mbps	Multi-Mode	850 nm	2 km	ST	Yes
IMC-350-M8	854-10621	10/100 Mbps	Multi-Mode	850 nm	2 km	SC	-
IMC-350-M8-PS	855-10621	10/100 Mbps	Multi-Mode	850 nm	2 km	SC	Yes
IMC-350-MMST	854-10622	10/100 Mbps	Multi-Mode	1300 nm	5 km	ST	-
IMC-350-MMST-PS	855-10622	10/100 Mbps	Multi-Mode	1300 nm	5 km	ST	Yes
IMC-350-MM	854-10623	10/100 Mbps	Multi-Mode	1300 nm	5 km	SC	-
IMC-350-MM-PS	855-10623	10/100 Mbps	Multi-Mode	1300 nm	5 km	SC	Yes
IMC-350-USB	854-10621-USB	10/100 Mbps	Multi-Mode	850 nm	2 km	SC	Powered by USB
IMC-350-SEST	854-10624	10/100 Mbps	Single-Mode	1310 nm	40 km	ST	-
IMC-350-SEST-PS	855-10624	10/100 Mbps	Single-Mode	1310 nm	40 km	ST	Yes
IMC-350-SE	854-10625	10/100 Mbps	Single-Mode	1310 nm	40 km	SC	-
IMC-350-SE-PS	855-10625	10/100 Mbps	Single-Mode	1310 nm	40 km	SC	Yes
IMC-350-SL	854-10627	10/100 Mbps	Single-Mode	1310 nm	80 km	SC	-
IMC-350-SL-PS	855-10627	10/100 Mbps	Single-Mode	1310 nm	80 km	SC	Yes
IMC-350-SSMR-PS	855-10651	10/100 Mbps	Single-Strand	1550T/1310R	2 km	SC	Yes
IMC-350-SSMT-PS	855-10650	10/100 Mbps	Single-Strand	1310T/1550R	2 km	SC	Yes
IMC-350-SSR-PS	855-10653	10/100 Mbps	Single-Strand	1550T/1310R	20 km	SC	Yes
IMC-350-SST-PS	855-10652	10/100 Mbps	Single-Strand	1310T/1550R	20 km	SC	Yes
IMC-350-SFP	854-10619	10/100 Mbps	Various	Various	Various	SFP	-
IMC-350-SFP-PS	855-10619	10/100 Mbps	Various	Various	Various	SFP	Yes

Industrial Grade 10/100 Mbps Miniature Media Converter w/ PoE/PD Feature

Part Number	B+B Model Name	Ethernet Speed	Optical Mode	Wavelength	Distance	Optical Connector	Power Adapter
IMC-350I-M8ST	854-19720	10/100 Mbps	Multi-Mode	850 nm	2 km	ST	-
IMC-350I-M8ST-PS	855-19720	10/100 Mbps	Multi-Mode	850 nm	2 km	ST	Yes
IMC-350I-M8	854-19721	10/100 Mbps	Multi-Mode	850 nm	2 km	SC	-
IMC-350I-M8-PS	855-19721	10/100 Mbps	Multi-Mode	850 nm	2 km	SC	Yes
IMC-350I-MMST	854-19722	10/100 Mbps	Multi-Mode	1300 nm	5 km	ST	-
IMC-350I-MMST-PS	855-19722	10/100 Mbps	Multi-Mode	1300 nm	5 km	ST	Yes
IMC-350I-MM	854-19723	10/100 Mbps	Multi-Mode	1300 nm	5 km	SC	-
IMC-350I-MM-PS	855-19723	10/100 Mbps	Multi-Mode	1300 nm	5 km	SC	Yes
IMC-350I-SEST	854-19724	10/100 Mbps	Single-Mode	1310 nm	40 km	ST	-
IMC-350I-SEST-PS	855-19724	10/100 Mbps	Single-Mode	1310 nm	40 km	ST	Yes
IMC-350I-SE	854-19725	10/100 Mbps	Single-Mode	1310 nm	40 km	SC	-
IMC-350I-SE-PS	855-19725	10/100 Mbps	Single-Mode	1310 nm	40 km	SC	Yes
IMC-350I-SL-PS	855-19730	10/100 Mbps	Single-Mode	1310 nm	80 km	SC	Yes
IMC-350I-SSR	854-19753	10/100 Mbps	Single-Strand	1550T/1310R	20 km	SC	-
IMC-350I-SSR-PS	855-19753	10/100 Mbps	Single-Strand	1550T/1310R	20 km	SC	Yes
IMC-350I-SST	854-19752	10/100 Mbps	Single-Strand	1310T/1550R	20 km	SC	-
IMC-350I-SST-PS	855-19752	10/100 Mbps	Single-Strand	1310T/1550R	20 km	SC	Yes

Accessories

Part Number	Description
806-39105	DIN Rail Clip
806-39628	USB Power Cable, 0.9m (36 in)
806-39629	USB Power Cable, 0.3m (12 in)
806-39650	Barrel Connector Power Cable, 0.3m (12 in)
895-39229	Wall-mount Bracket
806-39720	AC Power Adapter

* SFP fibers sold separately – available at www.advantech.com