

Features

- **Operational range: 30MHz to 1GHz**
- **Allows full evaluation and investigation of the CMX993 and CMX993W quadrature modulators**
- **Access to RF, control and baseband signals via connectors and test points**
- **Differential or single-ended I/Q inputs**
- **Can utilise PE0002 EvKit interface card for PC interface or work with custom interface equipment**
- **Interfaces to CMX910 or CMX981 EvKit**

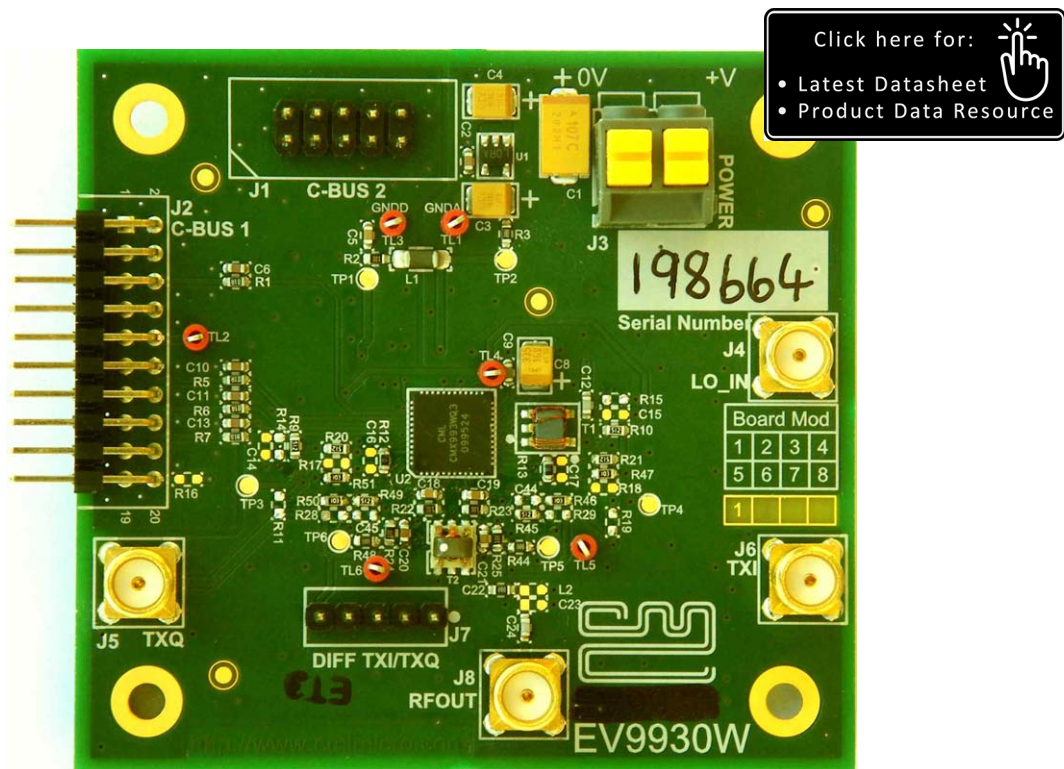

1 Brief Description

The EV9930 and EV9930W EvKits allow for rapid and full evaluation of the CMX993 or the CMX993W Quadrature Modulator IC by providing a populated pcb with access to all RF, baseband and control signals by either connectors or test points. Test access points are available to accept common test equipments such as RF and baseband signal generators and spectrum analysers. Control of the CMX993/CMX993W is by registers, which are accessible over the C-BUS interface (an SPI-like serial interface). A PE0002 Interface Card (not supplied) allows the C-BUS interface to be controlled from a PC, via its USB port. Alternatively, the C-BUS interface can be controlled by an external microprocessor.

RF signal paths are matched by suitable components and the operating frequency range of the EvKit is for RF frequencies between 200MHz and 1GHz. A simple component change allows a lower operating frequency range of 30MHz to 200MHz. The EV9930/EV9930W baseband inputs can be configured to work with the CMX910 AIS Baseband Processor IC or the CMX981 Advanced Digital Radio Baseband Processor IC; standard test equipment or with a custom baseband system.

CONTENTS

<u>Section</u>	<u>Page</u>
1 Brief Description	1
1.1 History	4
2 Preliminary Information	6
2.1 Laboratory Equipment	6
2.1.1 Power Supply	6
2.2 Handling Precautions	6
2.2.1 Static Protection	6
2.2.2 Contents - Unpacking	6
2.3 Approvals	6
3 Quick Start	7
3.1 Make External Connections and Apply Power	7
3.2 Typical Configure	8
3.3 Operate	8
4 Signal Lists	9
5 Circuit Schematics and Board Layouts	13
6 Detailed Description	15
6.1 Hardware Description	15
6.1.1 Quadrature (I/Q) Modulator	15
6.1.2 Local Oscillator (LO)	15
6.1.3 I/Q Baseband Inputs	15
6.1.4 Differential I/Q Interface	16
6.1.5 Power Supply	16
6.2 Software Description	17
6.2.1 The 'CMX993(W) Regs (\$02 - \$08)' Tab	17
6.2.2 The Script Handler Tab	18
6.3 Application Information	19
6.3.1 Typical Performance	19
6.4 Troubleshooting	21
7 Performance Specification	22
7.1 Electrical Performance	22
7.1.1 Absolute Maximum Ratings	22
7.1.2 Operating Limits	22
7.1.3 Operating Characteristics	23

<u>Table</u>	<u>Page</u>
Table 1 Quick-Start Signal Configuration	8
Table 2 Signal List.....	9
Table 3 C-BUS 2 Interface.....	10
Table 4 C-BUS 1 Interface (for PE0002)	11
Table 5 Test Loops	12
Table 6 Test Points	12
Table 7 Possible Errors.....	21
<u>Figure</u>	<u>Page</u>
Figure 1 Block Diagram	5
Figure 2 Typical Evaluation Connections for EV9930/EV9930W	7
Figure 3 PCB Layout: top.....	13
Figure 4 PCB Layout: bottom.....	14
Figure 5 The 'CMX993(W) Regs (\$02 - \$08)' Tab.....	17
Figure 6 The 'Script Handler' Tab.....	18
Figure 7 0dBm Output Level at 450MHz with a single tone input.....	19
Figure 8 +3dBm PEP Output, two-tone input at 450MHz	20
Figure 9 +3dBm PEP Output, two-tone input at 1GHz	20
Figure 10 0dBm Output Power at 450MHz with APCO C4FM Modulation	21

It is always recommended that you check for the latest product datasheet version from the Datasheets page of the CML website: [www.cmlmicro.com].

1.1 History

Version	Changes	Date
2	<ul style="list-style-type: none">Updated kit enables the evaluation board (PCB571 Rev B) to be fitted with either CMX993 or CMX993W. Documentation and software (ES993020.EXE) updated to reflect this change.Details for operation down to 30MHz, to reflect the current CMX993/CMX993W data sheet.	11/09/09
1	<ul style="list-style-type: none">First Approved	24/11/08

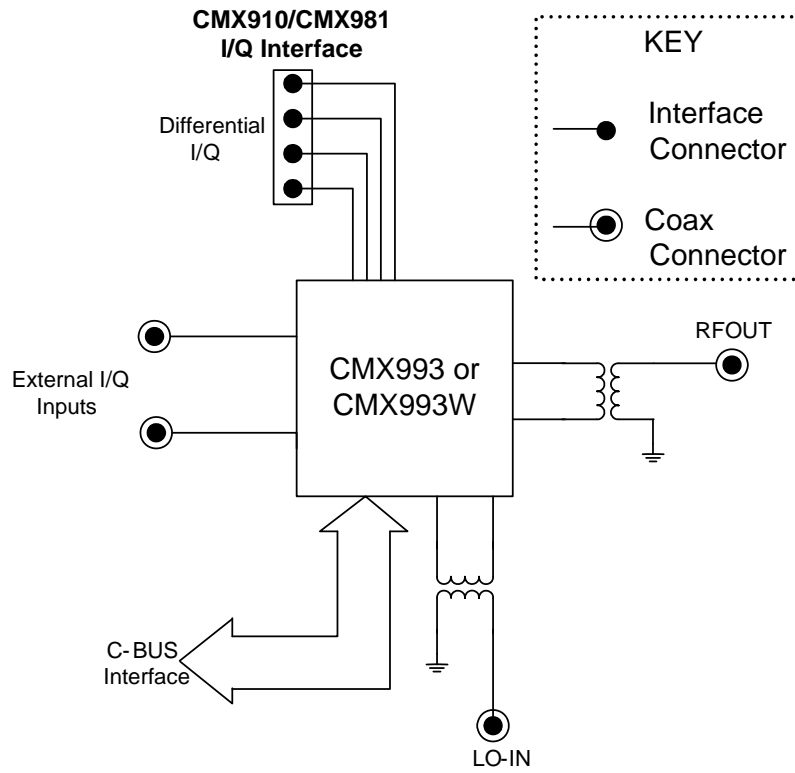

Figure 1 Block Diagram

2 Preliminary Information

The EV9930/EV9930W provides a platform for the evaluation of the CMX993 or the CMX993W. To use the EV9930/EV9930W, a separate microcontroller or PC is required to program the CMX993/CMX993W via its C-BUS interface. This controlling device is not included on the EV9930/EV9930W, but a PE0002 Interface Card (not supplied) will provide the controlling functionality from a PC, via its USB port.

2.1 Laboratory Equipment

The following laboratory equipment is needed to use this evaluation kit:

- Power Supply (Dual Power Supply if using PE0002)
- Spectrum Analyzer (100MHz to 1GHz)
- RF Signal Generator (100MHz to 2GHz)
- I/Q Quadrature Signal Source

For more detailed design or investigation work the customer may require other RF test equipment.

2.1.1 Power Supply

The supply input voltage to the PCB is 5.0V (4.0V to 8.0V acceptable). An on-board regulator is provided to generate the power supplies used on the PCB.

The 5.0V supply should be rated at >200mA.

NOTE: Care should be exercised with the supplies, as they are not protected for reverse polarity.

NOTE: When using the EV9930/EV9930W kit with a PE0002 kit, power is not supplied to the PE0002 via the C-BUS (C-BUS 1) connector (J2). The PE0002 must be connected directly to a separate 5V dc regulated power supply.

2.2 Handling Precautions

Like most evaluation kits, this product is designed for use in office and laboratory environments. The following practices will help ensure its proper operation.

2.2.1 Static Protection

This product uses circuits that can be damaged by electrostatic discharge. Partially damaged circuits can function erroneously, leading to misleading results. Observe ESD precautions at all times when handling this product.

2.2.2 Contents - Unpacking

Please ensure that you have received all of the items on the separate information sheet (EK9930/EK9930W) and notify CML within 7 working days if the delivery is incomplete.

2.3 Approvals

This product is not approved to any EMC or other regulatory standard. Users are advised to observe local statutory requirements, which may apply to this product and the radio frequency signals that may emanate from it.

3 Quick Start

This section provides instructions, in three main steps, for users who wish to experiment immediately with CMX993/CMX993W evaluation. A more complete description of the kit and its use appears later in this document. The EV9930/EV9930W includes a CMX993 or a CMX993W device: both are described in their own, separate, datasheet.

Accordingly, before using the EV9930/EV9930W the user should read the current CMX993/CMX993W datasheet.

3.1 Make External Connections and Apply Power

In this first step external connections are made to the EV9930/EV9930W and then power is applied. Perform the following steps in sequence:

1. Connect test leads as shown in Figure 2.
2. Connect a host μ Controller to C-BUS interface J1 or J2 (alternatively, the CML PE0002 card).
3. Power should be applied to the main supply (5.0V nominal).

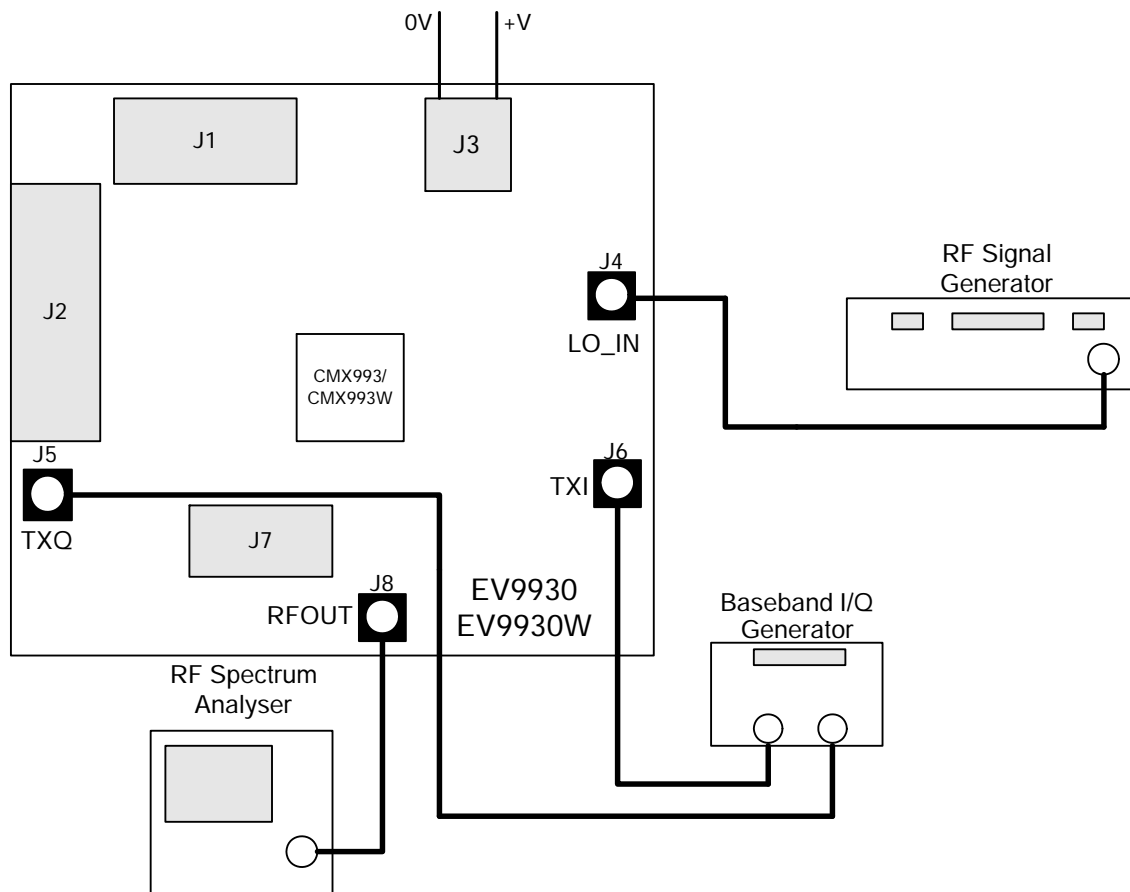

Figure 2 Typical Evaluation Connections for EV9930/EV9930W

3.2 Typical Configure

In this second step the EV9930/EV9930W is configured as follows:

- With a single-ended I/Q baseband input signals at 0V dc bias.
- With an LO signal applied to give an RF output at 450MHz.

Apply signals and set register values as per Table 1. Program the CMX993/CMX993W registers by use of a host μ controller or PE0002 Interface Card, connected as per section 3.1 step 2. The CMX993/CMX993W datasheet gives details of the registers and commands. These can be set directly in the "C-BUS Control" tab of the ES9930xx.EXE software, which forms part of the PE0002 kit.

Signal or Register	Setting	Connector	Note
LO input	900MHz at -10dBm	J4	This frequency is twice the RF output frequency that will be developed
I/Q baseband inputs	0V dc	J5, J6	These inputs must be connected to 0V dc; do not leave them unconnected or open circuit
General Control register (\$02)	Set the CMX993/CMX993W General Control register bits 0 and 1 to their normal operating state (set both to '0') and enable all of: <ul style="list-style-type: none"> • Modulator and LO ccts • Bias circuits • Filter amplifiers • Input amplifiers 		
Forward path gain control register (\$05)	0dB		
Frequency Control register (\$08)	Divide by 2 mode (b4 cleared to '0')		This means the externally applied LO must be twice the desired RF carrier frequency

Table 1 Quick-Start Signal Configuration

3.3 Operate

Baseband I/Q signals (typically 700mV to 1.0V p-p) can now be applied to develop a modulated RF output of ~ 0dBm to +3dBm PEP.

Notes:

- The output of the CMX993/CMX993W's input amplifiers should be 0.35V p-p nominal and 0.5V p-p maximum. Any user changes to the input amplifier's external components and applied baseband I/Q signal levels should ensure the signal applied to the CMX993/CMX993W modulator inputs MODQP / MODQN / MODIP / MODIN remain within the specified range.
- The peak to average power ratio of the user-provided modulation will determine the mean RF output power delivered by the EV9930/EV9930W.

4 Signal Lists

CONNECTOR PINOUT				
Connector Ref.	Connector Pin No.	Signal Name	Signal Type	Description
J1	1 - 10	C-BUS 2 Interface	Logic	Alternative header for C-BUS interface
J2	1 - 20	C-BUS 1 Interface	Logic	C-BUS interface from PE0002 or host / controller PC. See schematics and CMX993/CMX993W datasheet for details.
J3	2	+V	DC	5.0V power supply input
J3	1	0V	DC	Power supply ground
J4	N/A	LO_IN	RF	LO input can be applied at 2 x RF output frequency or 4 x RF output frequency. Nominal input level is -10dBm.
J5	N/A	TXQ	Baseband	Q input signal (non-inverting input of input amplifier)
J6	N/A	TXI	Baseband	I input signal (non-inverting input of input amplifier)
J7	1, 2, 4, 5	TXQ+, TXQ-, TXI-, TXI+	Baseband	Differential I/Q input from the CMX981 evaluation board
J7	3	GND A	Baseband	Connection to analogue ground
J8	N/A	RFOUT	RF	Modulator RF output

Table 2 Signal List

CONNECTOR PINOUT for J1			
Connector Pin No.	Signal Name	Signal Type	Description
1	CSN	I/P	C-BUS enable
2	~	~	Spare pin. Leave unconnected
3	CDATA	I/P	C-BUS data input
4	~	~	Spare pin. Leave unconnected
5	SCLK	I/P	C-BUS clock
6	~	~	Spare pin. Leave unconnected
7	~	~	Spare pin. Leave unconnected
8	~	~	Spare pin. Leave unconnected
9	IRQN	I/P	Interrupt request - if required. Not used
10	GND	Power	Ground

Table 3 C-BUS 2 Interface

CONNECTOR PINOUT for J2			
Connector Pin No.	Signal Name	Signal Type	Description
1	RESETN	I/P	General Reset (reset when pin is low)
2	CSN	I/P	C-BUS enable
3	~	~	Spare pin. Leave unconnected
4	CDATA	I/P	C-BUS data input
5	~	~	Spare pin. Leave unconnected
6	SCLK	I/P	C-BUS clock
7	~	~	Spare pin. Leave unconnected
8	~	~	Spare pin. Leave unconnected
9	~	~	Spare pin. Leave unconnected
10	IRQN	I/P	Interrupt request - if required. Not used
11	GNDD	Power	Connection to digital ground
12	GNDD	Power	Connection to digital ground
13	~	~	Spare pin. Leave unconnected
14	~	~	Spare pin. Leave unconnected
15	~	~	Spare pin. Leave unconnected
16	~	~	Spare pin. Leave unconnected
17	~	~	Spare pin. Leave unconnected
18	~	~	Spare pin. Leave unconnected
19	VDDIO	Power	Digital power supply – if required. Not used.
20	VDDIO	Power	Digital power supply – if required. Not used.

Table 4 C-BUS 1 Interface (for PE0002)

TEST LOOPS		
Test Loop Ref.	Default Measurement	Description
TL1	0V	GND – Analogue ground probe point
TL2	N/A	IRQN (not used)
TL3	0V	GNDD – Digital ground probe point
TL4	1.6V dc	BVREF buffered Vref
TL5	1.6V dc	993 - I input amplifier output, 993W - I channel bias op-amp output
TL6	1.6V dc	993 - Q input amplifier output, 993W - Q channel bias op-amp output

Table 5 Test Loops

TEST POINTS		
Test Point Ref.	Default Measurement	Description
TP1	3.3V dc	Filtered 3.3V regulator output for digital circuits
TP2	3.3V dc	3.3V regulator output for analogue circuits
TP3	N/A	Alternative bias input Q channel
TP4	N/A	Alternative bias input I channel
TP5	1.6V dc	993 - I channel bias op-amp output, 993W – I Channel Wideband Input amp output
TP6	1.6V dc	993 - Q channel bias op-amp output, 993W – Q Channel Wideband Input amp output

Table 6 Test Points

Notes:

I/P	=	Input
O/P	=	Output
BI	=	Bidirectional
TL	=	Test Loop
TP	=	Test Point

5 Circuit Schematics and Board Layouts

For clarity, circuit schematics are available as separate high-resolution files. These can be obtained via the CML website.

The layout on each side of the pcb is shown in Figure 3 and Figure 4.

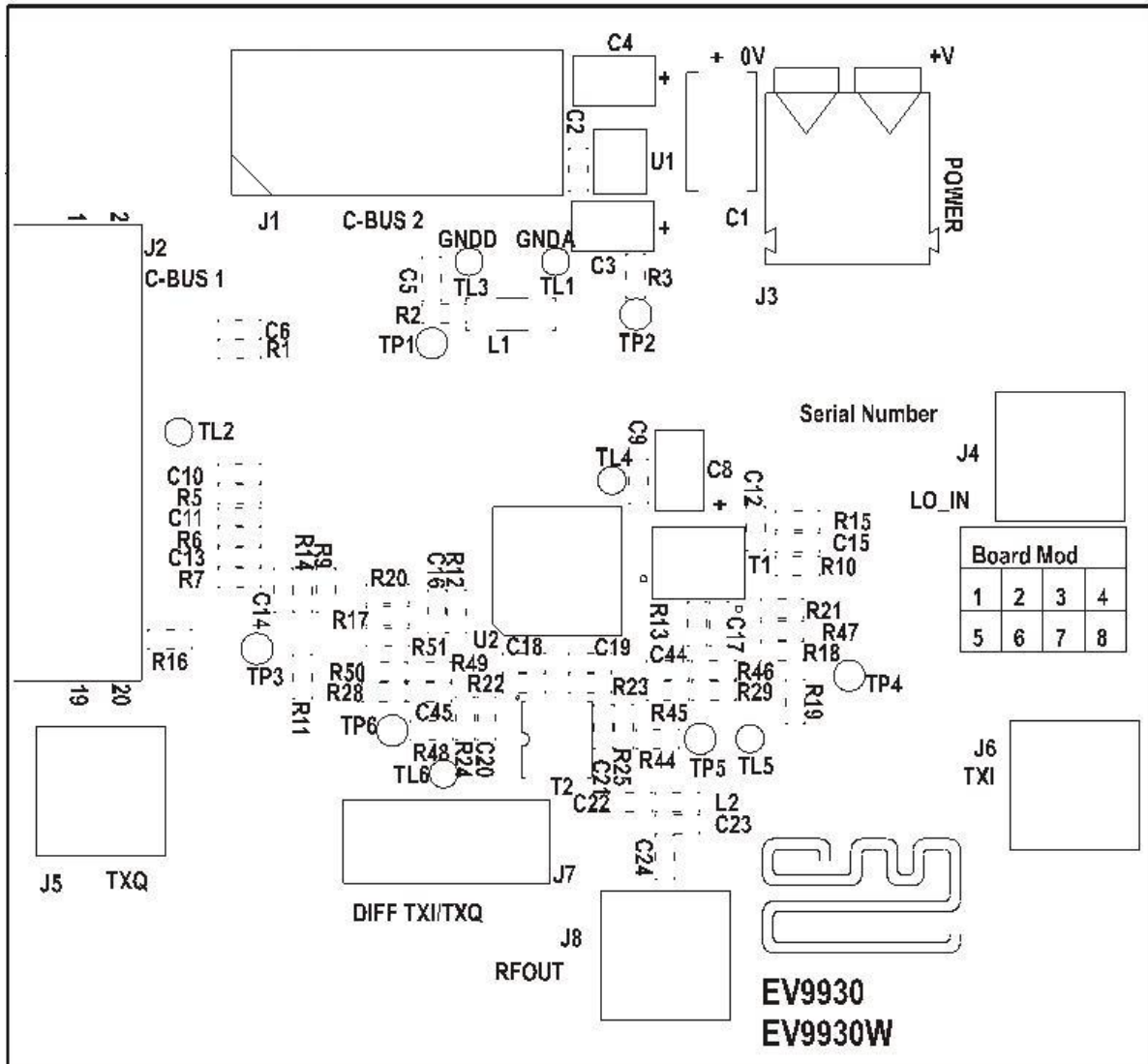

Figure 3 PCB Layout: top

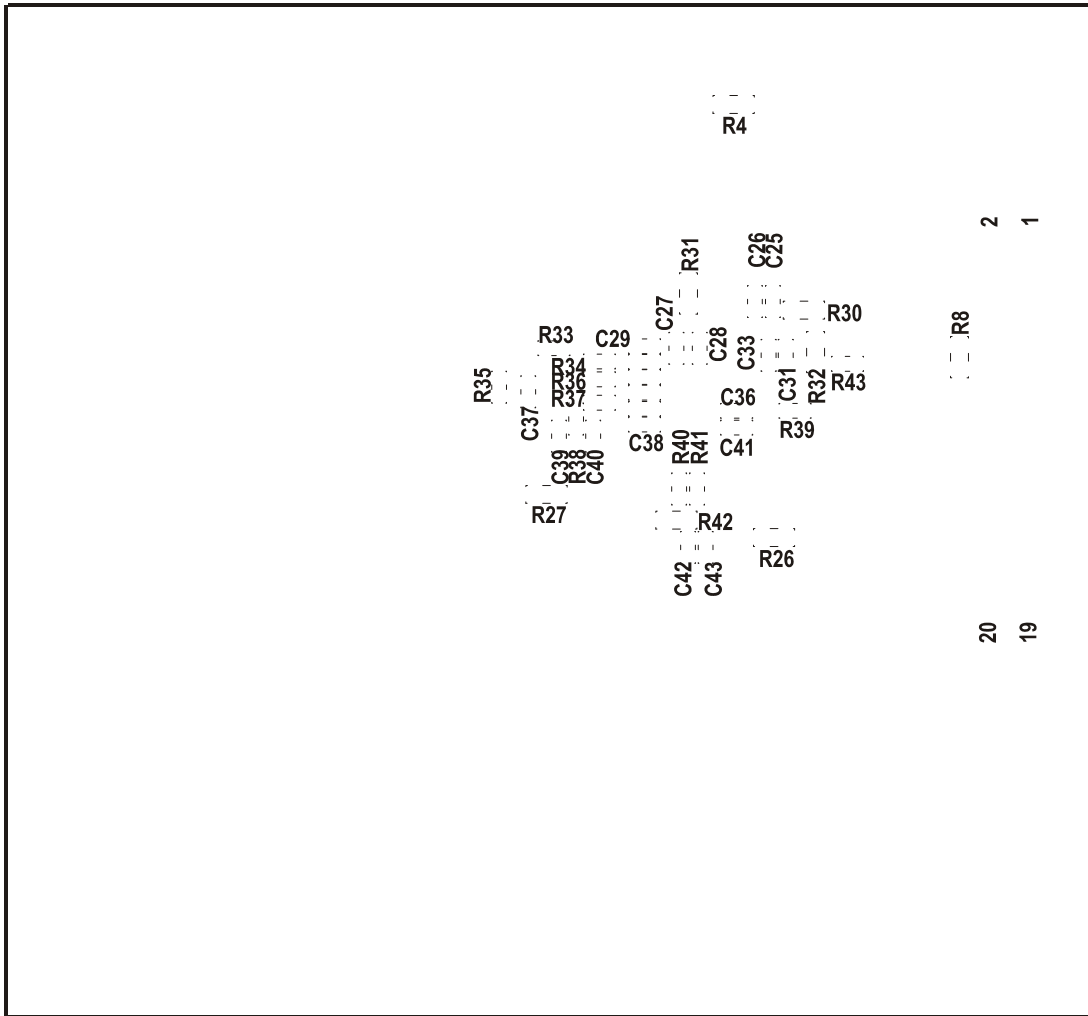

Figure 4 PCB Layout: bottom

6 Detailed Description

The CMX993/CMX993W datasheet (available at www.cmlmicro.com) should be referred to for a detailed description of the CMX993/CMX993W device.

The EV9930/EV9930W functionality includes:

- Demonstration of the I/Q Modulator
- Operation at 30MHz to 1GHz
- C-BUS Interface that allows the card to be connected to a host μ Controller. Interface to a PC for initial test and customer evaluation is available separately with the PE0002, which allows control of all device functions from a PC via the software available on the CML website.
- Direct Interface to CMX910/CMX981 evaluation cards, which allows demonstration of:
 - GFSK, GMSK or $\pi/4$ -DQPSK modulation
 - Burst and continuous transmission

In summary, the EV9930 allows the user to create experiments to investigate all aspects of the CMX993. The EV9930W is similar, but is fitted with the wider filter bandwidth CMX993W device. The EV9930/EV9930W is designed to allow user modification, to support the detailed investigation of each user's application.

6.1 Hardware Description

6.1.1 Quadrature (I/Q) Modulator

This Evaluation Kit is configured to allow the CMX993 or the CMX993W Quadrature Modulator to operate with single-ended external inputs. The gains are set in the baseband amplifier sections to suit the input drive levels in section 6.1.3. The LO input and modulator output are matched with broadband balun transformers to allow wideband operation from 200MHz to 1GHz.

NOTE: The EV9930/EV9930W is supplied with transformer (T2) fitted with a TC4-14+ from Mini Circuits; this is recommended for applications between 200MHz and 1GHz. For operation at 30MHz to 200MHz customers are recommended to fit an alternative component e.g. Coilcraft WBC4-1WL.

A simplified output configuration is detailed in the CML Application Note - 'CMX993: Simplified RF Output Match', which is available from www.cmlmicro.com.

The RESETN pin is pulled high with 100k ohms. The user can pull this pin low to reset the device (or the software reset can be used).

6.1.2 Local Oscillator (LO)

A local oscillator has not been provided on the EV9930/EV9930W. A connector is provided to allow an external oscillator source to be injected at twice or four times the RF output frequency depending on the oscillator mode selected in the CMX993/CMX993W frequency control register.

6.1.3 I/Q Baseband Inputs

The board allows the quadrature (I/Q) inputs to come from the CMX981 or from an alternative external source. The input can be differential or single ended. Adjusting the values around the CMX993/CMX993W input amplifiers creates the required input configuration. The default setup is for single ended inputs, which are applied to TXI and TXQ. A typical input signal level would be in the region of 700mV to 1.0V p-p at 0V dc bias.

6.1.4 Differential I/Q Interface

The EV9930/EV9930W has an interface to allow connection to the EV9100 (CMX910) or EV9810 (CMX981) evaluation cards. The connector J7 allows differential I/Q signals to be applied directly from these boards. When J7 is used it is necessary to remove R26, R28/R48, R29/R44 and R27.

6.1.5 Power Supply

The input to the PCB for the CMX993/CMX993W and the interface circuits is nominally 5.0V (4.0V to 8.0V is acceptable). An on-board regulator generates the 3.3V power supply used on the EV9930/EV9930W.

6.2 Software Description

The EV9930/EV9930W does not require any embedded firmware. The PE0002 Interface Card, available separately from CML, and the related software file (ES9930xx.ZIP) can be used to control the EV9930/EV9930W. To use the software connect the EV9930/EV9930W to a PE0002 using the connector J2, labelled C-BUS 1. First ensure the drivers supplied for the PE0002 are installed correctly on the user's host PC. Run the ES9930xx.exe and the main application window will open with a progress bar for the initialisation process. Once the initialisation process is complete, one of two tabs can be selected.

To select a tab simply click on the corresponding name in the row at the top of the program window. Setting or clearing the check box associated with a bit of a register will cause that bit to be set or cleared when the register is next written to. If the 'Auto Write' check box is set, a register will be written to whenever a check box, or list box associated with it, is modified. This removes the need to click the 'Write' button associated with that register. The program can be closed at any time by clicking the 'Close' button or by pressing 'Alt' and 'F4' keys simultaneously.

6.2.1 The 'CMX993(W) Regs (\$02 - \$08)' Tab

This tab allows all registers of the CMX993 to be controlled and a general or hardware reset to be performed. Also on this tab the PE0002 CBUS header 1 and 2 can be selected.

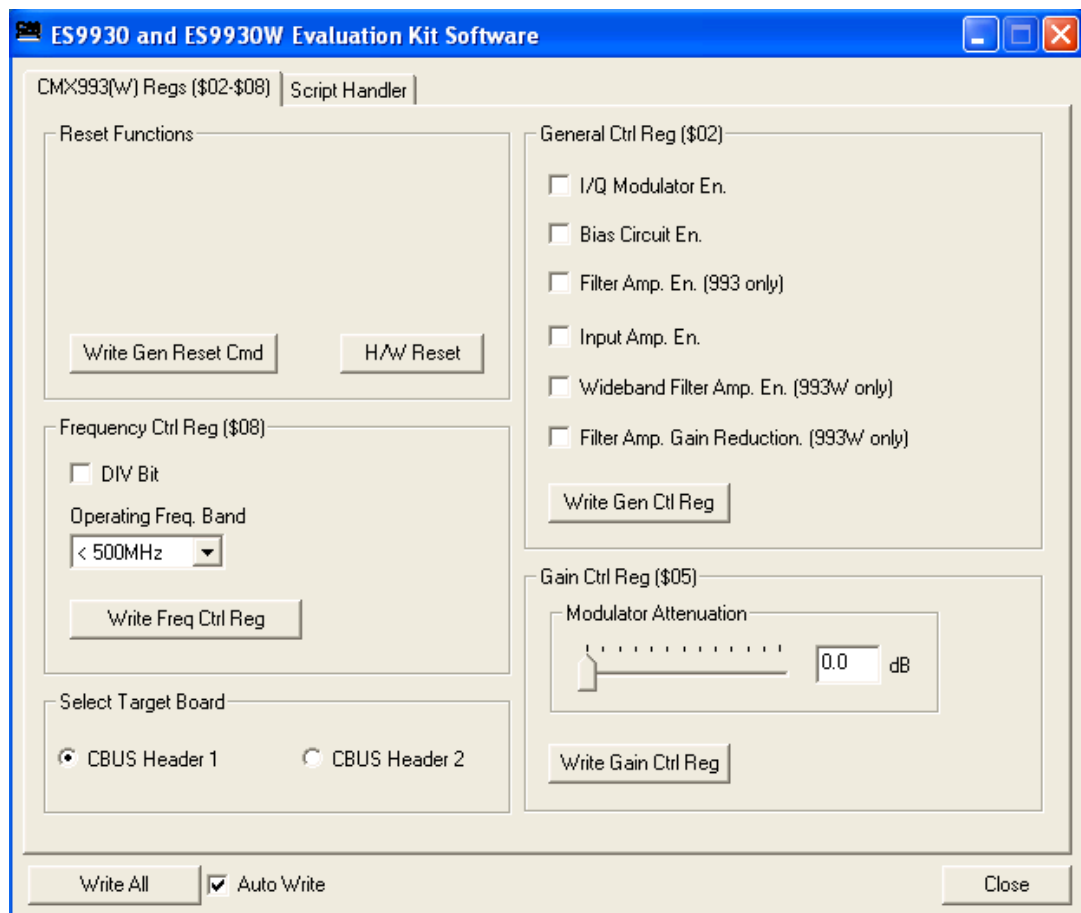

Figure 5 The 'CMX993(W) Regs (\$02 - \$08)' Tab

6.2.2 The Script Handler Tab

The Script Handler tab (shown in Figure 6) allows the execution of script files consisting of register write, read, and delay commands. These are plain text files on the PC, which are compiled via the GUI but executed by the E2 Microprocessor on the PE0002 board. The script language is documented separately in the “Script Language Reference” document, which can be downloaded with the PE0002 support package from the CML website. Control of the EV9930/EV9930W does not currently require the use of script files.

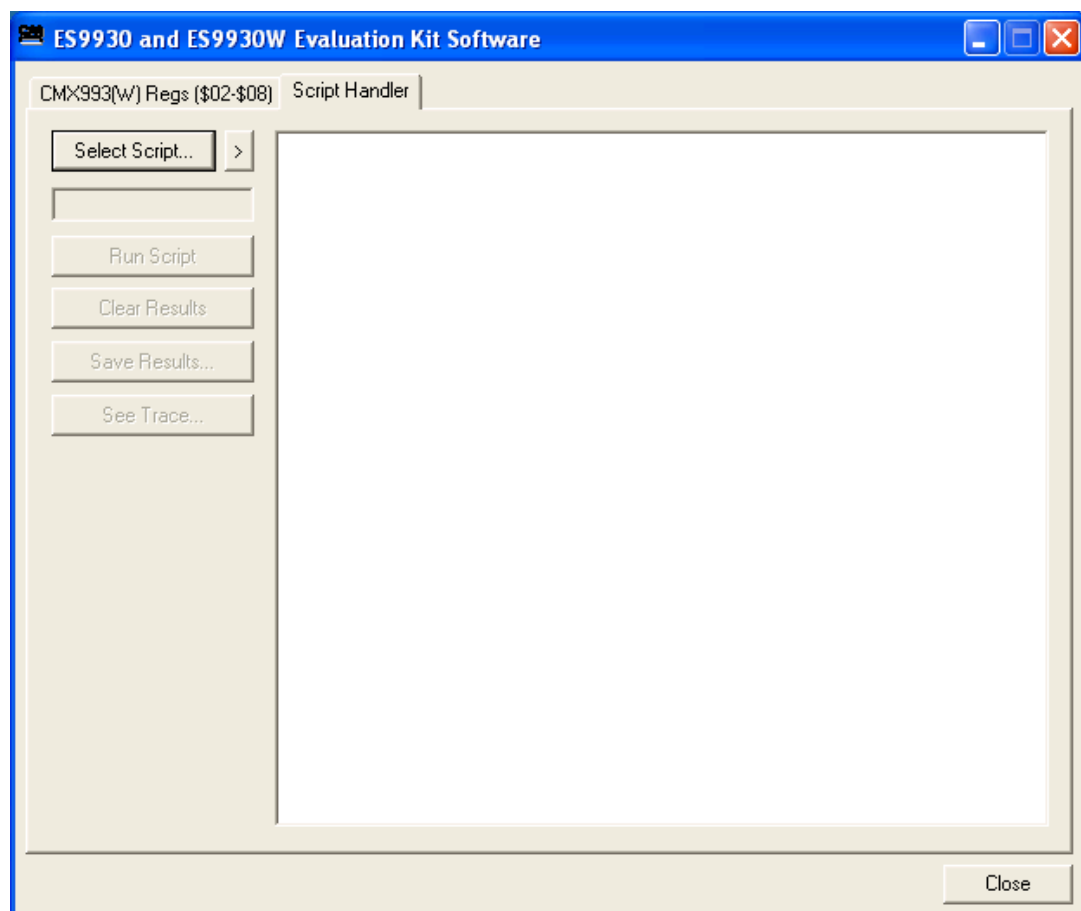

Figure 6 The ‘Script Handler’ Tab

To select a script file, click on the ‘Select Script’ button. The Open File Dialog is displayed. Browse and select the script file. The folder that contains the script file will be the working folder of the script (i.e. all the files referenced in the script will be searched in this folder). Alternatively, select a script file from the recent files list. Click on the ‘>’ button to display the list.

The results window displays the values returned by the script. These results can be saved to a text file or discarded by clicking on the ‘Save Results’ or ‘Clear Results’ buttons, respectively. When a script file is being executed the ‘Run Script’ button will change to be the ‘Abort’ button, the rest of the tab will be disabled and the other tabs cannot be selected.

After a script has finished running and when trace data is available, the ‘See Trace...’ button will be enabled. Up to 131072 C-BUS transactions can be logged in the PE0002 board. Click in the ‘See Trace...’ button to display the Trace dialog box. Note that the C-BUS transactions are only logged if the feature has been enabled in the script. For further details, see the “Script Language Reference” document, which can be downloaded with the PE0002 support package from the CML website.

6.3 Application Information

6.3.1 Typical Performance

All results have been taken with an LO level of -10dBm and with the modulator driven from the input amplifiers. The filter amplifiers have been used to buffer BVREF to drive the other modulator inputs (see the CMX993/CMX993W datasheet for a typical application circuit).

The plot in Figure 7 shows the typical image rejection and carrier leakage seen at 450MHz at an output power level of 0dBm . The plot in Figure 8 shows the intermodulation (IMD) performance at 450MHz with a two-tone input. The output level is $+3\text{dBm}$ PEP and the plot in Figure 9 shows the IMD performance at 1GHz with the same output power. The plot in Figure 10 shows the ACP performance at 450MHz with APCO C4FM modulation: the measurement is 'non-spurious adjacent channel power ratio' (TIA/EIA 102.CAAB-B), requirement = 67dBc , typical performance = 70dBc . Typical input drive level at the modulator, for 0dBm output level at 450MHz , is $\sim 350\text{mVp-p}$ (note the input amplifiers on the EV9930 have a gain of ~ 0.5).

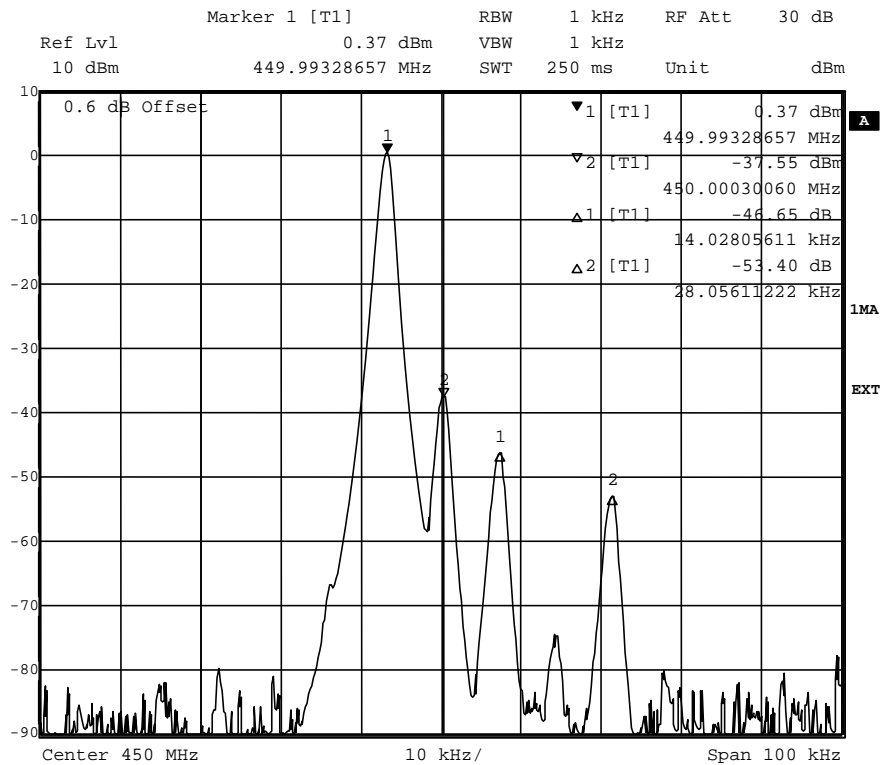

Figure 7 0dBm Output Level at 450MHz with a single tone input

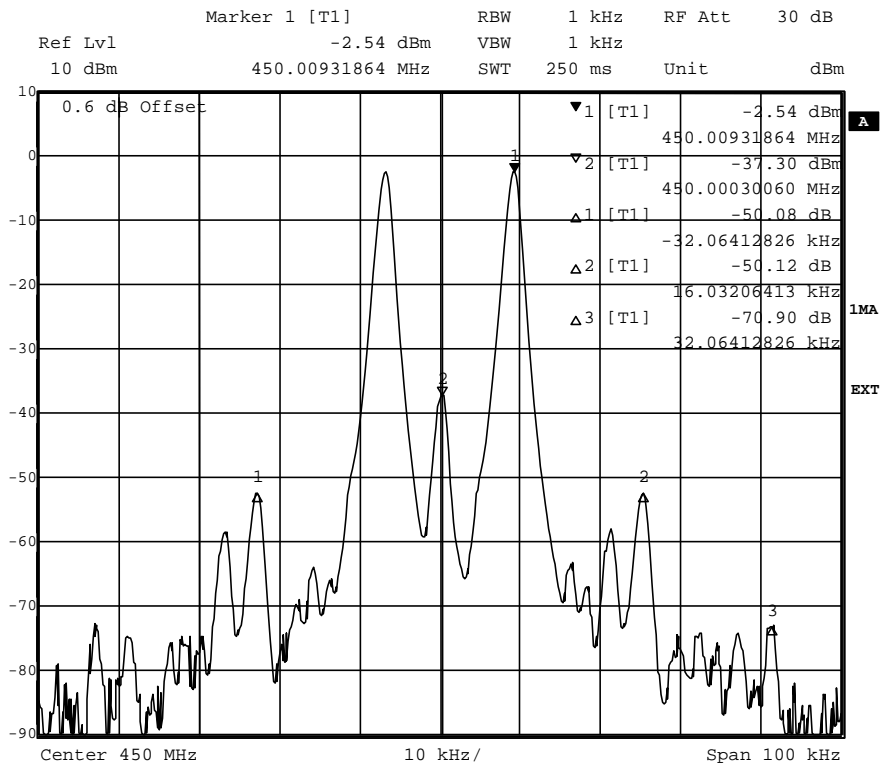

Figure 8 +3dBm PEP Output, two-tone input at 450MHz

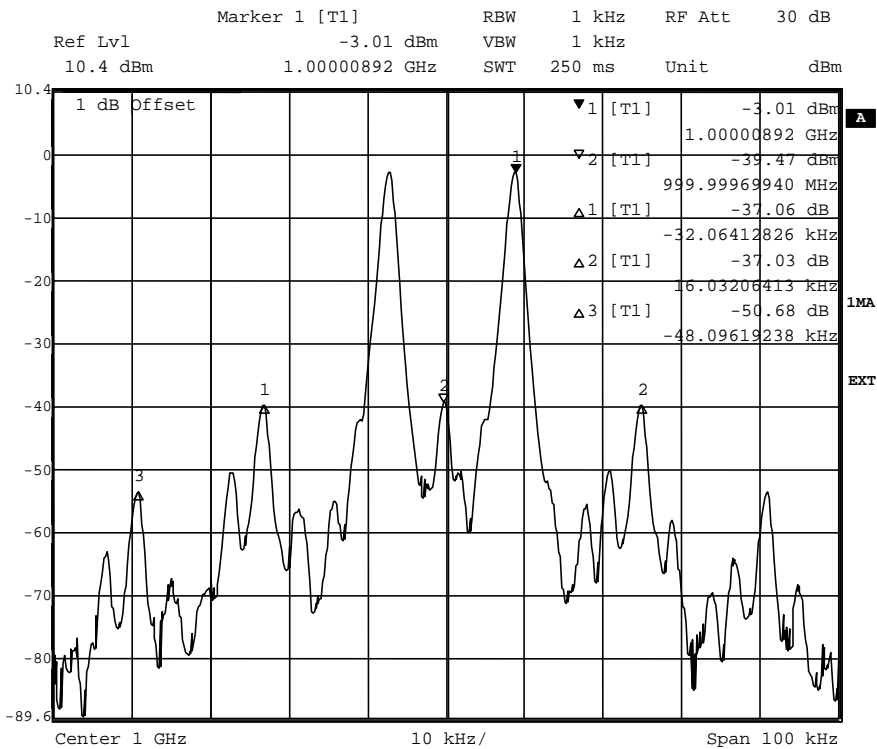

Figure 9 +3dBm PEP Output, two-tone input at 1GHz

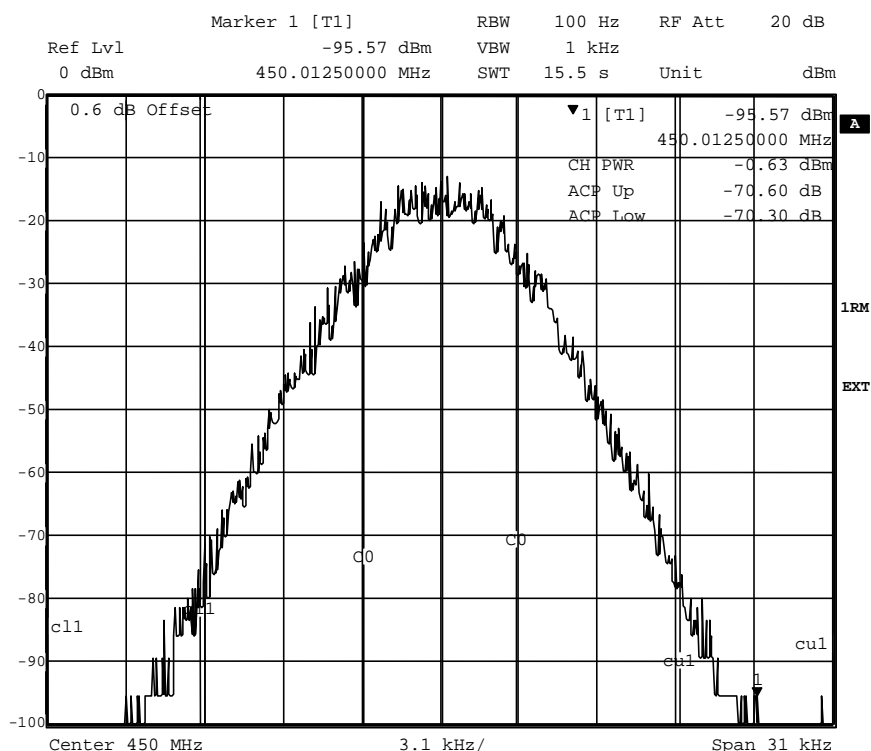

Figure 10 0dBm Output Power at 450MHz with APCO C4FM Modulation

6.4 Troubleshooting

The CMX993/CMX993W/EV9930/EV9930W is a complex RF system. If incorrectly programmed or modified, results will be at variance from datasheet performance. Please study the IC datasheet, this manual and the associated schematics and layout drawings carefully when troubleshooting.

This section provides some suggestions to help users resolve application issues they might encounter.

Error Observed	Possible Cause	Remedy
No RF Output	I/Q signals not applied LO signal not applied	Try re-enabling circuitry in CMX993/CMX993W or measure I/Q signal at TL5/6 Check LO signal is present at sufficient drive level
Discrete spurious present on transmission at 18kHz offset from carrier causing degrading adjacent channel power when using EV9810 to generate modulation	Insufficient isolation between EV9930/EV9930W and EV9810 power supplies	Ensure sufficient de-coupling between power supplies or use separate bench power supplies for EV9810 and EV9930/EV9930W

Table 7 Possible Errors

7 Performance Specification

7.1 Electrical Performance

7.1.1 Absolute Maximum Ratings

Exceeding these maximum ratings can result in damage to the Evaluation Kit.

	Min.	Max.	Units
Supply Voltage ($V_{IN} - V_{SS}$)	0	8.0	V
Current into or out of V_{IN} , and V_{SS} pins	0	+2.0	A
Current into or out of any other connector pin	-20	+20	mA

7.1.2 Operating Limits

Correct operation of the Evaluation Kit outside these limits is not implied.

	Notes	Min.	Max.	Units
Supply Voltage ($V_{IN} - V_{SS}$)		4.0	8.0	V

Notes:

7.1.3 Operating Characteristics

For the following conditions unless otherwise specified:



$$V_{IN} - V_{SS} = 7.2V, T_{amb} = +25^{\circ}C.$$

	Notes	Min.	Typ.	Max.	Units
DC Parameters (Excluding PA Supply)					
I _{DD} (CMX993/CMX993W Power saved)	1, 2	–	–	1	mA
I _{DD} (All CMX993/EV9930 Circuitry Enabled)	1	–	103	–	mA
I _{DD} (All CMX993W/EV9930W Circuitry Enabled)	2	–	104	–	mA
AC Parameters					
Up-Converter Output					
Output Power		–	0	–	dBm
Attenuator Range		–	0 to 30	–	dB
Attenuator Step Size		–	2.5	–	dB
I/Q Input Signal					
Amplitude	3	–	0.7 to 1.0	–	Vp-p
dc Level	3	–	0	–	V
LO Input					
Input Impedance		–	50	–	Ω
Frequency Range		–	60 to 2000	–	MHz
Input Level		–	-15 to -10	–	dBm
C-BUS Interface					
See CMX993/CMX993W Datasheet					

Notes:

1. EV9930 PCB current consumption, not just the CMX993 current consumption.
2. EV9930W PCB current consumption, not just the CMX993W current consumption.
3. At J5/J6 with default configuration.

CML does not assume any responsibility for the use of any circuitry described. No IPR or circuit patent licences are implied. CML reserves the right at any time without notice to change the said circuitry and any part of this product specification. Evaluation kits and demonstration boards are supplied for the sole purpose of demonstrating the operation of CML products and are supplied without warranty. They are intended for use in a laboratory environment only and are not for re-sale, end-use or incorporation into other equipments. Operation of these kits and boards outside a laboratory environment is not permitted within the European Community. All software/firmware is supplied "as is" and is without warranty. It forms part of the product supplied and is licensed for use only with this product, for the purpose of demonstrating the operation of CML products. Whilst all reasonable efforts are made to ensure that software/firmware contained in this product is virus free, CML accepts no responsibility whatsoever for any contamination which results from using this product and the onus for checking that the software/firmware is virus free is placed on the purchaser of this evaluation kit or development board.

 CML Microcircuits (UK) Ltd COMMUNICATION SEMICONDUCTORS	 CML Microcircuits (USA) Inc. COMMUNICATION SEMICONDUCTORS	 CML Microcircuits (Singapore)PteLtd COMMUNICATION SEMICONDUCTORS <div style="display: flex; justify-content: space-around;">SingaporeChina</div>	
Tel: +44 (0)1621 875500 Fax: +44 (0)1621 875600 Sales: sales@cmlmicro.com Tech Support: techsupport@cmlmicro.com	Tel: +1 336 744 5050 800 638 5577 Fax: +1 336 744 5054 Sales: us.sales@cmlmicro.com Tech Support: us.techsupport@cmlmicro.com	Tel: +65 67450426 Fax: +65 67452917 Sales: sg.sales@cmlmicro.com Tech Support: sg.techsupport@cmlmicro.com	Tel: +86 21 6317 4107 +86 21 6317 8916 Fax: +86 21 6317 0243 Sales: cn.sales@cmlmicro.com.cn Tech Support: sg.techsupport@cmlmicro.com
- www.cmlmicro.com -			