

## ALC80C823FP040

Aliases (A547JW823M040C)

ALC80, Aluminum Electrolytic, 82,000 uF, 20%, 40 VDC, -40/+105°C

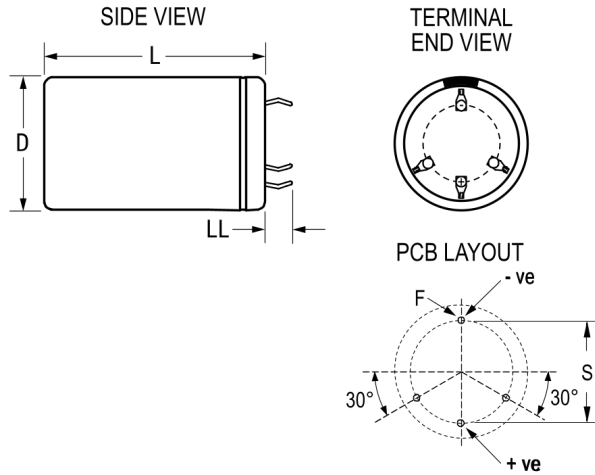

Click [here](#) for the 3D model.

### Dimensions

D	45mm +1mm
L	105mm +/-2mm
S	22.5mm +/-0.1mm
LL	6.3mm +/-1mm
F	2mm +/-0.1mm

### Packaging Specifications

Sleeving	Yes
Packaging	Bulk, Bag

### General Information

Series	ALC80
Dielectric	Aluminum Electrolytic
Description	Snap-In, Aluminum Electrolytic
RoHS	Yes
Lead	4 Pin
AEC-Q200	No
Halogen Free	Yes
Component Weight	225 g
Notes	Dimensions D And L Include Sleeving.
Shelf Life	156 Weeks

### Specifications

Capacitance	82,000 uF
Capacitance Tolerance	20%
Voltage DC	40 VDC, 46 VDC (Surge)
Temperature Range	-40/+105°C
Rated Temperature	105°C
Life	9000 Hrs (Rated Voltage and Ripple Current at 105C), 14000 Hrs (Rated Voltage at 105C)
Resistance	9.944 mOhms (100Hz 20C), 8.695 mOhms (10kHz 20C)
Ripple Current	18.33 Amps (100Hz 105C), 20.56 Amps (10kHz 105C)
Leakage Current	6000 uA (5min 20°C)