

Clamp 42-115mm 738546

Description

Mounting Hardware for Special Communication Antennas:
Clamps
(Wind Load Category "L", "M" and "H")

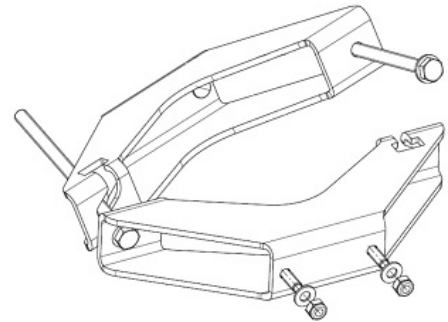

Technical Data

Mechanical Data

See table below

Environmental Data

Wind Load Category "L", "M" and "H"

Related Documents

Security instruction

DOC-0000278984

Clamps

Type No.	731651	738546	85010002	85010003
Suitable for mast diameter	28-60 mm	42-115 mm	110-220 mm	210-380 mm
Antenna - mast distance F	25-28 mm	20-26 mm	47-55 mm	48-68 mm
Number of pieces	1 clamp	1 clamp	1 clamp	1 clamp
Material - Clamp	Hot-dip galvanized steel	Hot-dip galvanized steel	Hot-dip galvanized steel	Hot-dip galvanized steel
- Screws	Hot-dip galvanized steel/ Stainless steel	Hot-dip galvanized steel/ Stainless steel	Hot-dip galvanized steel/ Stainless steel	Stainless steel/ Stainless steel
- Nuts	Stainless steel	Stainless steel	Stainless steel	Stainless steel
Weight	0.8 kg	1.1 kg	2.7 kg	4.8 kg

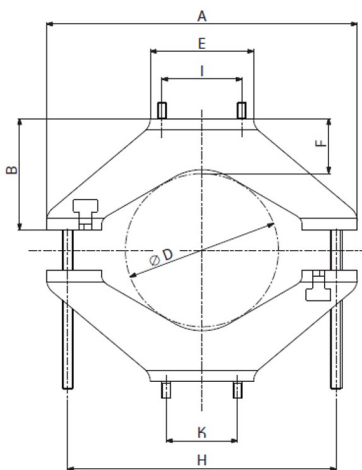
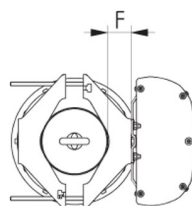
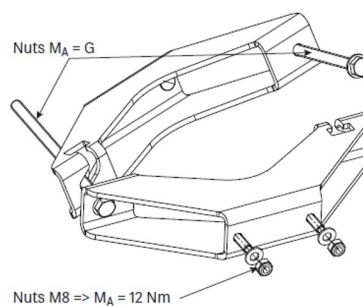
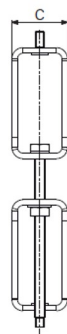

Figure similar to 85010002



Type No.	A	B	C	D	E	F	G	H	I	K
731651	116 mm	40 mm	40 mm	28-60 mm	93 mm	25-28 mm	20 Nm	84 mm	-	64 mm
738546	152 mm	40 mm	40 mm	4-115 mm	93 mm	20-26 mm	25 Nm	125 mm	72 mm	64 mm
85010002	280 mm	100 mm	50 mm	110-220 mm	93 mm	47-55 mm	35 Nm	240 mm	72 mm	64 mm
85010003	442 mm	150 mm	50 mm	210-380 mm	150 mm	48-68 mm	35 Nm	392 mm	72 mm	64 mm

Data Sheet

HUBER+SUHNER

**Clamp 42-115mm
738546**