

Digi-Pas®

Innovation & Technology Driven™

USER MANUAL

2-AXIS

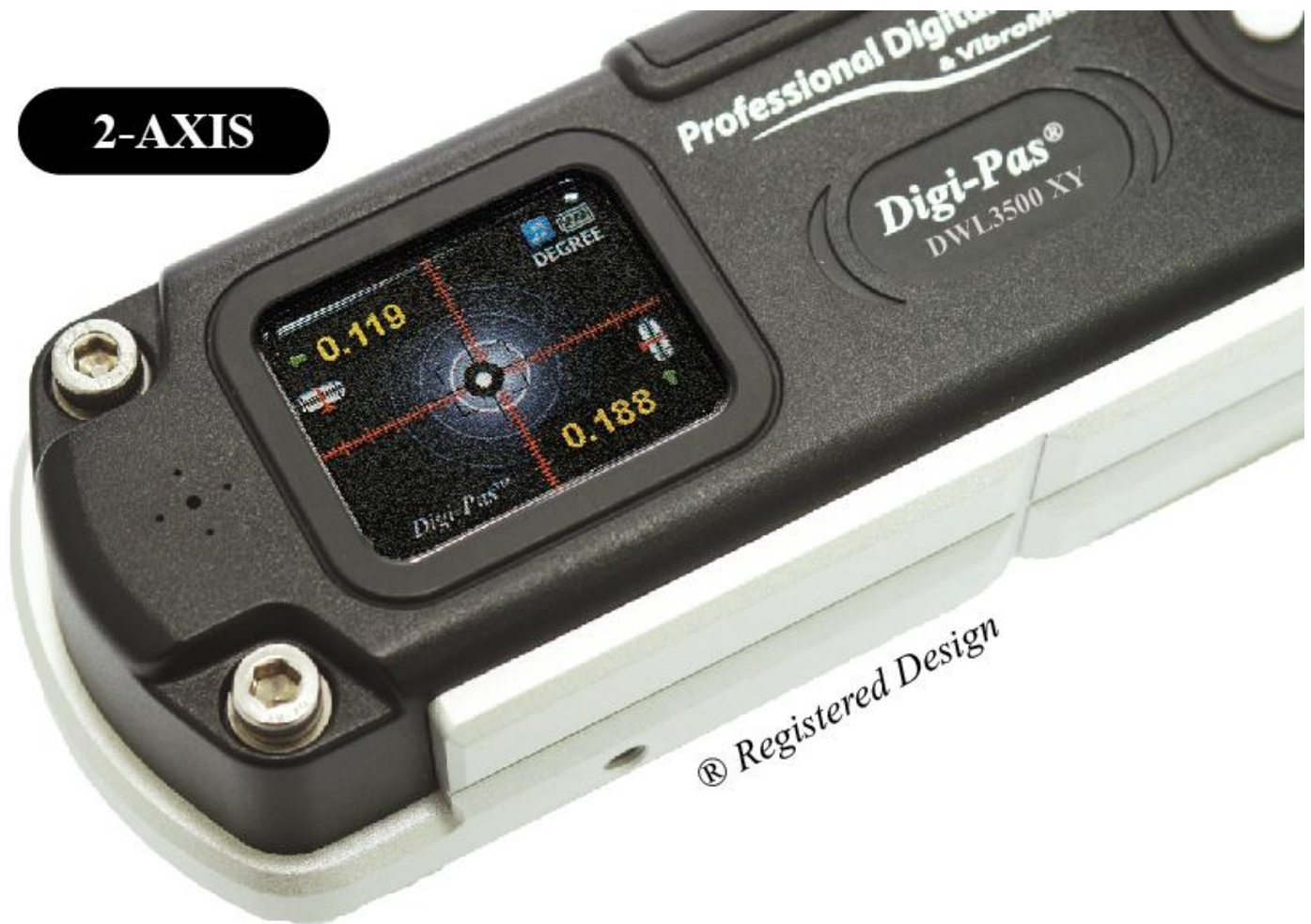

2-Axis High Precision Digital Machinist Level Model: DWL3500XY

www.digipas.com

REVISION 6.10

Note: Contents in this instruction manual is continuously updated, please check Digi-Pas website for latest version.

INTELLECTUAL PROPERTY

This manual contains propriety information, which is protected by copyrights. All rights are reserved. No part of this manual may be photocopied, reproduced, redistributed or translated to another language without prior written consent of JSB TECH Company.

The information in this manual was correct at the time of printing, stored in CD or uploaded in the Company website. However, JSB TECH will continue to improve products and reserves the rights to change specification and maintenance procedures at any time without prior notice.

Digi-Pas® Products were manufactured under ISO9001 & ISO14001 standards, tested to comply by the followings certification bodies:



CONTENTS

CHAPTER 1: DEVICE OVERVIEW

- Technical Specification
- Overview
- List of Items

CHAPTER 2: SETTING UP

- Operating Procedure
- Mounting Device on Fixture

CHAPTER 3: USER INTERFACE

- Single Axis Mode Interface
- Dual Axis Mode Interface
- Main Menu Icon Functions

CHAPTER 4: FEATURES AND SETTING

- Absolute Level
- Alternate Zero
- Sync Menu
- Angle Meter
- Vibro Meter
- Setting Menu

CHAPTER 5: STORAGE AND CLEANING

CHAPTER 6: WARRANTY

APPENDIX: USER CALIBRATION

CHAPTER 1: DEVICE OVERVIEW

Technical Specification

DWL3500XY

Measurement Range (Single Axis Mode)	0.000° to ± 20.000°
Measurement Range (2-Axis Mode)	0.000° to ± 10.000°
Resolution	0.001° (≤20µm/M) (0.0002 in/ft)
Accuracy	± 0.001° at 0.000° ~ ± 2.000° (≤20µm/M) (0.0002 in/ft) (3.6 arcsec.) ± 0.003° at other angle
Repeatability	0.001° (≤20µm/M) (0.0002 in/ft)
Cross Axis Error	Negligible (± 0.00025°)
Vibrometer (Relative g)	2.0
Display	Colour TFT LCD
Power Supply *	4 x AAA 1.5V Batteries / USB
Material	PC ABS / Cast Iron
Connectivity	USB 2.0 Cable (≤ 5 metre) Bluetooth (≤30 metre) (Optional)
PC SYNC Software	Basic Edition Professional Edition (Optional)
Operating Temperature	-10°C to +50°C (Calibrated) 14°F to 122°F (Calibrated)
Dimension (mm)	188 x 62 x 37
Nett Weight (Approx.)	1100 gram
User Self Calibration	Yes

Specifications are subject to change without notice.

*Alternative Device power can be obtained from External USB Power Source.

Note:

Product performance to specification are comply with accredited Calibration & Test Providers in USA, Japan, UK and Germany to conform with **NIST, JIS, UKAS & DIN** under the International Laboratory Accreditation Cooperation (**ILAC**) and American Association for Laboratory Accreditation (**A2LA**). For more information, please visit “www.digipas.com”.

Device Overview

Battery Compartment of 4 x "AAA" size 1.5V batteries.
-Observe the polarity of the batteries indicated on the top of the battery cover

LCD Colour graphic digital display

USB Port:
- USB power supply
- PC Synchronization
- Firmware update

ON/OFF: Power On/Off
- Escape from Mode function

CAL: Activate calibration mode

HOLD: Freeze display value
- Scroll right

MODE: Change the function and display mode
- Selection the function

Buzzer sound alert

UNIT: Change the unit (° (degree), mm/M, In/FT)
of the measurement
- Scroll left

FRONT VIEW

Side Screw holes: For mounting purpose

Ball Screw: Using of Three - points screw
on measuring plane surface

Cast Iron Base

BACK VIEW

List of Items

i. List of items included in DWL-3500XY product package

Item No.	Description	Quantity
1.	DWL 3500XY High Precision Digital Level with Vibrometer	1 unit
2.	Certificate of Calibration	1 set
3.	AAA batteries	4 pcs
4.	USB 2.0 cable (3 Meters)	1 pc
5.	Basic PC Sync Software	1 pc
6.	M5 Button head screws	3 pcs

ii. List of items included in DWL-35000XY (Bluetooth version) product package

Item No.	Description	Quantity
1.	DWL 3500XY High Precision Digital Level with Vibrometer (Bluetooth version)	1 unit
2.	Certificate of Calibration	1 set
3.	AAA batteries	4 pcs
4.	USB 2.0 cable (3 Meters)	1 pc
5.	Basic PC Sync Software	1 pc
6.	M5 Button head screws	3 pcs



CHAPTER 2: SETTING UP

Operation Procedure

1. Insert 4 pieces of "AAA" batteries into the battery compartment and press ON/OFF button. Alternatively, insert USB power source to the USB Port to power up the device. Take note that the device performance might be affected when poorly regulated USB power source is used.

Battery: 4 x "AAA" size 1.5V batteries

(Take note on the battery's polarity as indicated on top of the battery cover)

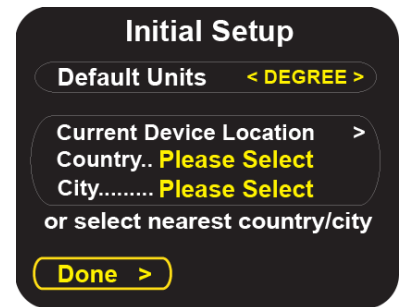
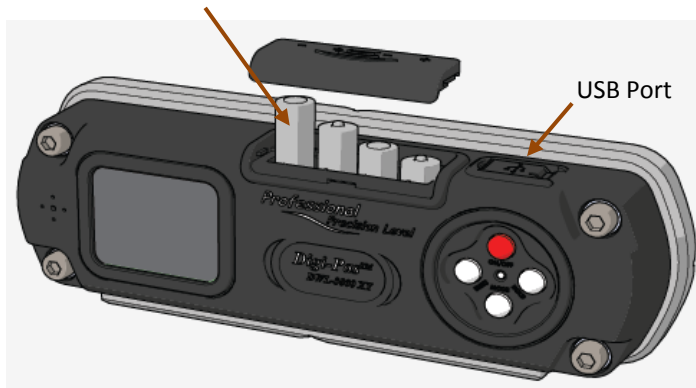

2. Initial Setup screen pops up. Press ON/OFF button to scroll up or MODE button to scroll down for selecting "Default Units" or "Current Device Location". Press "UNITS" or "HOLD" button to input the selected option. Select the nearest option when your location is not available in the default list. Scroll to select "Done" to continue.
3. Allow sufficient time for device to warm up and stabilise after turning on the device. The device is ready to use.

Note: For maximum accuracy, perform calibration (refer to APPENDIX: User Calibration) or Absolute Level (refer to Chapter 4: Absolute Level for more details) before measurement.

Mounting Device On Fixture or Work Piece

The two threaded holes are provided for mounting the device onto user-defined fixtures/machinery.



User defined fixture/machinery

To mount the device onto user's defined fixture or work piece. Remove both the set screw (M5), then replace with appropriate type of screws specified by user.

CHAPTER 3: USER INTERFACE

Single Axis Mode Interface



Single Axis Mode Display Screen and Button Function

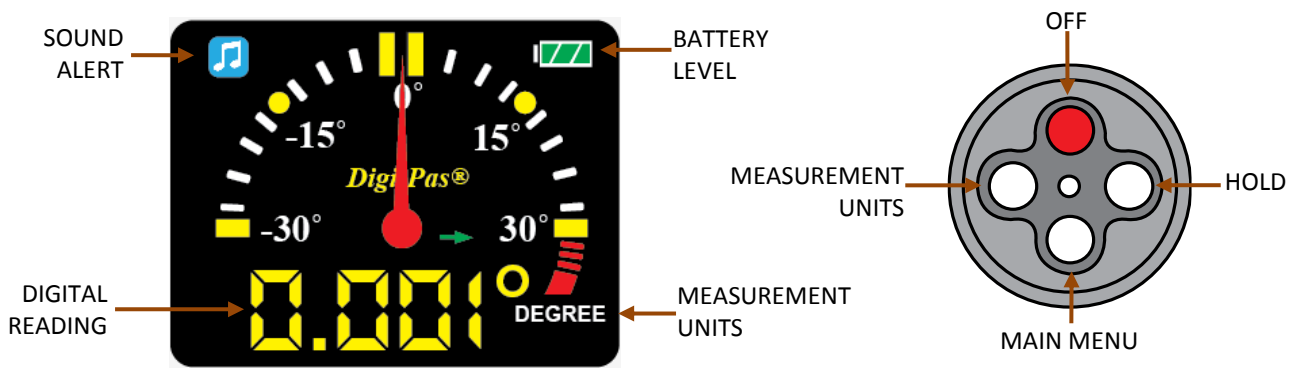

Single Axis Mode Operation

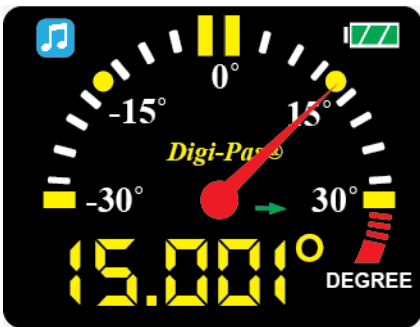

Place the digital level on the surface to be measured.



Please ensure the contact surfaces of the device and measuring plane are clean and free from dust particles.



The green arrow sign on display indicates the higher side.

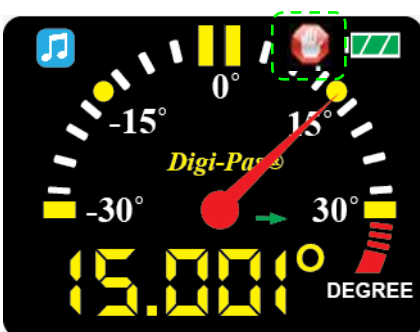

User may “freeze” the screen by pressing the HOLD button.



The icon pops up to indicate the screen is paused. To resume operation, press the hold button once.

Dual-Axis Mode Interface



Dual-Axis Mode Display Screen and Button Function

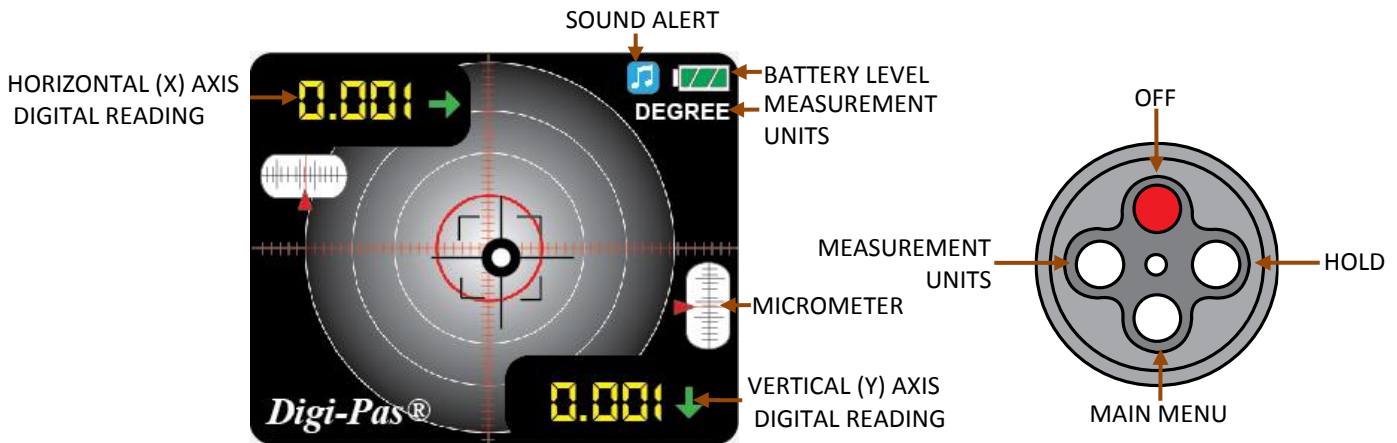

Dual-Axis Mode Operation



Place the digital level on the surface to be measured.



Please ensure the contact surfaces of the device and measuring plane are clean and free from dust particles.



The “Target Ball” or “Bull Eye” move towards the measured position similar to traditional "Bubble" vials. The green arrow sign on display indicates the higher side of plane.



Once the measurement stabilizes, the “Target Ball” or “Bull Eye” blinks.

Main Menu Icon Screen Display and Button Function



DWL3500XY Device



DWL3500XY Bluetooth Device

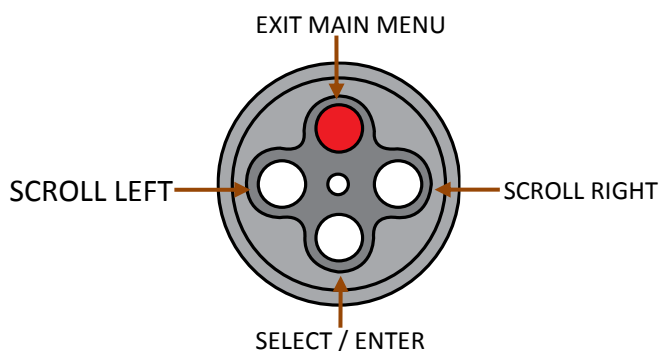

Main Menu Icon Features



ABSOLUTE LEVEL SETTING

Enable user to ensure each measurement reading is in accordance to maximum device accuracy specified.



ALTERNATE ZERO SETTING

Enable user to measure relative angles at a common plane with respect to a reference angle. Set any angle to 0.000° as a reference.



SYNC MENU

Enables user to select the connectivity (USB/Bluetooth) with a computer installed with PC Sync Software.

This feature is only applicable to DWL3500XY Bluetooth device.



ANGLE METER

Enables user to obtain real-time continuous angle measurements displayed in line graph.



VIBRO METER

Enables user to obtain real-time continuous vibration measurements displayed in line graph.



SETTING MENU

Enable user to modify various parameters of the device.



HELP MENU

Enable user to have a quick and easy reference on Device's button configuration. For DWL3500XY Bluetooth device, the HELP icon is represented as  instead.

CHAPTER 4: FEATURES AND SETTING



Absolute Level Screen Display and Button Function

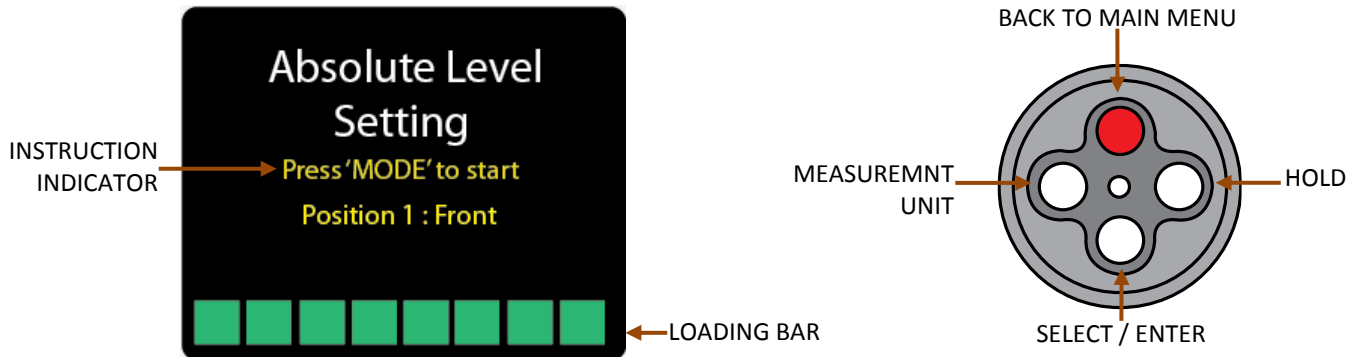

Absolute Level Setting

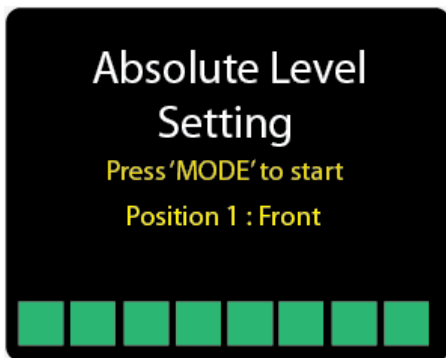

Place the device on the surface to be measured. Press MODE button to start the measurement and wait until the loading bar is full.



Please ensure the contact surfaces of the device and measuring plane are clean and free from dust particles.

Note: The device is able to auto detect its position is single axis position or dual-axis.



Turn the device 180° and press MODE button again to start the measurement.



When completed the above settings, the  logo is shown to indicate that the device is in the Absolute Level mode.



Alternate Zero Screen Display and Button Function

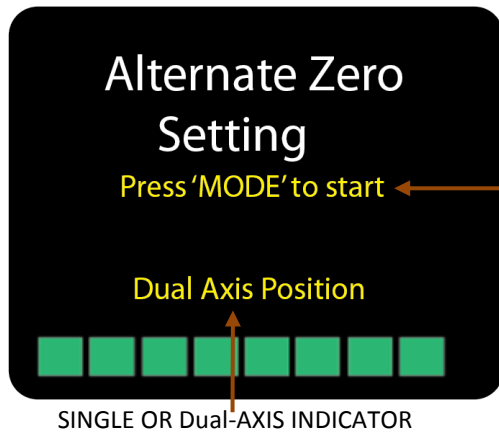

INSTRUCTION INDICATOR

MEASUREMENT UNIT

BACK TO MAIN MENU

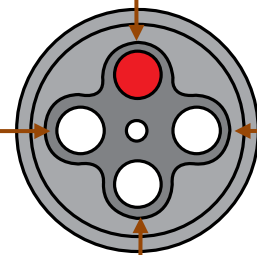

HOLD

SELECT / ENTER

Alternate Zero Setting

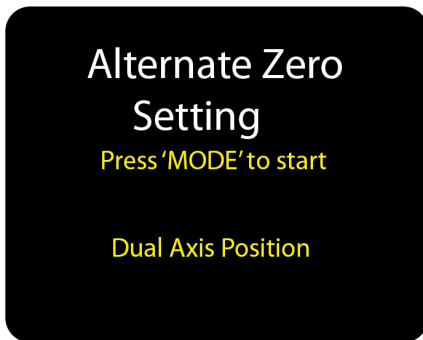

Place the digital level on the surface to be measured. Press MODE button to set the angle to 0.000° as a reference.



Please ensure the contact surfaces of the device and measuring plane are clean and free from dust particles.

Note: The device is able to auto detect its position is single axis position or 2-axis.



The  logo is shown to indicate that the device is in Alternate Zero mode.

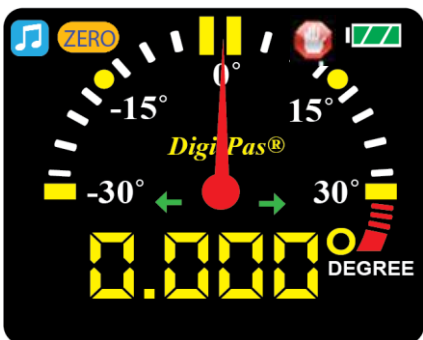

User may “freeze” the screen by pressing the HOLD button.

The icon  pops up to indicate the screen is paused. To resume operation, press the hold button once.



SYNC Menu Screen Display and Button Function

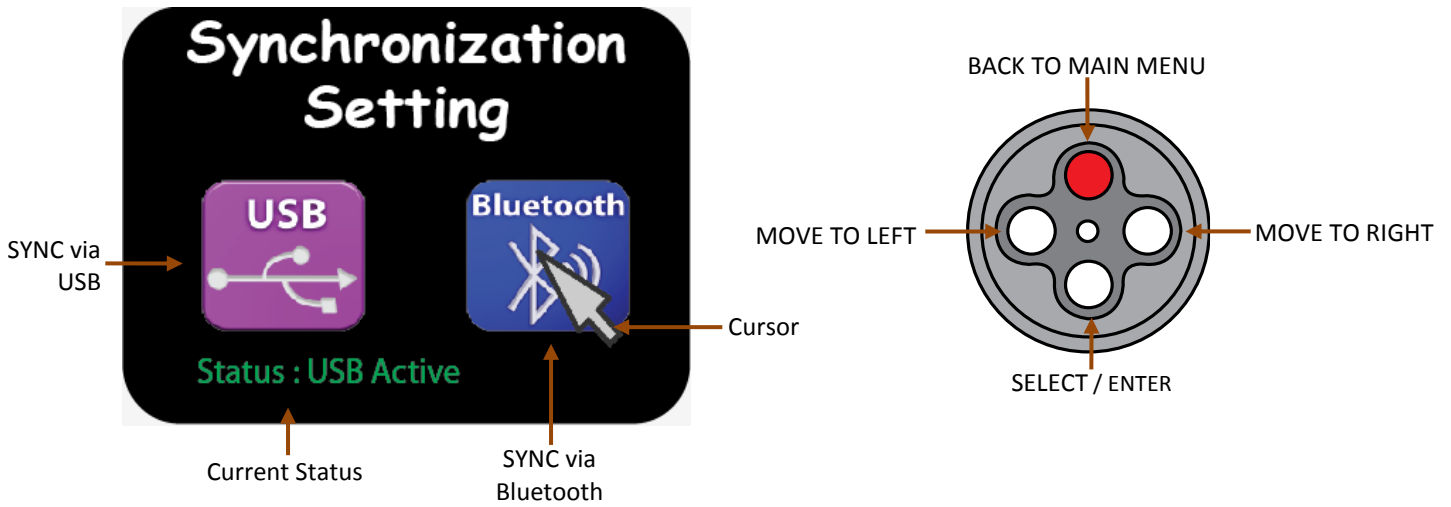

SYNC Menu Setting

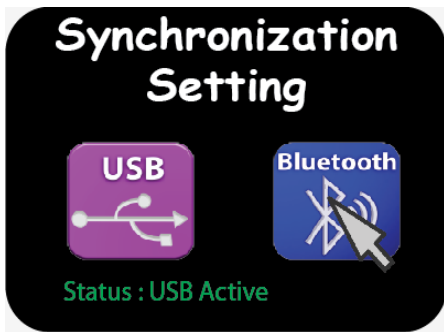

The status bar indicates current selected mode as USB. To change to Bluetooth mode, scroll the 'right' button and then press MODE button.

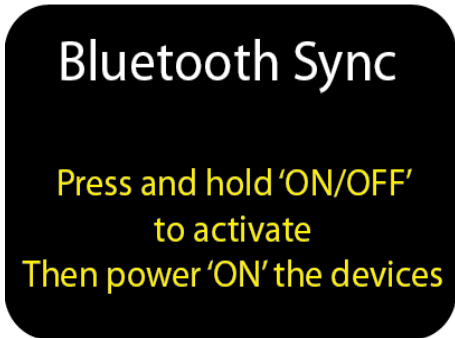

Reboot the device by turning off the device and then turn on the device again to activate the new setting.

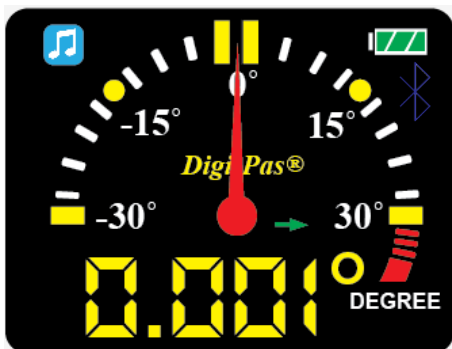

Once Bluetooth mode is activated, the icon  will display on the single and dual-axis mode screen display.



Angle Meter Screen Display and Button Function

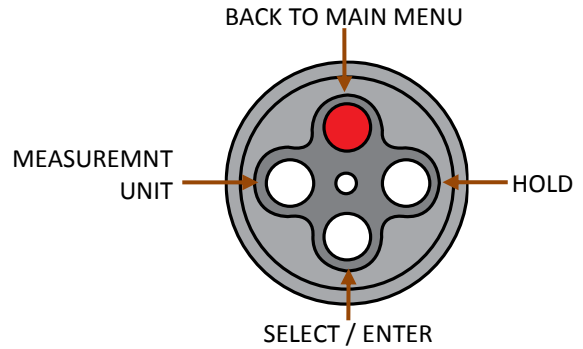
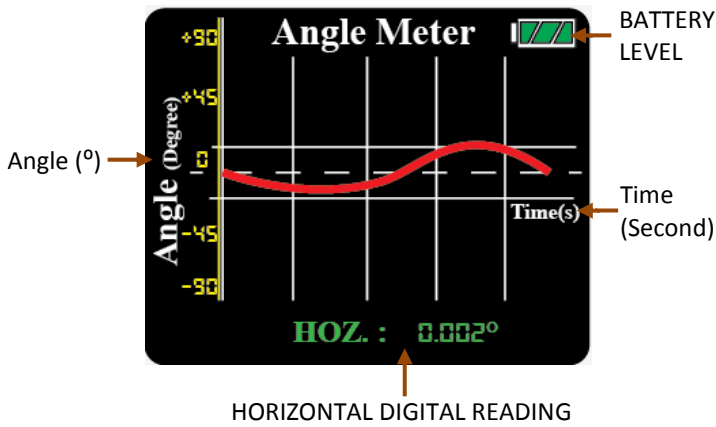

Angle Meter Setting

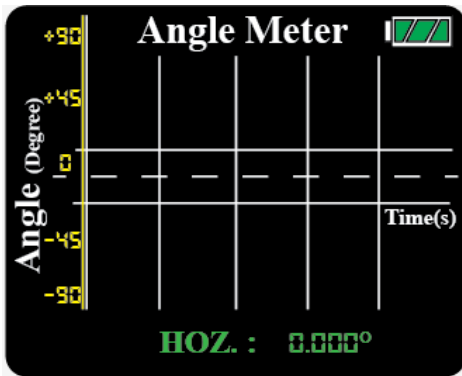

Place the digital level on the surface to be measured.



Please ensure the contact surfaces of the device and measuring plane are clean and free from dust particles.

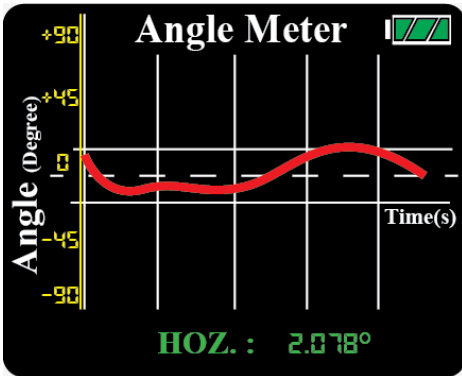

The Angle Meter displays real-time continuous angle measurements in line graph.

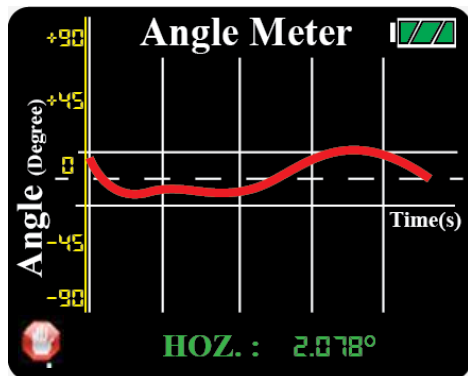

User may “freeze” the screen by pressing the HOLD button.



The icon pops up to indicate the screen is paused. To resume operation, press the hold button once.



Vibro Meter Screen Display and Button Function

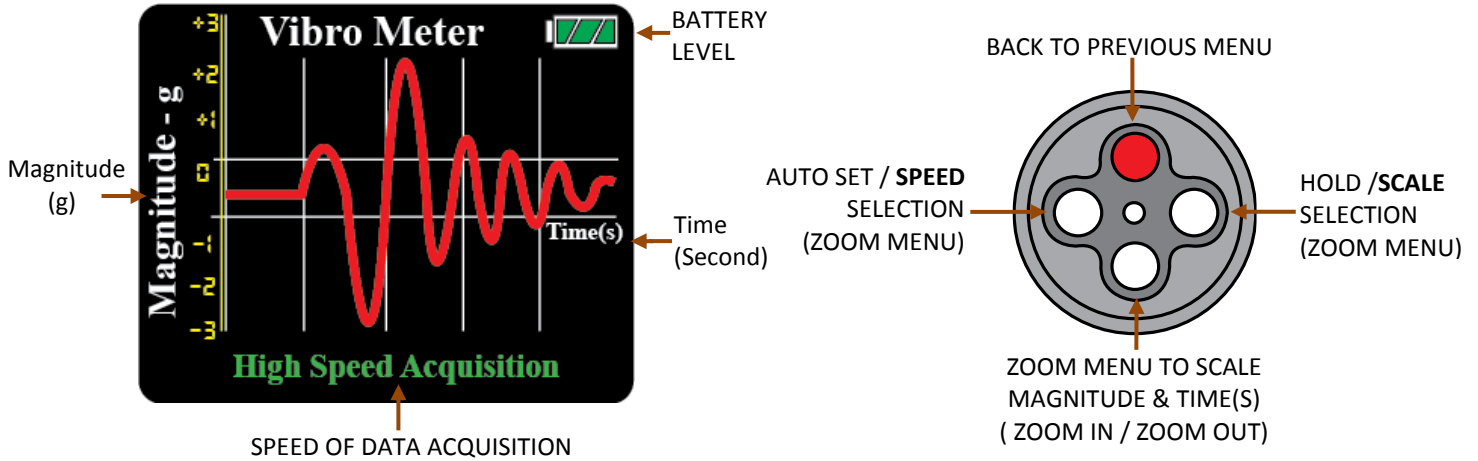

Vibro Meter Setting

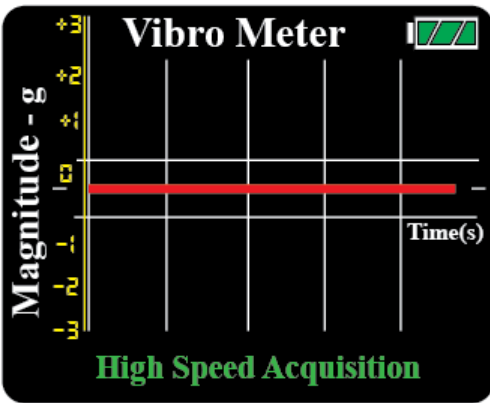

Place the device on the surface to be measured.

Press AutoSet button to set the line graph to the centre of display.



Please ensure the contact surfaces of the device and measuring plane are clean and free from dust particles.

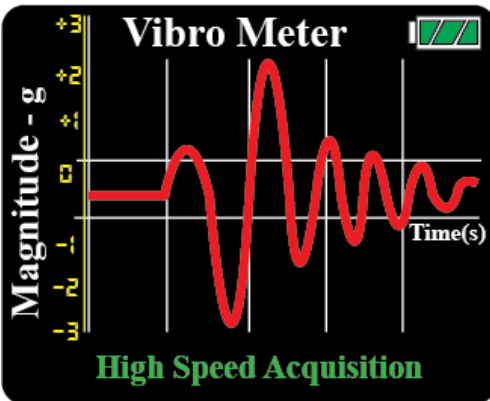

When the device detect the vibration, the relative magnitude (g) is shown on the graph.

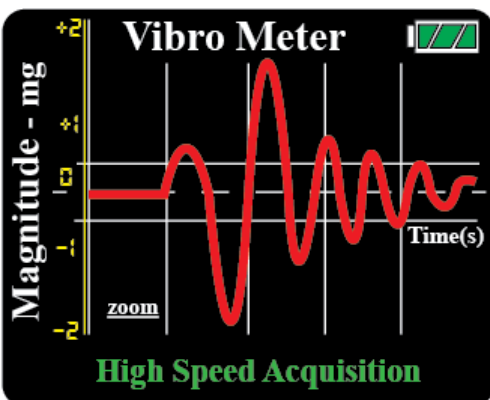

To change the scale and speed of the line graph, press the scale selection button or the speed selection button accordingly.



Setting Menu Display Screen and Button Function

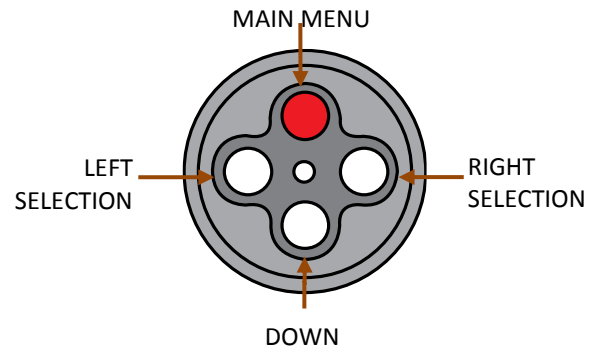
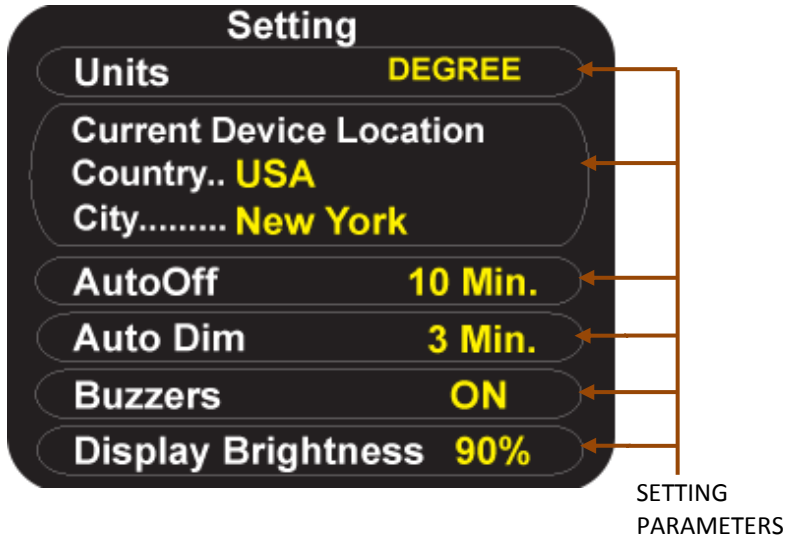

Units	To change the measuring unit (DEGREE, mm/M, IN/FEET).
Current Device Location	To change the location of the device when you use it in a different country or city. Select the nearest option when your location is not available in the default list.
Auto Off	To set automatic power off according to user defined time period.
Auto Dim	To set automatic dim according to user defined time period.
Buzzer	To turn on/off the device buzzer.
Display Brightness	To set LCD brightness according to user defined level.

CHAPTER 5: STORAGE AND CLEANING

Storage

Keep the device in the equipment box and maintain the storage temperature within -20°C to 60°C or -4°F to 140°F.

When the device is not in used, the batteries are to be removed from the device.



Cleaning

1. Keep the device dry and clean. Remove any moisture or dirt with a soft dry cloth before measurement to obtain the maximum accuracy. Do not use harsh chemicals, strong detergents or cleaning solvent to clean the device.
2. Do not submerge device in liquid while cleaning.

CHAPTER 6: WARRANTY

Digi-Pas® 2-Axis High Precision Digital level is warranted to the original purchaser to be free from defects in workmanship and material. JSB Tech will, at its option, repair or replace any defective part which may malfunction under normal and proper use within a period of 2 (two) years from the date of purchase. The forgoing warranty shall not apply to defects resulting from misuse, abuse, assignment, or transfer by the Buyer. Buyer-supplied software or interfacing, unauthorized modification or operation outside of environment specifications for the product. JSB Tech does not warrant that the operation of instrument software, or firmware, will be uninterrupted or error free. The exclusive remedy under any and all warrants and guarantees, expressed herein, and we shall not be liable for damages from loss or delay of equipment uses, consequential, or incidental damage. No other Warranty is expressed or implied. JSB Tech specifically disclaims the implied warranties of merchantability and fitness for a particular purpose.

Limitation of Liability:

In no event shall DIGIPAS TECHNOLOGIES INC, (hereinafter, “the Company”) be liable to you or any third party for any indirect, special, incidental, exemplary or consequential damages of any kind resulting from any breach of warranty or from the performance or use of the product. This includes without limitation: property damage, loss of value of the product or any third party products that are used with the product, or loss of use of the product or any third party products that are used with the product, even if the Company has been advised of the possibility of such loss or damages. The Company’s total cumulative liability arising from or related to the product, whether in contract, tort (including negligence) or otherwise, shall not exceed the amount actually paid by you for the product. Some states and/or jurisdictions do not allow the exclusion or limitation of incidental or consequential damages, so the above limitations or exclusions may not apply to you. If any limitation of liability shall be deemed invalid by any applicable law, then the limitations of liability set forth above shall apply to the maximum extent permitted under applicable law.

Distributed by:

Manufactured by:

JSB TECH PTE LTD

Email:info@digipas.com

www.digipas.com

APPENDIX: USER CALIBRATION

Calibration Instruments:

Granite Table	Grade AA (Levelled to ≤ 1.0 arcsec)
---------------	------------------------------------------

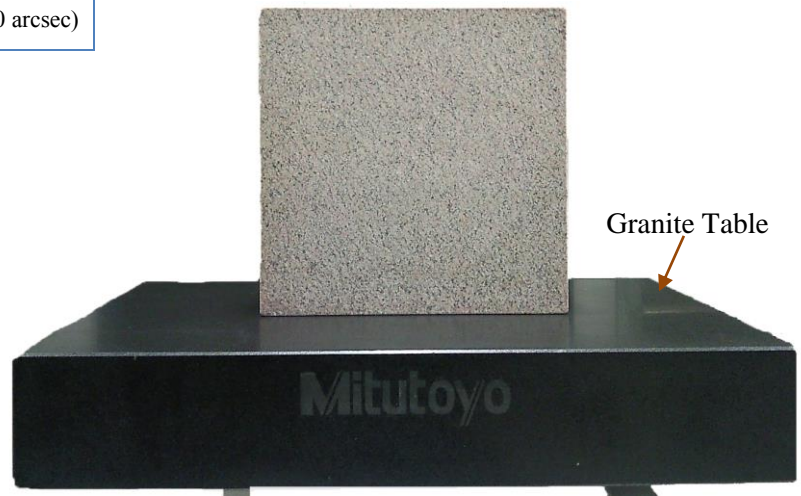

Calibration Procedures:



Ensure the DWL3500XY device is in power OFF condition. Press and hold the CAL button by using a small pin and simultaneously press the ON/OFF button. The LCD screen displays “Calibration 1”.



Position 1

1. Place the device to **Position 1**. Press the MODE button once and wait until the countdown reach “0”, the LCD screen displays “Calibration 2”.



Position 2

2. Turn the device 180° to **Position 2**. Press the MODE button again to start the calibration at “Position 2” and wait until the countdown reach “0”, the LCD screen displays “Calibration 3”.



Position 3

3. Place the device to **Position 3**. Press the MODE button once and wait until the countdown reach "0", the LCD screen displays "Calibration 3" .



Position 4

4. Turn the device 180° to **Position 4**. Press the MODE button again and wait until the countdown reach "0", the LCD screen will switch to measuring mode once calibration is completed.

Precaution:

To achieve maximum accuracy, the device must be held firmly on to jig during calibration process. Any movement on countdown during each calibration procedure would affect device accuracy.