

## 2A, 100V - 200V Ultra Fast Surface Mount Rectifier

### FEATURES

- AEC-Q101 qualified
- Planar technology
- Low power loss, high efficiency
- Ideal for automated placement
- Moisture sensitivity level: level 1, per J-STD-020
- RoHS Compliant
- Halogen-free according to IEC 61249-2-21

### APPLICATIONS

- High frequency switching
- DC/DC
- Snubber

### MECHANICAL DATA

- Case: DO-214AA (SMB)
- Molding compound meets UL 94V-0 flammability rating
- Terminal: Matte tin plated leads, solderable per J-STD-002
- Meet JESD 201 class 2 whisker test
- Polarity: Indicated by cathode band
- Weight: 0.087g (approximately)

KEY PARAMETERS		
PARAMETER	VALUE	UNIT
$I_F$	2	A
$V_{RRM}$	100 - 200	V
$I_{FSM}$	50	A
$T_{JMAX}$	175	°C
Package	DO-214AA (SMB)	
Configuration	Single die	



DO-214AA (SMB)



ABSOLUTE MAXIMUM RATINGS ( $T_A = 25^\circ\text{C}$ unless otherwise noted)				
PARAMETER	SYMBOL	PE2BBH	PE2DBH	UNIT
Marking code on the device		PE2BB	PE2DB	
Repetitive peak reverse voltage	$V_{RRM}$	100	200	V
Reverse voltage, total rms value	$V_{R(RMS)}$	70	140	V
Forward current	$I_F$	2		A
Surge peak forward current single half sine-wave superimposed on rated load	$t = 8.3\text{ms}$	50		A
	$t = 1.0\text{ms}$	130		
Junction temperature	$T_J$	-55 to +175		°C
Storage temperature	$T_{STG}$	-55 to +175		°C

<b>THERMAL PERFORMANCE</b>			
<b>PARAMETER</b>	<b>SYMBOL</b>	<b>TYP</b>	<b>UNIT</b>
Junction-to-lead thermal resistance	$R_{\theta JL}$	18	°C/W
Junction-to-ambient thermal resistance	$R_{\theta JA}$	67	°C/W
Junction-to-case thermal resistance	$R_{\theta JC}$	19	°C/W

**Thermal Performance Note:** Units mounted on PCB (10mm x 10mm Cu pad test board)

<b>ELECTRICAL SPECIFICATIONS</b> ( $T_A = 25^\circ\text{C}$ unless otherwise noted)					
<b>PARAMETER</b>	<b>CONDITIONS</b>	<b>SYMBOL</b>	<b>TYP</b>	<b>MAX</b>	<b>UNIT</b>
Forward voltage <sup>(1)</sup>	$I_F = 1\text{A}, T_J = 25^\circ\text{C}$	$V_F$	0.81	-	V
	$I_F = 2\text{A}, T_J = 25^\circ\text{C}$		0.87	0.90	V
	$I_F = 1\text{A}, T_J = 125^\circ\text{C}$		0.65	-	V
	$I_F = 2\text{A}, T_J = 125^\circ\text{C}$		0.72	-	V
Reverse current @ rated $V_R$ <sup>(2)</sup>	$T_J = 25^\circ\text{C}$	$I_R$	-	2	$\mu\text{A}$
	$T_J = 125^\circ\text{C}$		-	10	$\mu\text{A}$
Junction capacitance	1MHz, $V_R = 4.0\text{V}$	$C_J$	30	-	pF
Reverse recovery time	$I_F = 0.5\text{A}, I_R = 1.0\text{A}, I_{rr} = 0.25\text{A}$	$t_{rr}$	-	20	ns
	$I_F = 1.0\text{A}, di/dt = 50\text{A}/\mu\text{s}, V_R = 30\text{V}$		24	-	
Reverse recovery current	$I_F = 2.0\text{A}, di/dt = 200\text{A}/\mu\text{s}, V_R = 100\text{V}$	$I_{RM}$	2.7	-	A
Reverse recovery charge		$Q_{rr}$	17.4	-	nC
Reverse recovery time		$t_{rr}$	14	-	ns

**Notes:**

1. Pulse test with PW = 0.3ms
2. Pulse test with PW = 30ms

<b>ORDERING INFORMATION</b>		
<b>ORDERING CODE<sup>(1)</sup></b>	<b>PACKAGE</b>	<b>PACKING</b>
PE2xBH	DO-214AA (SMB)	3,000/ Tape & Reel

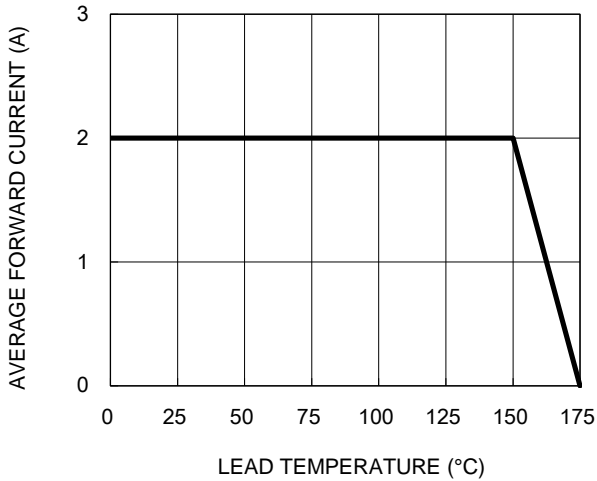
**Notes:**

1. "x" defines voltage from 100V(PE2BBH) to 200V(PE2DBH)

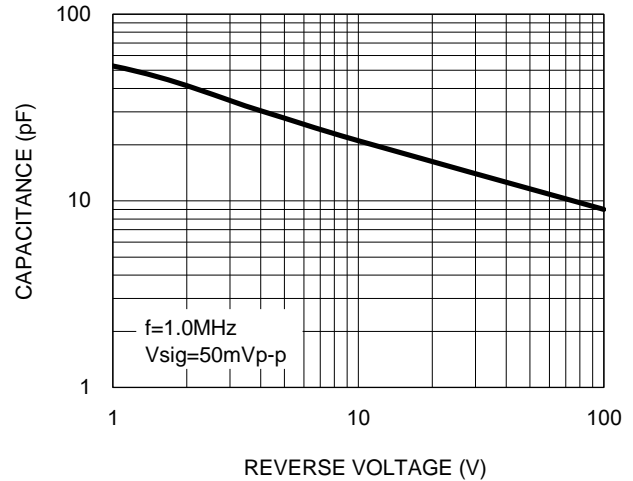
**CHARACTERISTICS CURVES**

( $T_A = 25^\circ\text{C}$  unless otherwise noted)

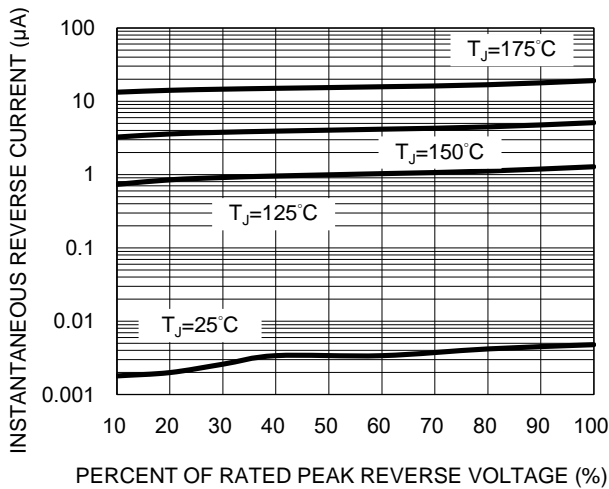
**Fig.1 Forward Current Derating Curve**



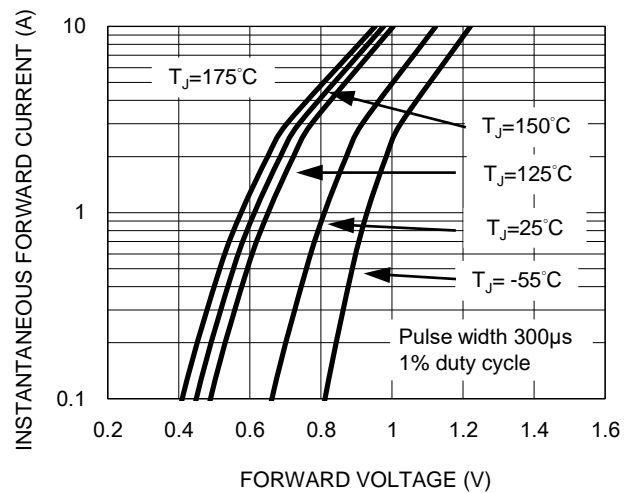
**Fig.2 Typical Junction Capacitance**



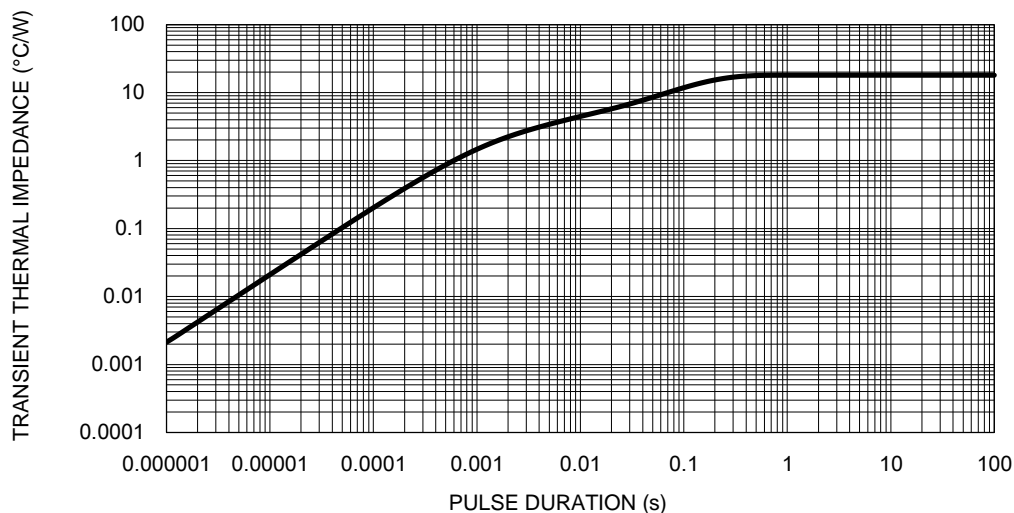
**Fig.3 Typical Reverse Characteristics**



**Fig.4 Typical Forward Characteristics**

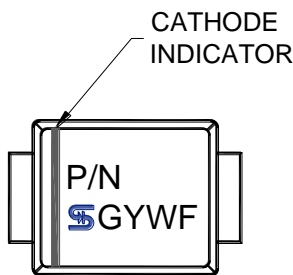
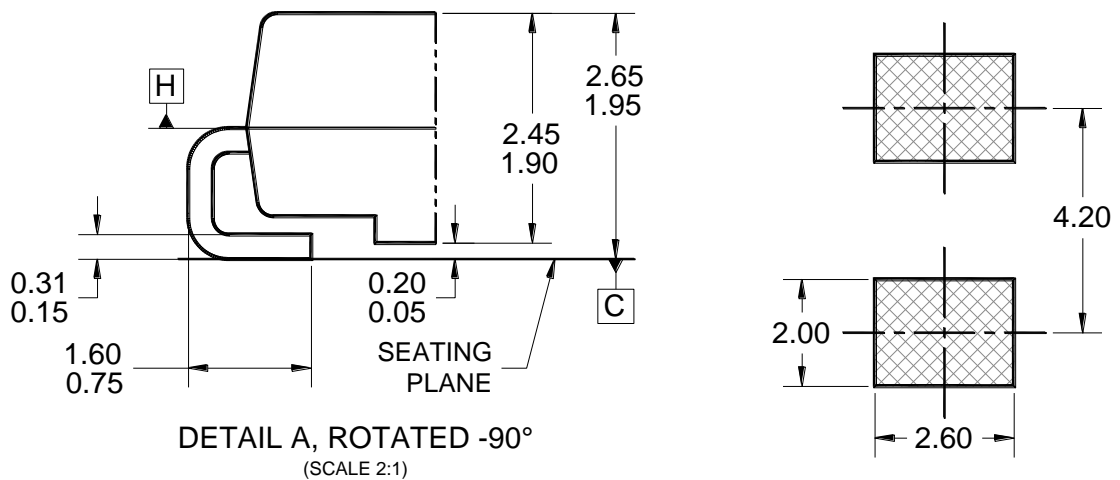
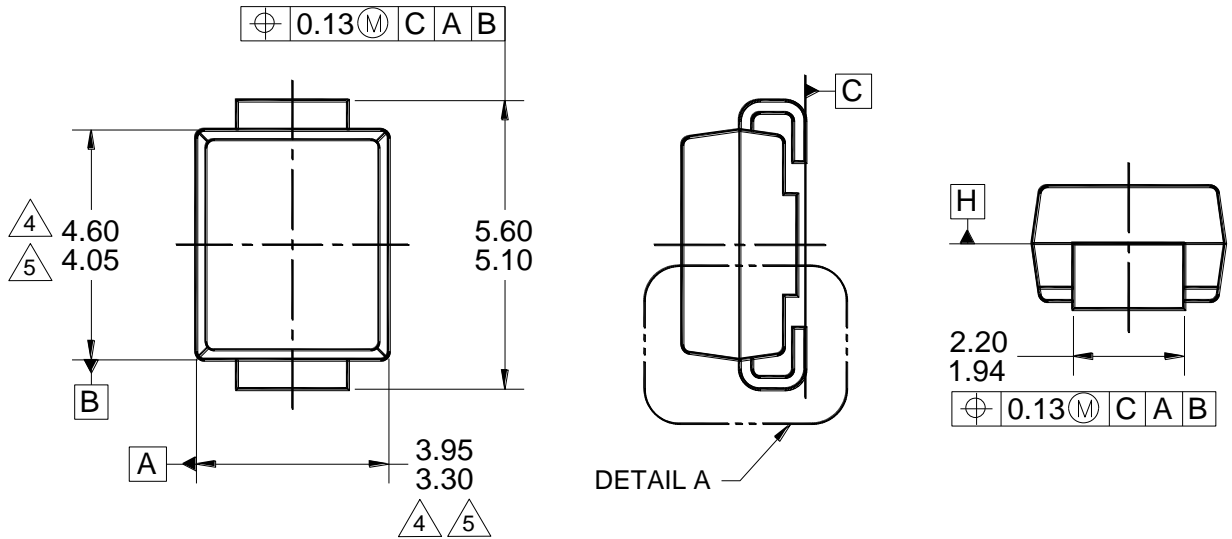


**Fig.5 Typical Transient Thermal Impedance**



**PACKAGE OUTLINE DIMENSIONS**

**DO-214AA (SMB)**



**MARKING DIAGRAM**

P/N = MARKING CODE  
G = GREEN COMPOUND  
YW = DATE CODE  
F = FACTORY CODE

**NOTES: UNLESS OTHERWISE SPECIFIED**

- ALL DIMENSIONS ARE IN MILLIMETERS.
- DIMENSIONING AND TOLERANCING PER ASME Y14.5M-1994.
- PACKAGE OUTLINE REFERENCE: JEDEC DO-214, VARIATION AA, ISSUE D.
- MOLDED PLASTIC BODY DIMENSIONS DO NOT INCLUDE MOLD FLASH.
- MOLDED PLASTIC BODY LATERAL DIMENSIONS TO BE DETERMINED AT DATUM PLANE H.
- DWG NO. REF: HQ2SD07-DO214SMB-035 REV A.

## Notice

Specifications of the products displayed herein are subject to change without notice. TSC or anyone on its behalf, assumes no responsibility or liability for any errors or inaccuracies.

Purchasers are solely responsible for the choice, selection, and use of TSC products and TSC assumes no liability for application assistance or the design of Purchasers' products.

Information contained herein is intended to provide a product description only. No license, express or implied, to any intellectual property rights is granted by this document. Except as provided in TSC's terms and conditions of sale for such products, TSC assumes no liability whatsoever, and disclaims any express or implied warranty, relating to sale and/or use of TSC products including liability or warranties relating to fitness for a particular purpose, merchantability, or infringement of any patent, copyright, or other intellectual property right.

The products shown herein are not designed for use in medical, life-saving, or life-sustaining applications. Customers using or selling these products for use in such applications do so at their own risk and agree to fully indemnify TSC for any damages resulting from such improper use or sale.