

Product Summary

V_PT (Min)	I_{PP} (Max)	C_T (Typ)
3.6V	80A	2.1pF

Description

The DIODES™ D3V3F4U8MR of transient voltage suppressors are designed to protect low voltage. This has been specifically designed to protect sensitive components which are connected to high-speed data and transmission lines from overvoltage caused by ESD (electrostatic discharge), CDE (cable discharge events), and FET (fast electrical transients).

Applications

- 10/100 Ethernet
- WAN/LAN equipment
- Switching systems
- Desktops, servers, and notebooks
- Base stations

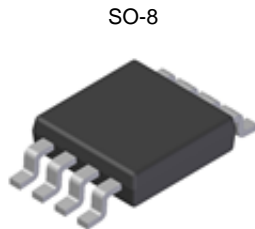

Top View

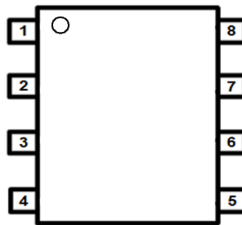

Top View
Pin Configuration

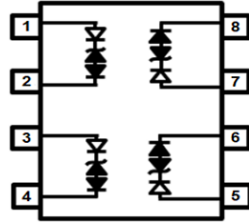

Device Schematic

Features

- Protects Two Line Pairs (Four Lines)
- Low Capacitance < 3pF for High-Speed Interfaces
- Low Operating and Clamping Voltages
- IEC 61000-4-2, Level 4 (ESD), <= ±15kV (Air); <= ±8kV (Contact)
- IEC 61000-4-5, Level 3 (Lightning), 48A (8/20µs)
- **Totally Lead-Free & Fully RoHS Compliant (Notes 1 & 2)**
- **Halogen and Antimony Free. “Green” Device (Note 3)**
- **For automotive applications requiring specific change control (i.e. parts qualified to AEC-Q100/101/104/200, PPAP capable, and manufactured in IATF 16949 certified facilities), please [contact us](mailto:contact@diodes.com) or your local Diodes representative. <https://www.diodes.com/quality/product-definitions/>**

Mechanical Data

- Package: SO-8
- Package Material: Molded Plastic, “Green” Molding Compound. UL Flammability Classification Rating 94V-0
- Moisture Sensitivity: Level 1 per J-STD-020
- Terminals: Matte Tin Finish Annealed over Copper Leadframe (Lead Free Plating). Solderable per MIL-STD-202, Method 208 (E3)
- Weight: 0.08 grams (Approximate)

Ordering Information (Note 4)

Part Number	Package	Marking	Reel Size (inches)	Tape Width (mm)	Packing	
					Qty.	Carrier
D3V3F4U8MR-13	SO-8	3V3K8-4	13	12	2,500	Tape & Reel

- Notes:
1. No purposely added lead. Fully EU Directive 2002/95/EC (RoHS), 2011/65/EU (RoHS 2) & 2015/863/EU (RoHS 3) compliant.
 2. See <https://www.diodes.com/quality/lead-free/> for more information about Diodes Incorporated's definitions of Halogen- and Antimony-free, "Green" and Lead-free.
 3. Halogen- and Antimony-free "Green" products are defined as those which contain <900ppm bromine, <900ppm chlorine (<1500ppm total Br + Cl) and <1000ppm antimony compounds.
 4. For packaging details, go to our website at <https://www.diodes.com/design/support/packaging/diodes-packaging/>.

Marking Information

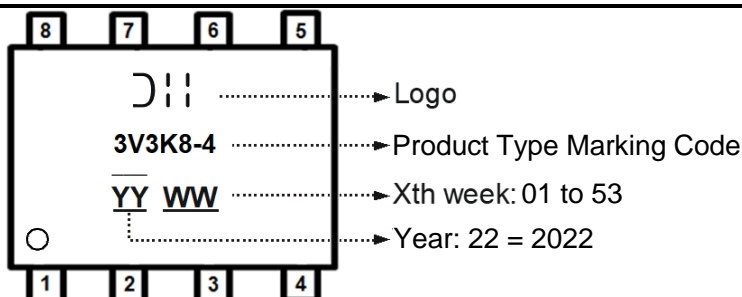

Maximum Ratings (@T_A = +25°C, unless otherwise specified.)

Characteristic	Symbol	Value	Unit	Conditions
Peak Pulse Power Dissipation	P _{PP}	1000	W	8/20μs, per Figure 1
Peak Pulse Current	I _{PP}	80	A	8/20μs, per Figure 1
ESD Protection – Contact Discharge	V _{ESD_Contact}	±8	kV	IEC 61000-4-2 Standard
ESD Protection – Air Discharge	V _{ESD_Air}	±15	kV	IEC 61000-4-2 Standard

Thermal Characteristics

Characteristic	Symbol	Value	Unit
Package Power Dissipation (Note 5)	P _D	500	mW
Thermal Resistance, Junction to Ambient (Note 5)	R _{θJA}	56.50	°C/W
Operating Temperature Range	T _J	-55 to +125	°C
Storage Temperature Range	T _{STG}	-55 to +150	°C
Soldering Temperature, t _{max} = 10s	T _L	+260	°C

Electrical Characteristics (@T_A = +25°C, unless otherwise specified.)

Characteristic	Symbol	Min	Typ	Max	Unit	Test Conditions
Reverse Standoff Voltage	V _{RWM}	—	—	3.3	V	—
Channel Leakage Current (Note 6)	I _{RM}	—	—	1	μA	V _{RWM} = 3.3V
Punch Through Voltage	V _{PT}	3.6	—	—	V	I _{PT} = 2μA
Snap-Back Voltage	V _{SB}	3.3	—	—		I _{SB} = 50mA
Clamping Voltage, Positive Transients	V _{CL}	—	—	5	V	I _{PP} = 1A, t _p = 8/20μs, Figure 1
		—	—	17		I _{PP} = 48A, t _p = 8/20μs, Figure 1
		—	—	20		I _{PP} = 80A, t _p = 8/20μs, Figure 1
Channel Input Capacitance	C _T	—	2.1	3	pF	V _R = 0V, f = 1MHz, each line

Notes: 5. Device mounted on FR-4 PCB pad layout (2oz copper) as shown on our website at <http://www.diodes.com/package-outlines.html>.
 6. Short duration pulse test used to minimize self-heating effect.

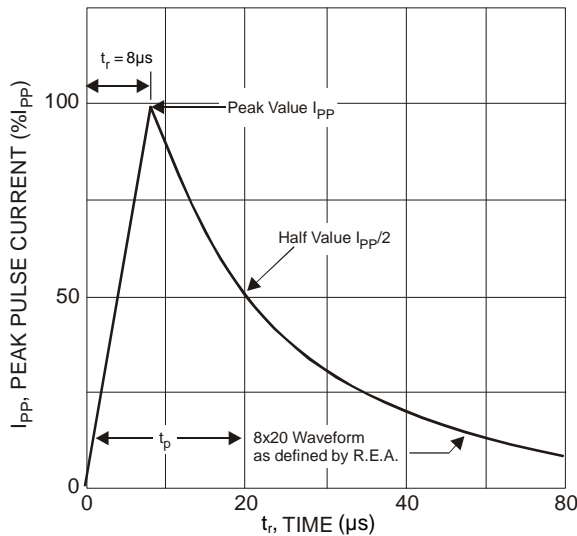
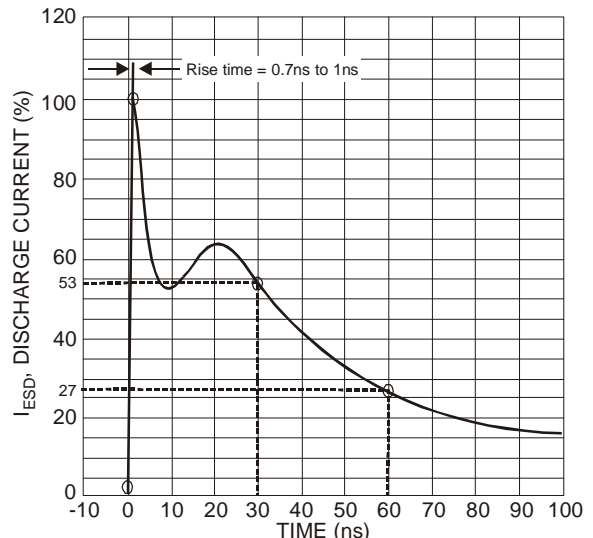

Figure 1. Pulse Waveform

 Figure 2. ESD Discharge Current Wave Form
 IEC 61000-4-2 (330Ω/150pF)

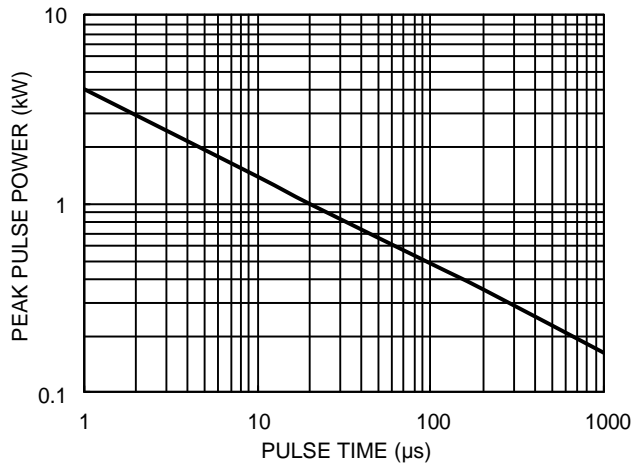

Figure 3. Power Dissipation vs. Pulse Time

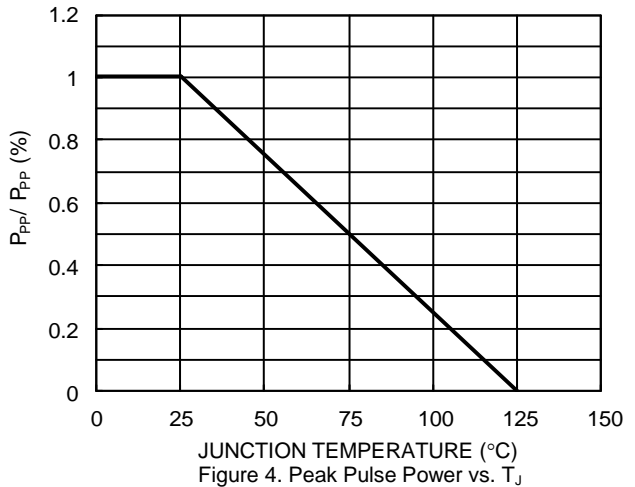

Figure 4. Peak Pulse Power vs. T_J

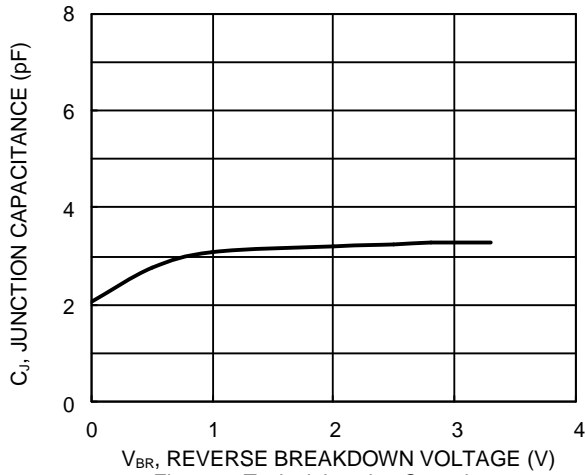

Figure 5. Typical Junction Capacitance

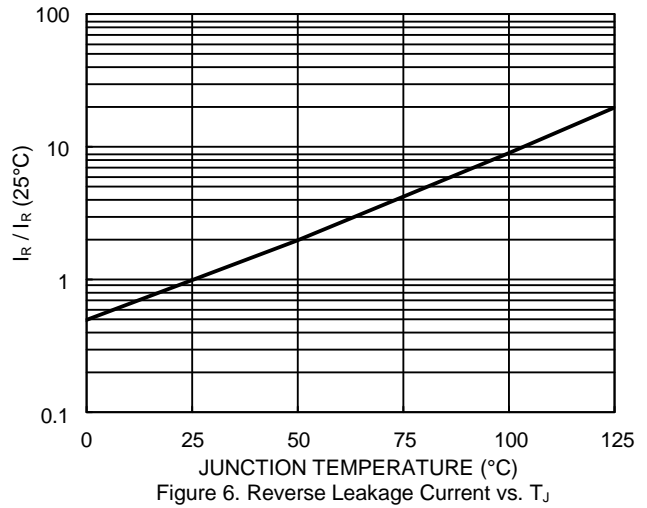

Figure 6. Reverse Leakage Current vs. T_J

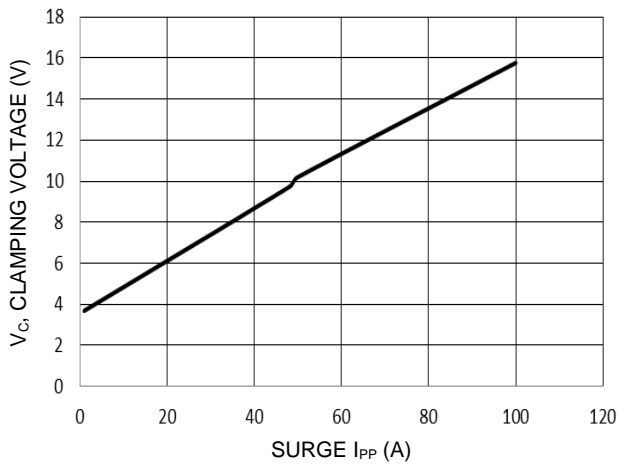

Figure 7. Clamping Voltage Characteristics ($t_p = 8/20\mu s$)

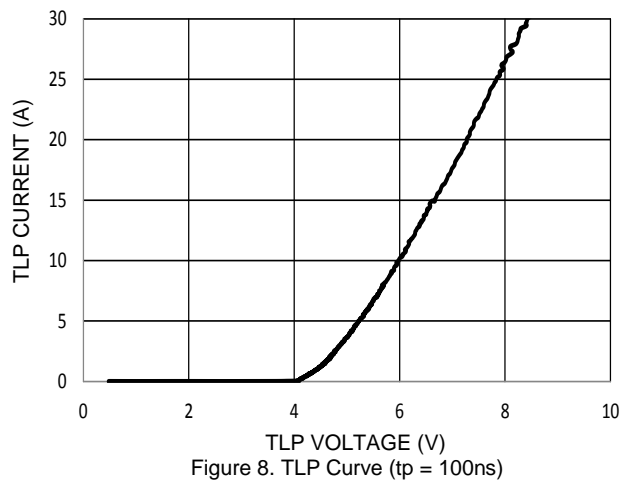
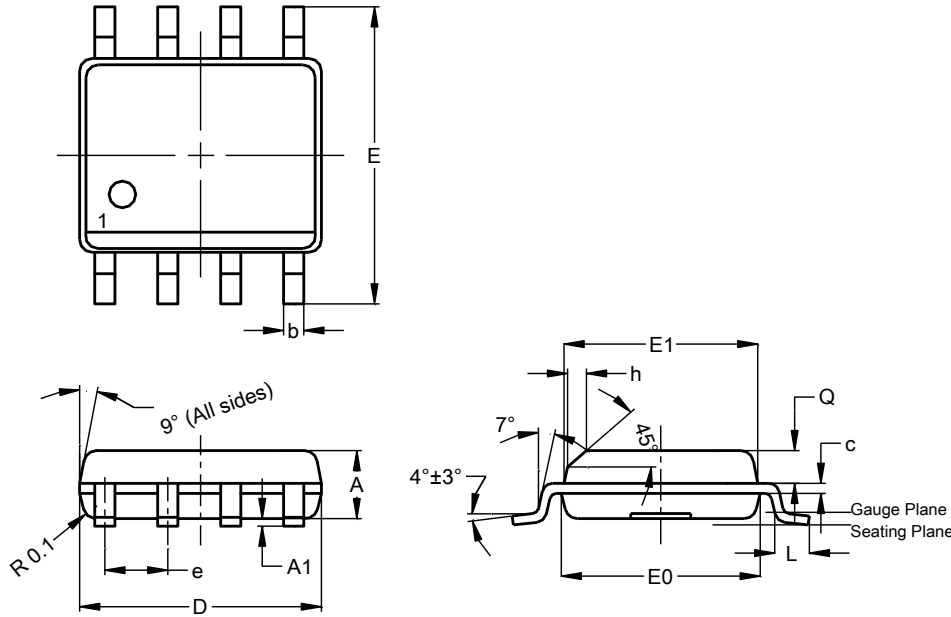

Figure 8. TLP Curve ($t_p = 100ns$)

Package Outline Dimensions

Please see <http://www.diodes.com/package-outlines.html> for the latest version.

SO-8



SO-8			
Dim	Min	Max	Typ
A	1.40	1.50	1.45
A1	0.10	0.20	0.15
b	0.30	0.50	0.40
c	0.15	0.25	0.20
D	4.85	4.95	4.90
E	5.90	6.10	6.00
E1	3.80	3.90	3.85
E0	3.85	3.95	3.90
e	--	--	1.27
h	-	--	0.35
L	0.62	0.82	0.72
Q	0.60	0.70	0.65
All Dimensions in mm			

Suggested Pad Layout

Please see <http://www.diodes.com/package-outlines.html> for the latest version.

SO-8

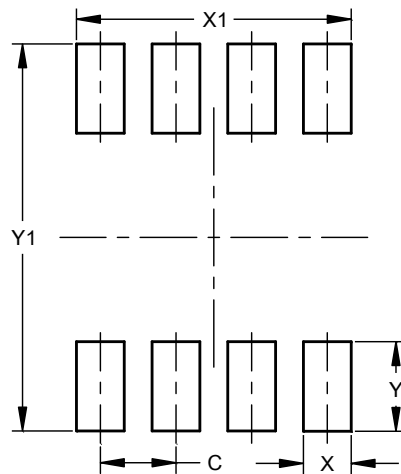

Dimensions	Value (in mm)
C	1.27
X	0.802
X1	4.612
Y	1.505
Y1	6.50

IMPORTANT NOTICE

1. DIODES INCORPORATED (Diodes) AND ITS SUBSIDIARIES MAKE NO WARRANTY OF ANY KIND, EXPRESS OR IMPLIED, WITH REGARDS TO ANY INFORMATION CONTAINED IN THIS DOCUMENT, INCLUDING, BUT NOT LIMITED TO, THE IMPLIED WARRANTIES OF MERCHANTABILITY, FITNESS FOR A PARTICULAR PURPOSE OR NON-INFRINGEMENT OF THIRD PARTY INTELLECTUAL PROPERTY RIGHTS (AND THEIR EQUIVALENTS UNDER THE LAWS OF ANY JURISDICTION).
2. The Information contained herein is for informational purpose only and is provided only to illustrate the operation of Diodes' products described herein and application examples. Diodes does not assume any liability arising out of the application or use of this document or any product described herein. This document is intended for skilled and technically trained engineering customers and users who design with Diodes' products. Diodes' products may be used to facilitate safety-related applications; however, in all instances customers and users are responsible for (a) selecting the appropriate Diodes products for their applications, (b) evaluating the suitability of Diodes' products for their intended applications, (c) ensuring their applications, which incorporate Diodes' products, comply the applicable legal and regulatory requirements as well as safety and functional-safety related standards, and (d) ensuring they design with appropriate safeguards (including testing, validation, quality control techniques, redundancy, malfunction prevention, and appropriate treatment for aging degradation) to minimize the risks associated with their applications.
3. Diodes assumes no liability for any application-related information, support, assistance or feedback that may be provided by Diodes from time to time. Any customer or user of this document or products described herein will assume all risks and liabilities associated with such use, and will hold Diodes and all companies whose products are represented herein or on Diodes' websites, harmless against all damages and liabilities.
4. Products described herein may be covered by one or more United States, international or foreign patents and pending patent applications. Product names and markings noted herein may also be covered by one or more United States, international or foreign trademarks and trademark applications. Diodes does not convey any license under any of its intellectual property rights or the rights of any third parties (including third parties whose products and services may be described in this document or on Diodes' website) under this document.
5. Diodes' products are provided subject to Diodes' Standard Terms and Conditions of Sale (<https://www.diodes.com/about/company/terms-and-conditions/terms-and-conditions-of-sales/>) or other applicable terms. This document does not alter or expand the applicable warranties provided by Diodes. Diodes does not warrant or accept any liability whatsoever in respect of any products purchased through unauthorized sales channel.
6. Diodes' products and technology may not be used for or incorporated into any products or systems whose manufacture, use or sale is prohibited under any applicable laws and regulations. Should customers or users use Diodes' products in contravention of any applicable laws or regulations, or for any unintended or unauthorized application, customers and users will (a) be solely responsible for any damages, losses or penalties arising in connection therewith or as a result thereof, and (b) indemnify and hold Diodes and its representatives and agents harmless against any and all claims, damages, expenses, and attorney fees arising out of, directly or indirectly, any claim relating to any noncompliance with the applicable laws and regulations, as well as any unintended or unauthorized application.
7. While efforts have been made to ensure the information contained in this document is accurate, complete and current, it may contain technical inaccuracies, omissions and typographical errors. Diodes does not warrant that information contained in this document is error-free and Diodes is under no obligation to update or otherwise correct this information. Notwithstanding the foregoing, Diodes reserves the right to make modifications, enhancements, improvements, corrections or other changes without further notice to this document and any product described herein. This document is written in English but may be translated into multiple languages for reference. Only the English version of this document is the final and determinative format released by Diodes.
8. Any unauthorized copying, modification, distribution, transmission, display or other use of this document (or any portion hereof) is prohibited. Diodes assumes no responsibility for any losses incurred by the customers or users or any third parties arising from any such unauthorized use.
9. This Notice may be periodically updated with the most recent version available at <https://www.diodes.com/about/company/terms-and-conditions/important-notice>

DIODES is a trademark of Diodes Incorporated in the United States and other countries.
The Diodes logo is a registered trademark of Diodes Incorporated in the United States and other countries.
© 2022 Diodes Incorporated. All Rights Reserved.

www.diodes.com