

ASCB-RTF2-0A307

1716 Tricolor PLCC-4 LED

Description

The Broadcom[®] ASCB-RTF2 series are the latest high-brightness tricolor LEDs in targeting small pixel pitch displays. With a 1.7-mm × 1.6-mm PLCC-4 footprint, the ASCB-RTF2 is the right solution for semi outdoor video display. The black outer appearance with diffused epoxy features enhances the end display contrast while maintaining high brightness.

To facilitate easy pick-and-place assembly, the LEDs are packed in tape and reel form. Every reel is shipped in single intensity and color bin to ensure uniformity.

Features

- PLCC-4 package with black outer appearance
- Suitable for small pitch sign
- Short leads for better potting process

Applications

- Video screens

CAUTION! This LED is ESD sensitive. Observe appropriate precautions during handling and processing. Refer to application note AN-1142 for additional details.

Figure 1: Package Drawing

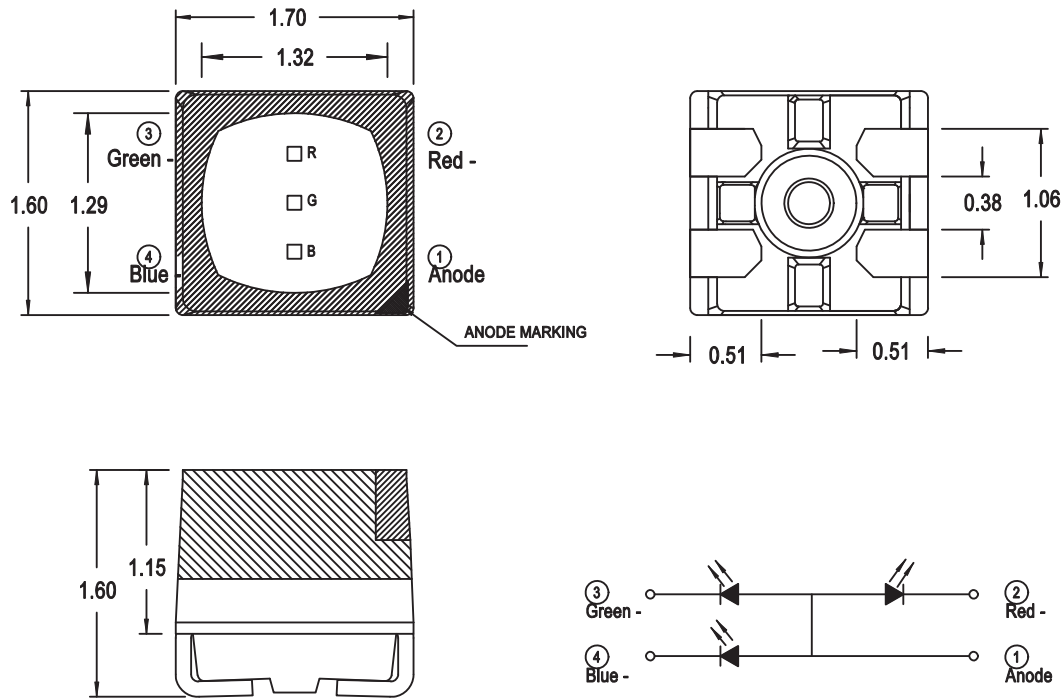

Pin	Configuration
1	Common Anode
2	Red Cathode
3	Green Cathode
4	Blue Cathode

NOTE:

1. All dimensions are in millimeters (mm).
2. Tolerance is ± 0.20 mm unless otherwise specified.
3. Terminal finish = silver plating.

Absolute Maximum Ratings

Parameters	Red	Green	Blue	Units
DC Forward Current ^a	25	20	15	mA
Peak Forward Current ^b	100	100	100	mA
Power Dissipation	60	66	49.5	mW
Reverse Voltage	Not recommended for reverse bias operation			
LED Junction Temperature	100			°C
Operating Temperature Range	-40 to +85			°C
Storage Temperature Range	-40 to +100			°C

a. Derate linearly as shown in Figure 8 and Figure 9.

b. Duty factor = 10%, frequency = 1 kHz.

Optical Characteristics (T_J = 25°C)

Color	Luminous Intensity, I _V (mcd) ^a			Dominant Wavelength, λ _d (nm) ^b			Peak Wavelength, λ _p (nm)	Viewing Angle, 2θ _½ (°) ^c	Test Current (mA)
	Min.	Typ.	Max.	Min.	Typ.	Max.	Typ.	Typ.	
Red	255	335	430	618	621	625	629	105	10
Green	715	900	1210	522	524	532	519	105	10
Blue	85	105	145	467	471	474	468	105	5

a. The luminous intensity, I_V is measured at the mechanical axis of the package and it is tested with a single current pulse condition. The actual peak of the spatial radiation pattern may not be aligned with the axis.

b. The dominant wavelength, λ_d is derived from the CIE Chromaticity Diagram and represents the perceived color of the device.

c. θ_½ is the off-axis angle where the luminous intensity is half of the peak intensity.

Electrical Characteristics (T_J = 25°C)

Color	Forward Voltage V _F (V) ^a			Reverse Voltage, V _R (V) at I _R = 10 μA ^b	Thermal Resistance, R _{θJ-S} (°C/W) ^c
	Min.	Typ.	Max.		3 Chips On
				Typ.	Typ.
Red	1.70	2.00	2.40	4.0	500
Green	2.50	2.90	3.30	4.0	500
Blue	2.50	2.70	3.30	4.0	1000

a. Forward voltage tolerance is ± 0.1V. V_F is tested at test current.

b. Indicates product final test condition. Long term reverse bias is not recommended.

c. Thermal resistance from the LED junction to the solder point.

Part Numbering System

A S C B - R T

x ₁	x ₂
----------------	----------------

 - 0

x ₃	x ₄	x ₅	x ₆
----------------	----------------	----------------	----------------

Code	Description	Option	
x ₁	Package Type	F	Black outer appearance
x ₂	Pin Configuration	2	Common anode
x ₃	Minimum Intensity Bin	A	Red = Bin R1 Green: Bin G1 Blue: Bin B1
			Red: Bin R1, Ra, R2 Green: Bin G1, Ga, G2 Blue: Bin B1, Ba, B2
x ₄	Number of Intensity Bins	3	3 Intensity bins from minimum
x ₅	Color Bin Option	0	Red = Full distribution Green = Bin J, K, L, M, N, P, Q, R Blue = Bin A, B, C, D, E
x ₆	Test Option	7	Test Current: Red 10 mA, Green 10 mA, Blue 5 mA

Bin Information

Intensity Bin Limits (CAT)

Bin ID	Luminous Intensity, IV (mcd)	
	Min.	Max.
Red		
R1	255	330
Ra	290	380
R2	330	430
Green		
G1	715	930
Ga	815	1060
G2	930	1210
Blue		
B1	85	110
Ba	95	125
B2	110	145

Tolerance = ± 12%.

Color Bin Limits (BIN) – Red

Bin ID	Dominant Wavelength, λ _d (nm)		Chromaticity Coordinates	
	Min.	Max.	x	y
—	618	625	0.6873	0.3126
			0.6696	0.3136
			0.6822	0.3010
			0.7006	0.2993

Tolerance = ± 1.0 nm.

Example of bin information on reel and packaging label:

- CAT: R2 G2 B2 – Red intensity bin R2
 – Green intensity bin G2
 – Blue intensity bin B2
- BIN: ME – Green color bin M
 – Blue color bin E

Color Bin Limits (BIN) – Green

Bin ID	Dominant Wavelength, λ_d (nm)		Chromaticity Coordinates	
	Min.	Max.	x	y
J	522	525	0.0899	0.8333
			0.1629	0.6833
			0.1799	0.6783
			0.1142	0.8262
K	523	526	0.0979	0.8316
			0.1686	0.6821
			0.1856	0.6759
			0.1223	0.8228
L	524	527	0.1060	0.8292
			0.1742	0.6804
			0.1914	0.6732
			0.1305	0.8189
M	525	528	0.1142	0.8262
			0.1799	0.6783
			0.1971	0.6703
			0.1387	0.8148
N	526	529	0.1223	0.8228
			0.1856	0.6759
			0.2027	0.6673
			0.1468	0.8104
P	527	530	0.1305	0.8189
			0.1914	0.6732
			0.2083	0.6641
			0.1547	0.8059
Q	528	531	0.1387	0.8148
			0.1971	0.6703
			0.2138	0.6609
			0.1625	0.8012
R	529	532	0.1468	0.8104
			0.2027	0.6673
			0.2192	0.6576
			0.1702	0.7965

Tolerance = ± 1.0 nm.

Color Bin Limits (BIN) – Blue

Bin ID	Dominant Wavelength, λ_d (nm)		Chromaticity Coordinates	
	Min.	Max.	x	y
A	467	470	0.1314	0.0459
			0.1415	0.0602
			0.1346	0.0716
			0.1241	0.0578
B	468	471	0.1291	0.0494
			0.1393	0.0636
			0.1321	0.0761
			0.1215	0.0626
C	469	472	0.1267	0.0534
			0.1370	0.0674
			0.1294	0.0811
			0.1187	0.0678
D	470	473	0.1241	0.0578
			0.1346	0.0716
			0.1267	0.0866
			0.1158	0.0736
E	471	474	0.1215	0.0626
			0.1321	0.0761
			0.1238	0.0926
			0.1128	0.0799

Tolerance = ± 1.0 nm.

Figure 2: Spectral Power Distribution

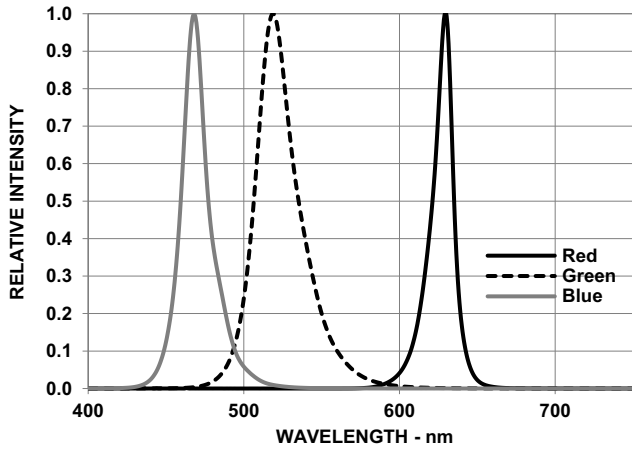

Figure 3: Forward Current vs. Forward Voltage

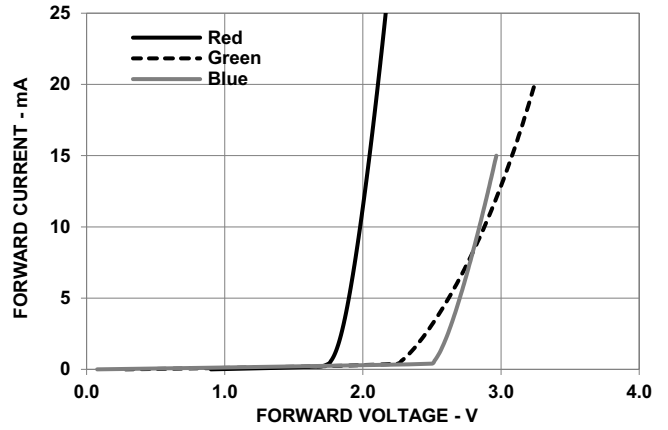

Figure 4: Relative Luminous Intensity vs. Mono Pulse Current

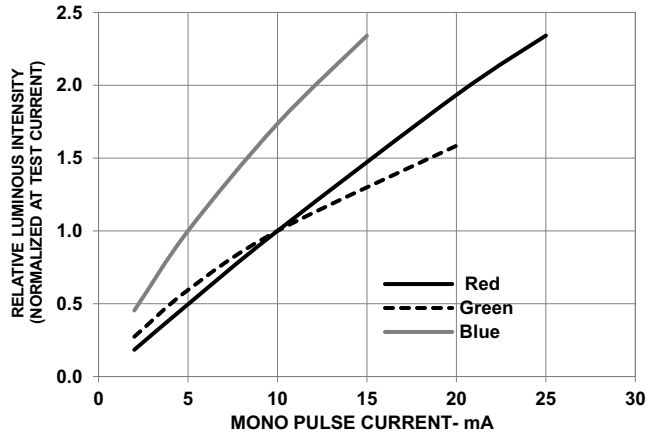

Figure 5: Dominant Wavelength Shift vs. Mono Pulse Current

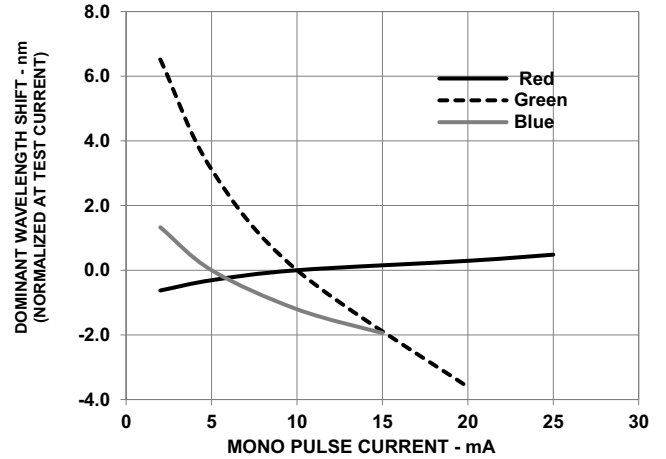

Figure 6: Relative Light Output vs. Junction Temperature

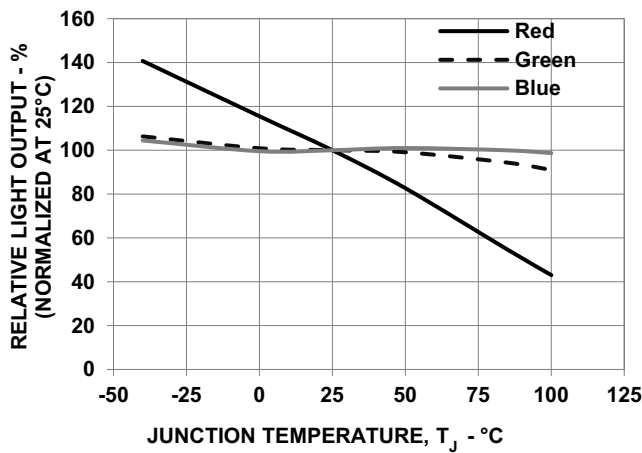

Figure 7: Forward Voltage Shift vs. Junction Temperature

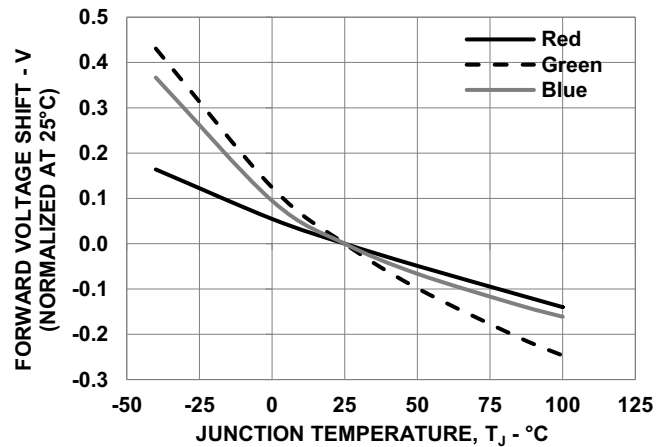

Figure 8: Maximum Forward Current vs. Temperature for Red, Green, and Blue (3 Chips On)

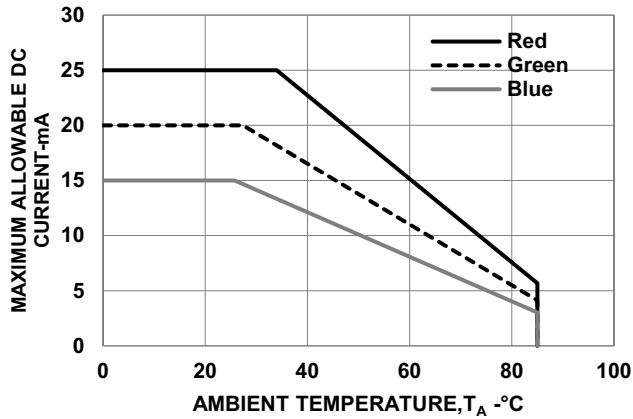
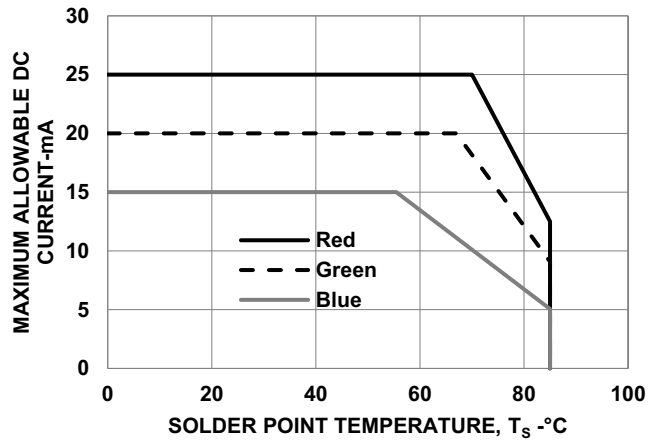

Figure 9: Maximum Forward Current vs. Solder Temperature for Red, Green, and Blue (3 Chips On)



The preceding maximum forward current graphs based on ambient temperature (T_A) are with reference to the thermal resistance R_{θJ-A} in the following table. See [Precautionary Notes](#) for more details.

Condition	Thermal Resistance from LED Junction to Ambient, R _{θJ-A} (°C/W)		
	Red	Green	Blue
3 chips on	1100	1100	1600

Figure 10: Radiation Pattern for X-Axis

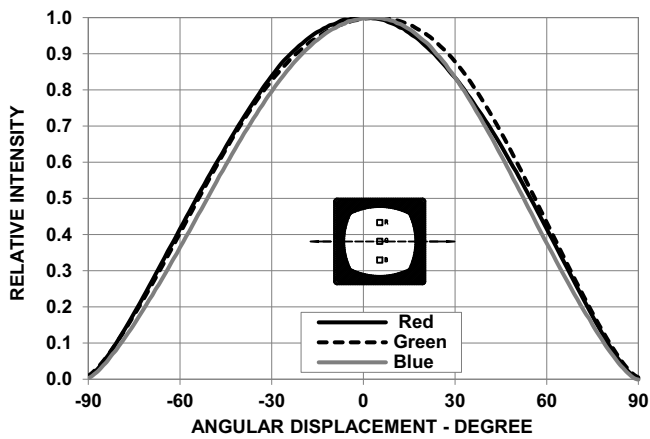

Figure 11: Radiation Pattern for Y-Axis

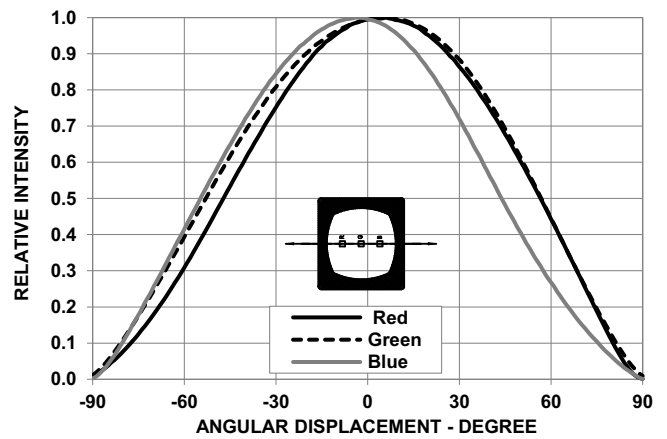
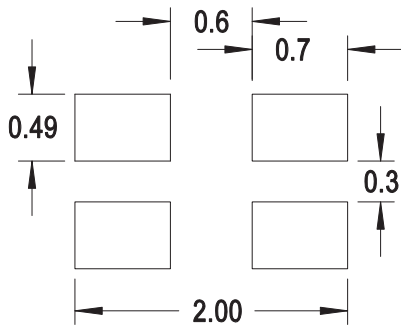
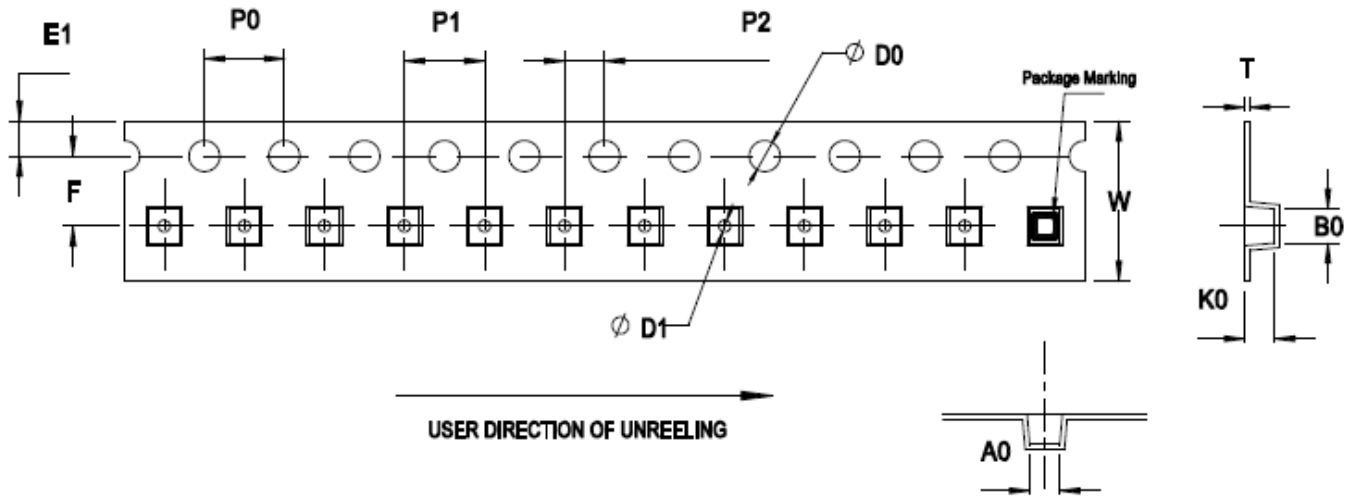

Figure 12: Recommended Soldering Pad Pattern



NOTE: All dimensions are in millimeters (mm).

Figure 13: Carrier Tape Drawing



F	E1	P0	P1	P2	D0	D1	W	A0	K0
3.5 ± 0.1	1.75 ± 0.1	4.0 ± 0.1	4.0 ± 0.1	2.0 ± 0.1	1.50 +0.1/-0	1.0 ± 0.1	8.0 ± 0.2	1.75 ± 0.1	1.75 ± 0.1
B0	T								
1.85 ± 0.1	0.25 ± 0.05								

NOTE:

1. All dimensions are in millimeters (mm).
2. Tolerance is ± 0.20 mm unless otherwise specified.

Figure 14: Reel Drawing

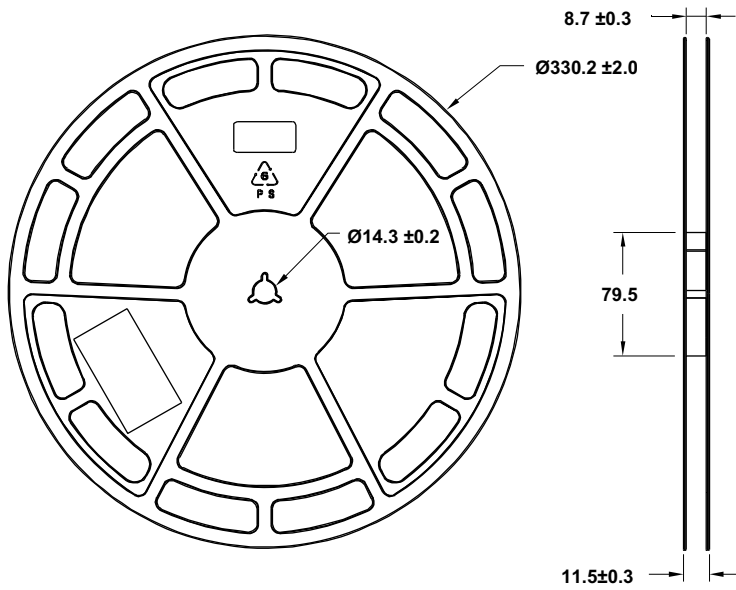

NOTE: All dimensions are in millimeters (mm).

Precautionary Notes

Soldering

- Do not perform reflow soldering more than twice. Observe necessary precautions of handling moisture-sensitive devices as stated in the following section.
- Do not apply any pressure or force on the LED during reflow and after reflow when the LED is still hot.
- Use reflow soldering to solder the LED. Use hand soldering only for rework if unavoidable, but it must be strictly controlled to following conditions:
 - Soldering iron tip temperature = 315°C maximum.
 - Soldering duration = 3 seconds maximum.
 - Number of cycles = 1 only.
 - Power of soldering iron = 50W maximum.
- Do not touch the LED package body with the soldering iron except for the soldering terminals, because it may cause damage to the LED.
- Confirm beforehand whether the functionality and performance of the LED is affected by soldering with hand soldering.

Figure 15: Recommended Lead-Free Reflow Soldering Profile

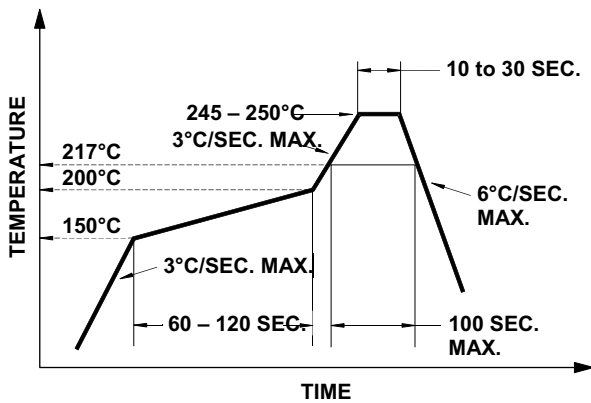
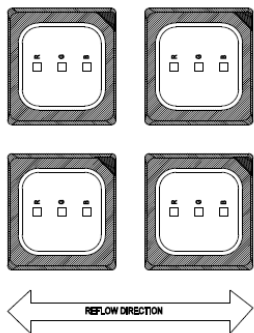

Figure 16: Recommended Board Reflow Direction



Handling Precautions

Special handling precautions must be observed during the assembly of epoxy encapsulated LED products. Failure to comply might lead to damage and premature failure of the LED.

- Do not stack assembled PCBs together. Use an appropriate rack to hold the PCBs.
- For automated pick and place, Broadcom has tested a nozzle size with OD 1.5 mm to work with this LED. However, due to the possibility of variations in other parameters such as pick and place machine maker/model, and other settings of the machine, verify that the selected nozzle will not cause damage to the LED.

Handling of Moisture-Sensitive Devices

This product has a Moisture Sensitive Level 5a rating per JEDEC J-STD-020. Refer to Broadcom Application Note AN5305, *Handling of Moisture Sensitive Surface Mount Devices*, for additional details and a review of proper handling procedures.

Before use:

- An unopened moisture barrier bag (MBB) can be stored at <40°C/90% RH for 12 months. If the actual shelf life has exceeded 12 months and the humidity indicator card (HIC) indicates that baking is not required, it is safe to reflow the LEDs per the original MSL rating.
- Do not open the MBB prior to assembly (for example, for IQC). If unavoidable, the MBB must be properly resealed with fresh desiccant and HIC. The exposed duration must be taken in as floor life.

Control after opening the MBB:

- Read the HIC immediately upon opening of the MBB.
- Keep the LEDs at <30°/60% RH at all times, and complete all high temperature-related processes, including soldering, curing or rework within 24 hours.

Control for unfinished reel:

Store unused LEDs in a sealed MBB with desiccant or a desiccator at <5% RH.

Control of assembled boards:

If the PCB soldered with the LEDs is to be subjected to other high-temperature processes, store the PCB in a sealed MBB with desiccant or desiccator at <5% RH to ensure that all LEDs have not exceeded their floor life of 24 hours.

Baking is required if the following conditions exist:

- The HIC indicator indicates a change in color for 10% and 5%, as stated on the HIC.
- The LEDs are exposed to conditions of >30°C/60% RH at any time.
- The LEDs' floor life exceeded 24 hours.

The recommended baking condition is: 65°C ± 5°C for 24 hours.

Baking can only be done once.

Storage:

The soldering terminals of these Broadcom LEDs are silver plated. If the LEDs are exposed in ambient environments for too long, the silver plating might be oxidized, thus affecting its solderability performance. As such, keep unused LEDs in a sealed MBB with desiccant or in a desiccator at <5% RH.

Application Precautions

- The drive current of the LED must not exceed the maximum allowable limit across temperature as stated in the data sheet. Constant current driving is recommended to ensure consistent performance.
- The circuit design must cater to the entire range of forward voltage (V_F) of the LEDs to ensure the intended drive current can always be achieved.
- The LED exhibits slightly different characteristics at different drive currents, which may result in a larger variation of performance (such as intensity, wavelength, and forward voltage). Set the application current as close as possible to the test current to minimize these variations.
- The LED is not intended for reverse bias. Use other appropriate components for such purposes. When driving the LED in matrix form, ensure that the reverse bias voltage does not exceed the allowable limit of the LED.
- As the actual application might not be exactly similar to the test conditions, verify that the LED will not be damaged by prolonged exposure in the intended environment.

- Avoid rapid changes in ambient temperature, especially in high-humidity environments, because they cause condensation on the LED.
- If the LED is intended to be used in a harsh or an outdoor environment, protect the LED against damages caused by rain water, water, dust, oil, corrosive gases, external mechanical stresses, and so on.

Thermal Management

The optical, electrical, and reliability characteristics of the LED are affected by temperature. Keep the junction temperature (T_J) of the LED below the allowable limit at all times. T_J can be calculated as follows:

$$T_J = T_A + R_{\theta J-A} \times I_F \times V_{Fmax}$$

where:

T_A = Ambient temperature (°C)

$R_{\theta J-A}$ = Thermal resistance from LED junction to ambient (°C/W)

I_F = Forward current (A)

V_{Fmax} = Maximum forward voltage (V)

The complication of using this formula lies in T_A and $R_{\theta J-A}$. Actual T_A is sometimes subjective and hard to determine. $R_{\theta J-A}$ varies from system to system depending on design and is usually not known.

Another way of calculating T_J is by using the solder point temperature, T_S as follows:

$$T_J = T_S + R_{\theta J-S} \times I_F \times V_{Fmax}$$

where:

T_S = LED solder point temperature as shown in the following figure (°C)

$R_{\theta J-S}$ = Thermal resistance from junction to solder point (°C/W)

I_F = Forward current (A)

V_{Fmax} = Maximum forward voltage (V)

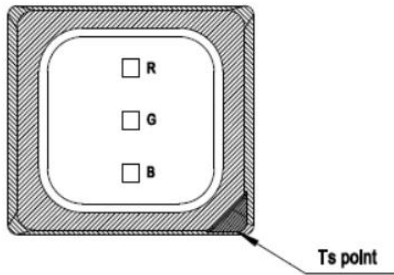
Figure 17: Solder Point Temperature on PCB

T_S can be easily measured by mounting a thermocouple on the soldering joint as shown in preceding figure, while $R_{\theta J-S}$ is provided in the data sheet. Verify the T_S of the LED in the final product to ensure that the LEDs are operating within all maximum ratings stated in the data sheet.

Eye Safety Precautions

LEDs may pose optical hazards when in operation. Do not look directly at operating LEDs because it might be harmful to the eyes. For safety reasons, use appropriate shielding or personal protective equipment.

Disclaimer

Broadcom's products and software are not specifically designed, manufactured, or authorized for sale as parts, components, or assemblies for the planning, construction, maintenance, or direct operation of a nuclear facility or for use in medical devices or applications. The customer is solely responsible, and waives all rights to make claims against Broadcom or its suppliers, for all loss, damage, expense, or liability in connection with such use.

Broadcom, the pulse logo, Connecting everything, Avago Technologies, Avago, and the A logo are among the trademarks of Broadcom and/or its affiliates in the United States, certain other countries, and/or the EU.

Copyright © 2021 Broadcom. All Rights Reserved.

The term "Broadcom" refers to Broadcom Inc. and/or its subsidiaries. For more information, please visit www.broadcom.com.

Broadcom reserves the right to make changes without further notice to any products or data herein to improve reliability, function, or design. Information furnished by Broadcom is believed to be accurate and reliable. However, Broadcom does not assume any liability arising out of the application or use of this information, nor the application or use of any product or circuit described herein, neither does it convey any license under its patent rights nor the rights of others.

