

l) tails to fit in PC-board layout

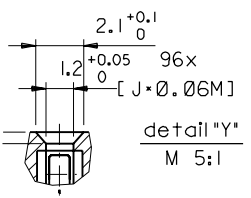
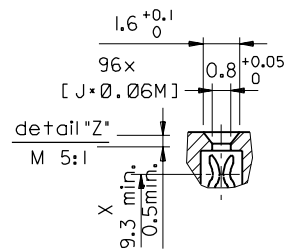
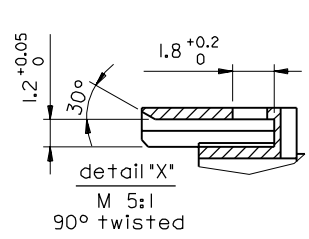
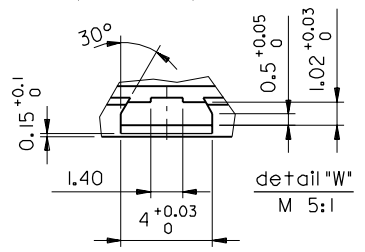
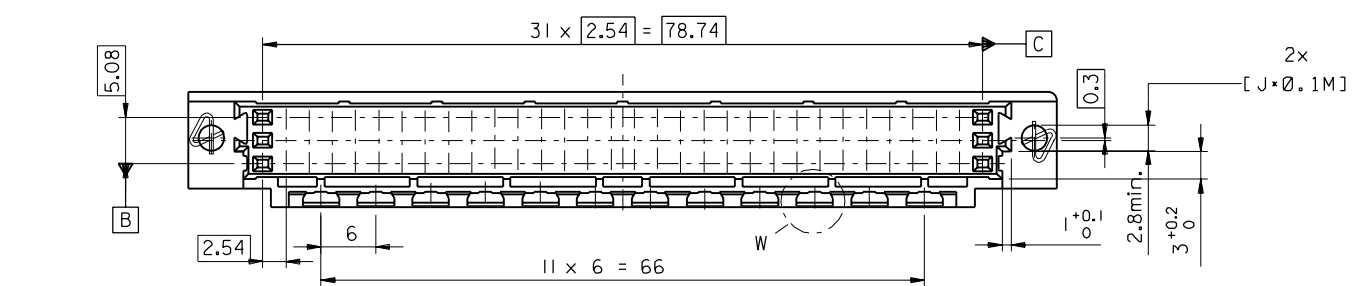
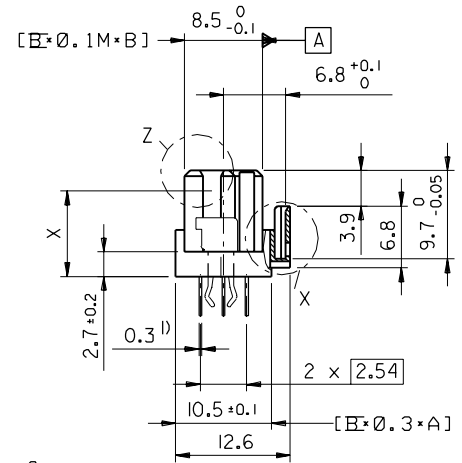
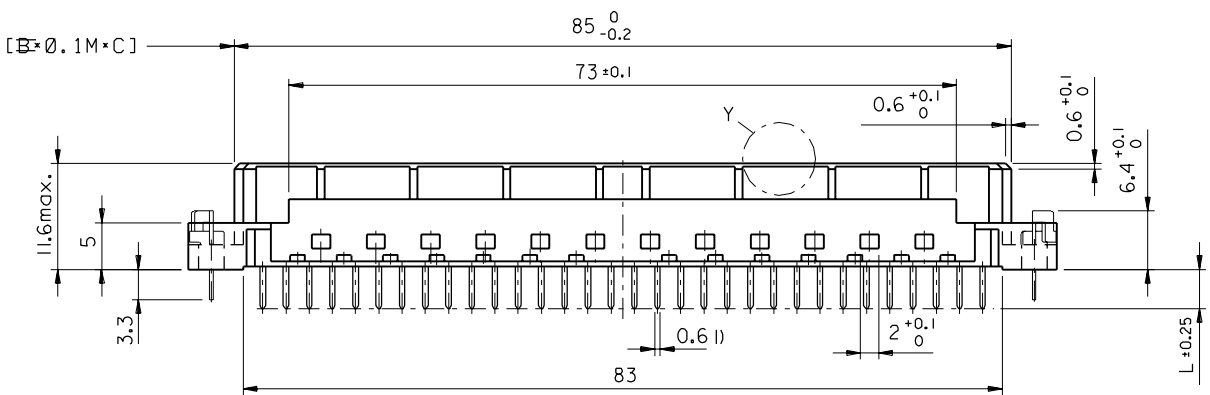

FIRST ANGLE PROJECTION

REVISE ONLY ON CAD SYSTEM

ECN MG1998-2583	Schraube, Lochbild	97-09-17 KN
B	LTR	REVISIONS
FOR PREVIOUS REVISIONS SEE MRI LIST		
UNLESS OTHERWISE SPECIFIED TOLERANCES: ANGULAR ±2°		
3 PLACE ±	±	±
2 PLACE ±	±	±
1 PLACE ±	±	±
DRAFT WHERE APPLICABLE MUST REMAIN WITHIN DIMENSIONS		
DESIGN DIMENSION	<input checked="" type="checkbox"/> MM	<input type="checkbox"/> IN.
EQUIVALENT DIMENSION	<input type="checkbox"/> MM	<input type="checkbox"/> IN.
IF TWO DIMENSIONS ARE SHOWN THE UPPER IS THE DESIGN DIMENSION, LOWER IS SECONDARY		

DRWG BY	KN	SIGN
CHK'D BY	Ca	SIGN
APP'D BY	JB	SIGN
SCALE	2:1	

CAD/CAM PROJECT NAME	85042000	812
THIS DRAWING CONTAINS INFORMATION THAT IS PROPRIETARY TO MOLEX INC. & SHOULD NOT BE USED WITHOUT WRITTEN PERMISSION		
TITLE		
96 pos. female connector		
DIN 41612 style C, + clip		
with coding, dimensions		
MOLEX MOLEX EUROPE		SHEET NO. DATE
		2 of 2 96/04/30
PART NO.	DWG NO.	SIZE
SDA-85042-0001		B

