

Features:

- Frequency Range: 17 – 43 GHz
- P1dB: 21 dBm
- Psat: 22 dBm
- Gain: 22 dB
- Vdd =5 V (3 V to 5 V)
- Ids = 200 mA (150mA to 300mA)
- Input and Output Fully Matched to 50 Ω
- 2x and 3x Frequency multiplier applications

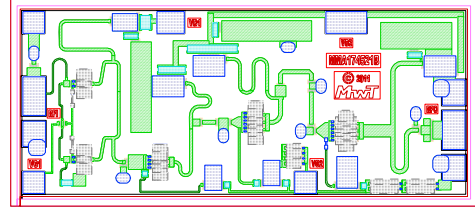

Die size: 1720 x 760 x 50 um
69 x 30 x 2 mil

Applications:

- Communication systems
- Microwave instrumentations

Description:

The MMA-174321 is a broadband GaAs MMIC general purpose gain block for 0.1-Watt maximum output power and high gain over full 17 to 43GHz frequency range. This amplifier is able to use as 2x and 3x Frequency multipliers when biased under class-B condition for the first stage.

Electrical Specifications: *Vds=5V, Vgs=-0.7V, Ids=200mA, Ta=25 °C Z0=50 ohm*

Parameter	Units	Typical Data
Frequency Range	GHz	17-43
Gain (Typ / Min)	dB	22 / 20
Gain Flatness (Typ / Max)	+/-dB	2.0 / 2.5
Input RL(Typ/Max)	dB	8/6
Output RL(Typ/Max)	dB	8/6
Output P1dB(Typ/Min)	dBm	21/19.5
Output IP3 ⁽¹⁾	dBm	26
Output Psat(Typ/Min)	dBm	22/20.5
Operating Current at P1dB (Typ/Max)	mA	240 / 250
Thermal Resistance	°C /W	30

(1) Output IP3 is measured with two tones at output power of 5 dBm/tone separated by 20 MHz.

Typical RF Performance: $V_{ds}=5V$, $V_{gs}=-0.7V$, $I_{ds}=200mA$, $Z_0=50\text{ ohm}$, $T_a=25^\circ C$

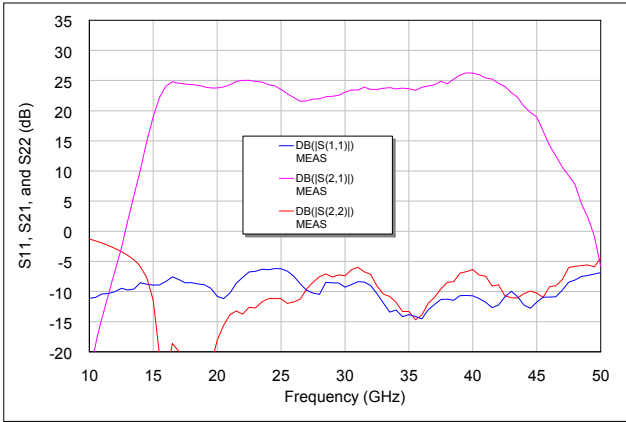

S11[dB], S21[dB], and S22[dB] vs. Frequency

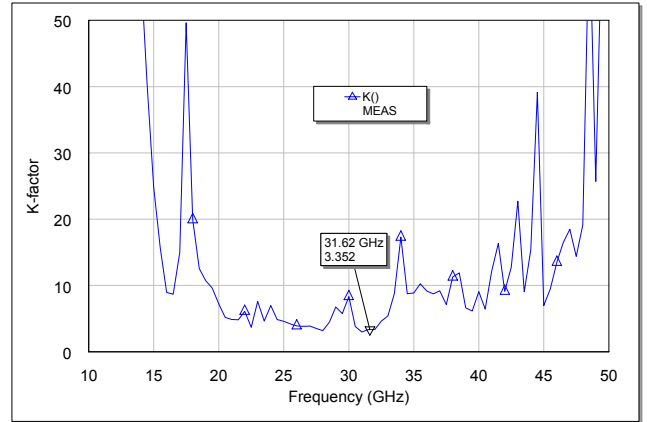

K-factor vs. Frequency

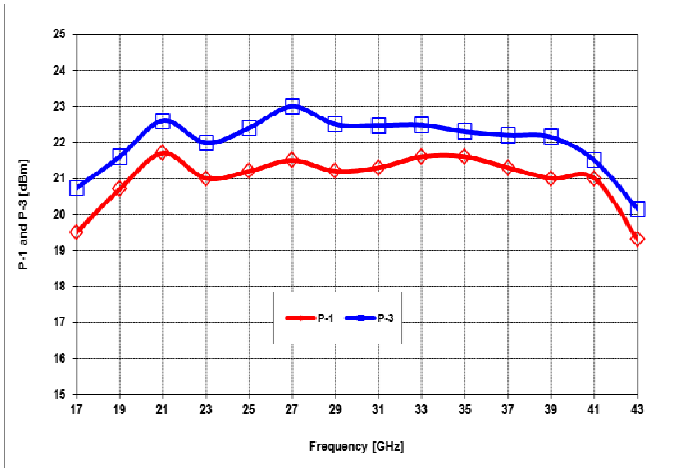

P-1 and Psat vs. Frequency

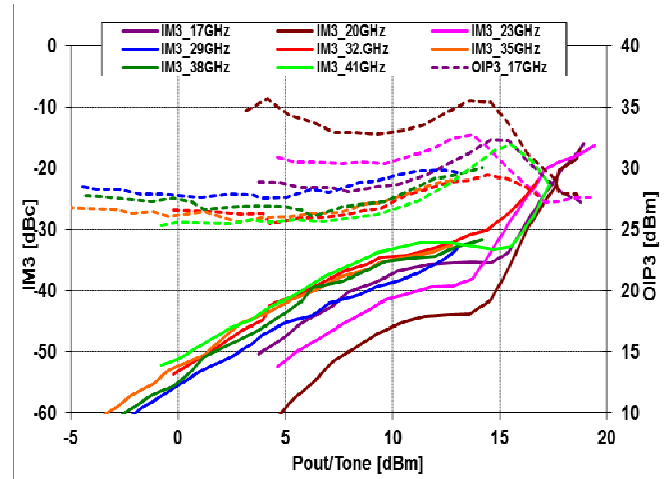

IM3 level [dBc] vs. Input power [dBm/tonne]

Frequency 2x and 3x multiplier Data:

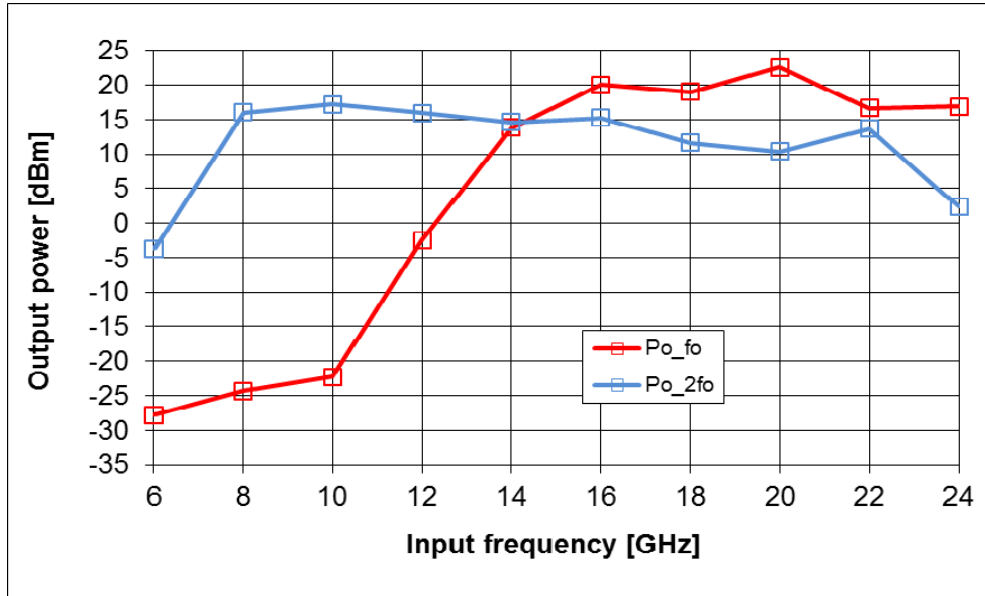

Measured 2x multiplier data: Pin=9dBm, Vd1=5V, Vd2=5V, Vg1=-1.4V, Vg2=-0.7V, Id1=1mA, and Id2=163mA

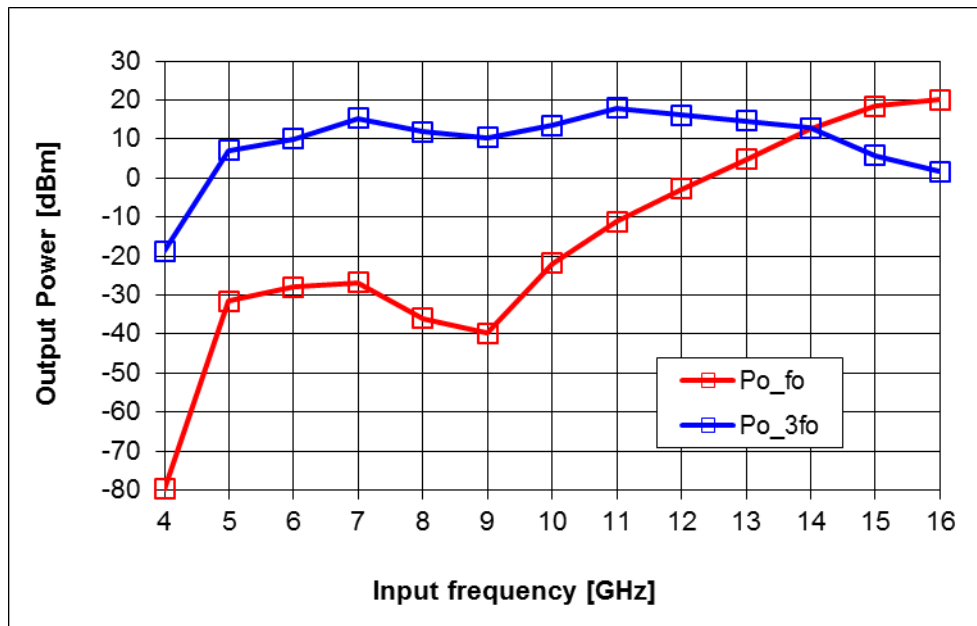

Measured 3x multiplier data: Pin=9dBm, Vd1=1V, Vd2=5V, Vg1=-0.75V, Vg2=-0.75V, Id1=21mA, and Id2=144mA

Applications

The **MMA-174321** MMIC general purpose amplifier is designed for use as a gain stage amplifier in microwave transmitters. It is ideally suited for 17 to 43GHz band applications requiring a flat gain response and excellent power performance. This amplifier is provided as a bare die format in a Gel-pak.

Biassing and Operation

The recommended bias conditions for best performance for the **MMA-174321** are $V_{DD} = 5.0V$, $I_{dsq} = 200mA$. Performance improvements are possible depending on applications. The drain bias voltage range is 3 to 6V and the quiescent drain current biasing range is 150mA to 250mA. V_{g1} is connected to first stages of gate, and V_{g2} is connected to following three stages of gates. Muting can be accomplished by setting V_{g1} and V_{g2} to the pinched-off voltage ($V_p = -2V$). The gate voltages (V_{g1} and V_{g2}) should be applied prior to the drain voltages (V_{d1} and V_{d2}) during power up and removed after the drain voltages during power down. The RF input port is connected internally to the 50Ω load for ESD protection purpose; therefore, an input decoupling capacitor is needed if the preceding output stage has DC present. The RF output is DC decoupled internally. Typical DC supply connection with bi-passing capacitors for the **MMA-174321** is shown in following pages.

Frequency x2 and x3 Multiplier Applications:

MMA-174321 is able to use as a frequency x2 multiplier when biased under $V_{d1}=5V$, $V_{d2}=5V$, $V_{g1}=-1.4V$, $V_{g2}=-0.7V$, $I_{d1}=1mA$, and $I_{d2}=163mA$. Optimum input RF power level is +9dBm. Typical measured data is shown in previous page. **MMA-174321** is also able to use as a frequency x3 multiplier when biased under $V_{d1}=1V$, $V_{d2}=5V$, $V_{g1}=-0.75V$, $V_{g2}=-0.75V$, $I_{d1}=21mA$, and $I_{d2}=144mA$. Optimum input RF power level is +9dBm. Typical measured data is shown in previous page.

Assembly Techniques

GaAs MMICs are ESD sensitive. ESD preventive measures must be employed in all aspects of storage, handling, and assembly. MMIC ESD precautions, handling considerations, die attach and bonding methods are critical factors in successful GaAs MMIC performance and reliability.

Absolute Maximum Ratings: ($T_a = 25\text{ }^\circ\text{C}$)*

SYMBOL	PARAMETERS	UNITS	Min.	Max.
V_{d1}, V_{d2}	Drain-Supply Voltage	V		5.4
V_{g1}	Optional Gate supply Voltage	V	-2	0.5
V_{g2}	Optional Gate supply Voltage	V	-2	0.5
I_{dd}	Total Drain Supply Current	mA		400
$P_{in\ max}$	RF Input Power	dBm		21
T_{oper}	Operating Temperature	$^\circ\text{C}$		-40 to +85
T_{ch}	Channel Temperature	$^\circ\text{C}$		+150
T_{stg}	Storage Temperature	$^\circ\text{C}$		-55 to +165
T_{max}	Max. Assembly Temp (60 sec max)	$^\circ\text{C}$		+300

*Operation of this device above any one of these parameters may cause permanent damage.

Mechanical Information: *Top view*

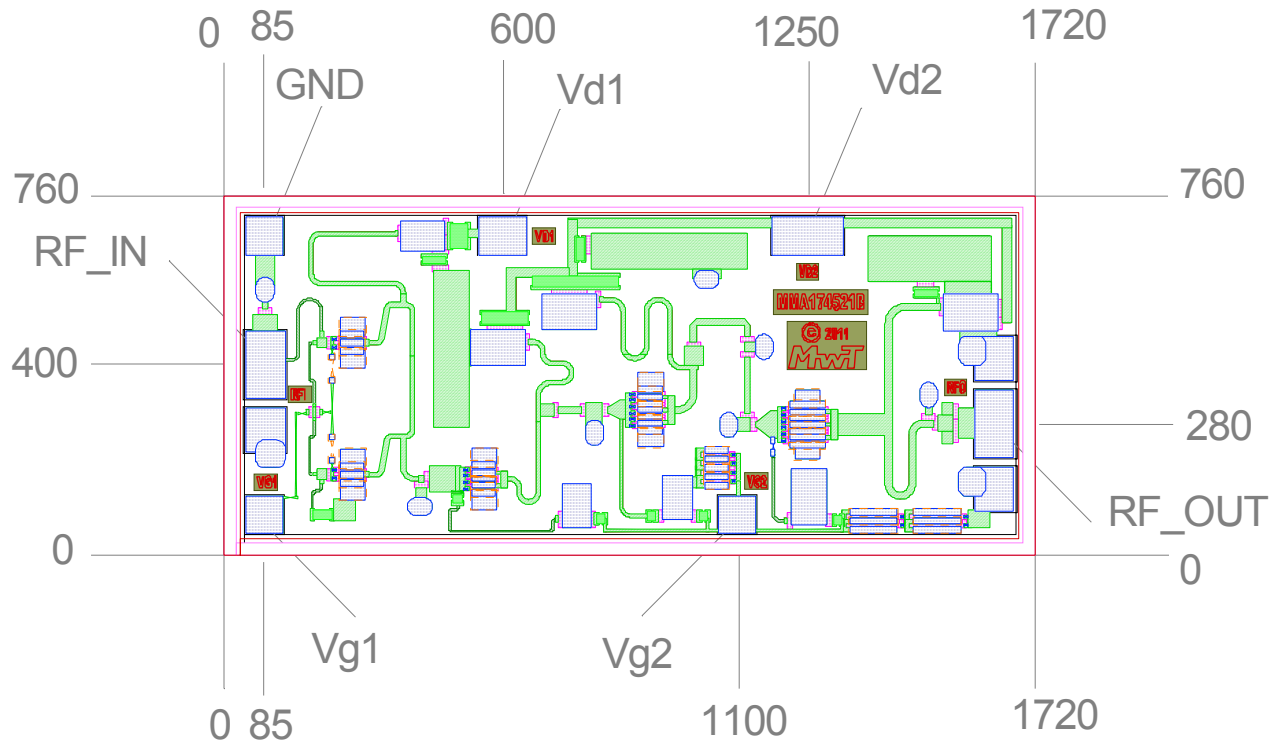

Units are in um.

Application Circuit:

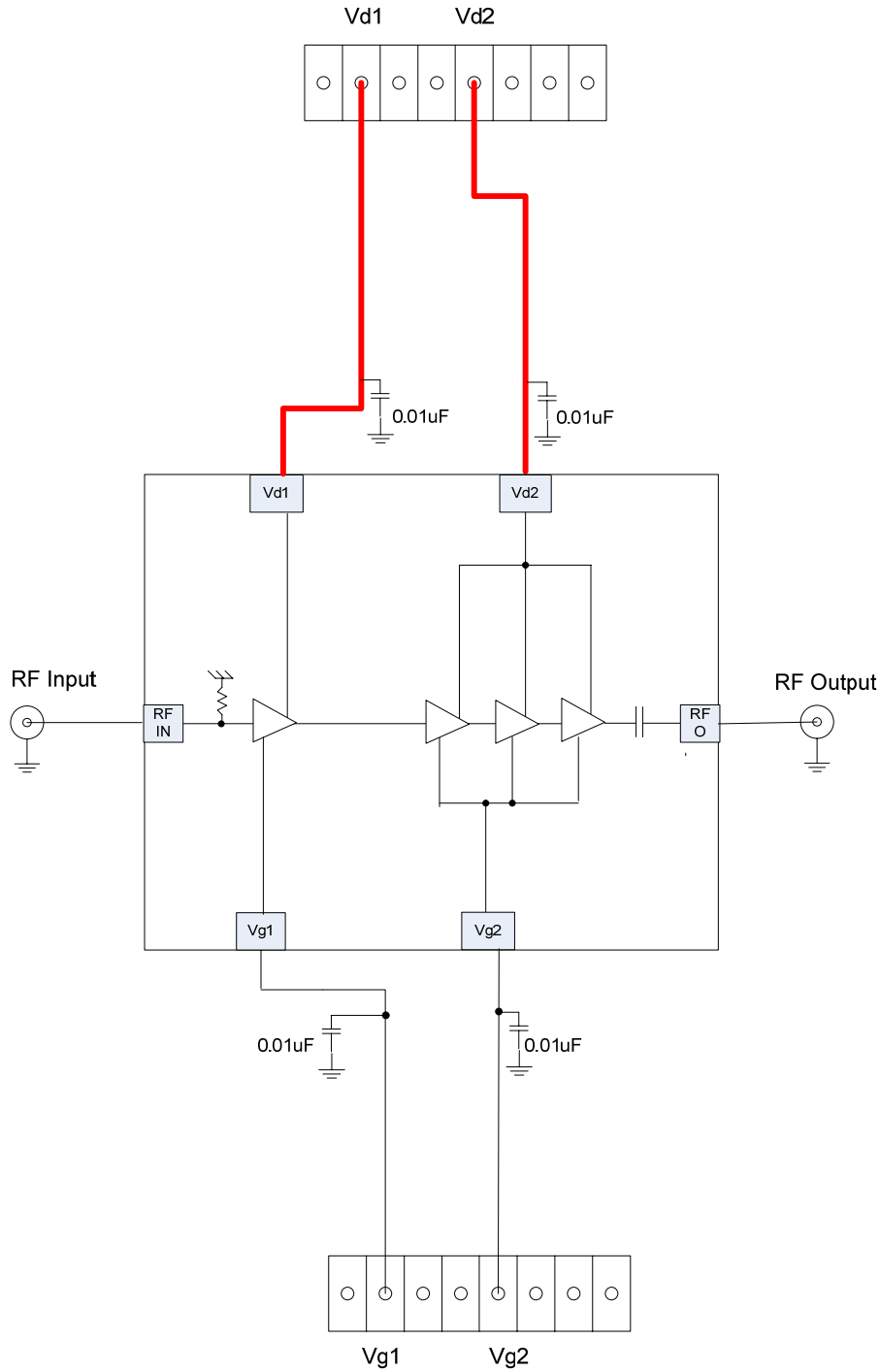

Assembly example:

