

10 9 8 7 6 5 4 3 2 1

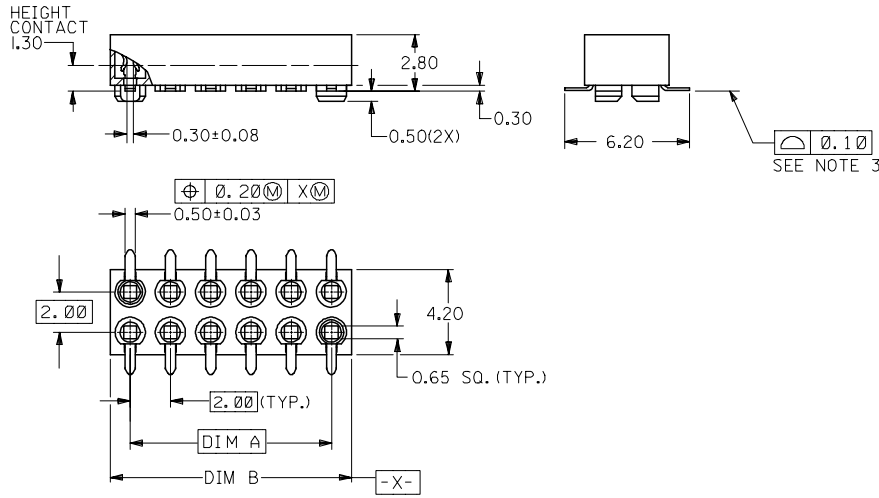

**PART NO. LEGEND**

- 87263 - \* \* \* \*
- CIRCUIT SIZE
  - PLATING
  - TIN/LEAD OPTION
    - 0 - 0.38um MIN. GOLD
    - 2 - 0.76um MIN. GOLD
    - 4 - (0.13-0.38)um GOLD FLASH
  - TIN OPTION
    - 3 - 0.38um MIN. GOLD
    - 5 - 0.76um MIN. GOLD
    - 6 - (0.13-0.38)um GOLD FLASH
  - PACKAGING
    - 0 - W/CAP IN TUBE (SEE SHEET 2)
    - 2 - W/O CAP IN TUBE (SEE SHEET 2)
    - 9 - W/CAP IN TAPE & REEL (SEE SHEET 3)

CKT. SIZE	DIM. A	DIM. B
4	2.00	4.00
6	4.00	6.00
8	6.00	8.00
10	8.00	10.00
12	10.00	12.00
14	12.00	14.00
16	14.00	16.00
18	16.00	18.00
20	18.00	20.00
22	20.00	22.00
24	22.00	24.00
26	24.00	26.00
28	26.00	28.00
30	28.00	30.00
32	30.00	32.00
34	32.00	34.00
36	34.00	36.00
38	36.00	38.00
40	38.00	40.00
42	40.00	42.00
44	42.00	44.00

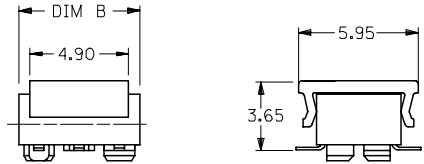

PARTS TO BE PACK WITH CAP (12 CKT SHOWN)

**NOTES:**

- FOR ILLUSTRATION PURPOSES, DRAWING SHOWS PART WITH 12 CIRCUIT SIZE.
- PLATING  
POST-PLATING - SELECTIVE GOLD (SEE LEGEND) AT CONTACT AREA, AND SELECTIVE TIN/LEAD OR TIN AT SOLDER AREA, BOTH OVER NICKEL OVERALL.
- CO-PLANARITY OF P.C TAIL TO BE MEASURED BY RESTING THE PART ON A FLAT GAGE SURFACE.
- PRODUCT SPECIFICATION PS-87263 APPLIES.
- CAP : HIGH TEMPERATURE THERMOPLASTIC, UL RATED 94V-0, SUITABLE FOR SURFACE-MOUNT SOLDERING PROCESS. COLOR BLACK
- POSITION OF CAP TO BE CENTRAL WITH RESPECT TO DIMENSION 'A'
- CONTACT FACTORY FOR DETAILS ON THIS PART NO.

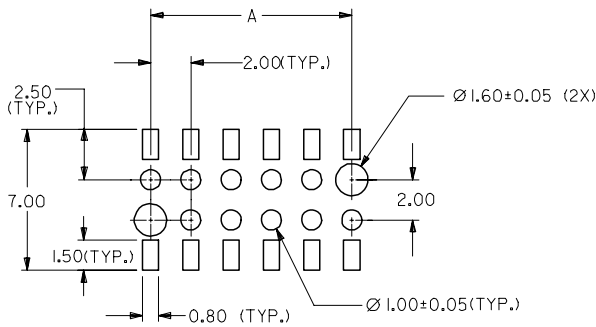

RECOMMENDED SOLDER PAD DESIGN

ADD ASSY P/N FOR /LF EC NO: S2005-0013 DRAWN:SEE CHKD:ATSEE APPR:SKTOH	2004/07/28 2004/07/28 2004/07/30	QUALITY SYMBOLS ▽=0 ▽=0	GENERAL TOLERANCES (UNLESS SPECIFIED)		DIMENSION STYLE MM ONLY		SCALE NTS	DESIGN UNITS METRIC	THIRD ANGLE PROJECTION		
			mm	INCH	DRAWN BY JDK	DATE 1991/01/11	TITLE MGRID B/ENTRY RECEPT. 2.80MM HT. W/LOC. PEGS WITH CAP, SMT				
REV	DESCRIPTION	DRAFT WHERE APPLICABLE MUST REMAIN WITHIN DIMENSIONS	4 PLACES	± ---	± ---	CHECKED BY MLA1	DATE 1991/01/11	MOLEX INCORPORATED			
			3 PLACES	± ---	± ---	APPROVED BY RWONG	DATE 1991/01/11				
			2 PLACES	± 0.20	± ---	DOCUMENT NO. SD-87263-***2*		SHEET NO. 1 OF 3			
			1 PLACE	± ---	± ---	THIS DRAWING CONTAINS INFORMATION THAT IS PROPRIETARY TO MOLEX INCORPORATED AND SHOULD NOT BE USED WITHOUT WRITTEN PERMISSION					

9 8 7 6 5 4 3 2 1

10 9 8 7 6 5 4 3 2 1

F

E

D

C

B

A

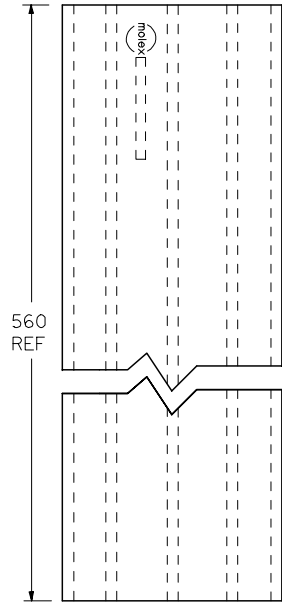

P/N 87263-\*\*-2\*

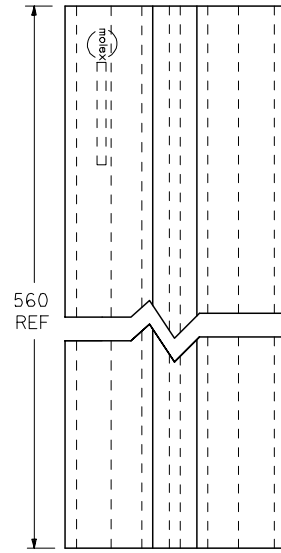

P/N 87263-\*\*-0\*

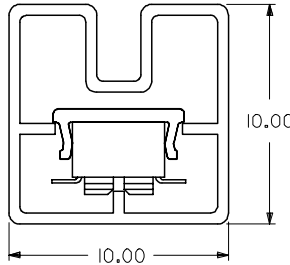
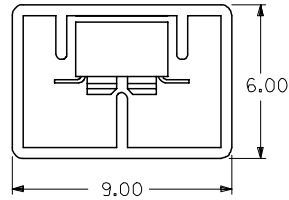

CKT. SIZE	PART NO. FOR PARTS WITHOUT CAP	△ PART NO. FOR PARTS WITH CAP
4	87263-042*	87263-040*
6	87263-062*	87263-060*
8	87263-082*	87263-080*
10	87263-102*	87263-100*
12	87263-122*	87263-120*
14	87263-142*	87263-140*
16	87263-162*	87263-160*
18	87263-182*	87263-180*
20	87263-202*	87263-200*
22	87263-222*	87263-220*
24	87263-242*	87263-240*
26	87263-262*	87263-260*
28	87263-282*	87263-280*
30	87263-302*	87263-300*
32	87263-322*	87263-320*
34	87263-342*	87263-340*
36	87263-362*	87263-360*
38	87263-382*	87263-380*
40	87263-402*	87263-400*
42	87263-422*	87263-420*
44	△ 87263-442*	87263-440*

F

E

D

C

B

A

ADD ASSY P/N FOR /LF	REV	DESCRIPTION
EC NO: S2005-0013		
DRWN:KSEE		2004/07/28
CHKD:ATSEE		2004/07/28
APPR:SKTOH		2004/07/30

QUALITY SYMBOLS	DESCRIPTION
▽=0	
▽C=0	

GENERAL TOLERANCES (UNLESS SPECIFIED)	
	mm INCH
4 PLACES	± --- ± ---
3 PLACES	± --- ± ---
2 PLACES	± 0.20 ± ---
1 PLACE	± --- ± ---
ANGULAR ± 3 °	
DRAFT WHERE APPLICABLE MUST REMAIN WITHIN DIMENSIONS	

DIMENSION STYLE	
MM ONLY	
DRAWN BY	DATE
GOH	1995/03/15
CHECKED BY	DATE
JAMES	1995/04/03
APPROVED BY	DATE
GMS	1995/04/03
MATERIAL NO.	
SEE TABLE	
SIZE	A3

SCALE	DESIGN UNITS	THIRD ANGLE PROJECTION
NTS	METRIC	
TITLE		
MGRID B/ENTRY RECEPT. 2.80MM HT. W/LOC. PEGS WITH CAP, SMT		
MOLEX INCORPORATED		
DOCUMENT NO.		SHEET NO.
SD-87263-**-2*		2 OF 3
THIS DRAWING CONTAINS INFORMATION THAT IS PROPRIETARY TO MOLEX INCORPORATED AND SHOULD NOT BE USED WITHOUT WRITTEN PERMISSION		

9 8 7 6 5 4 3 2 1

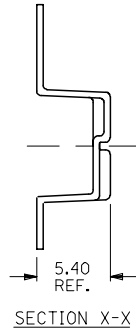
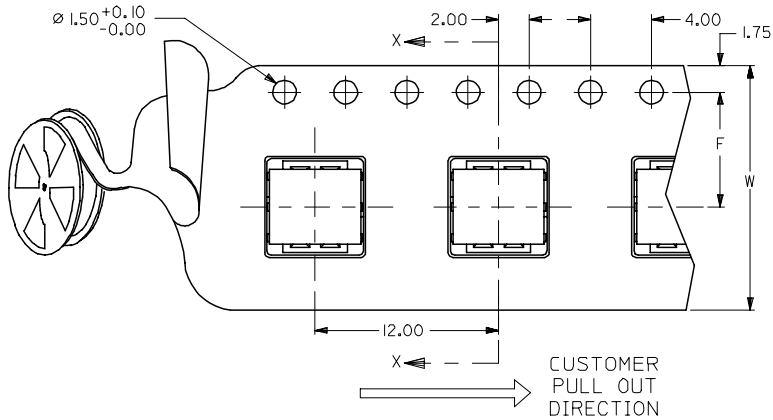

PART NO. 87263-\*\*\*9\* (CKTS 04 TO 14)  
SINGLE SPROCKET HOLE T/REEL - TYPE A

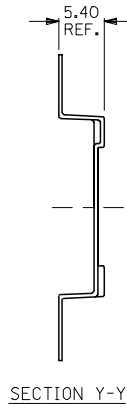
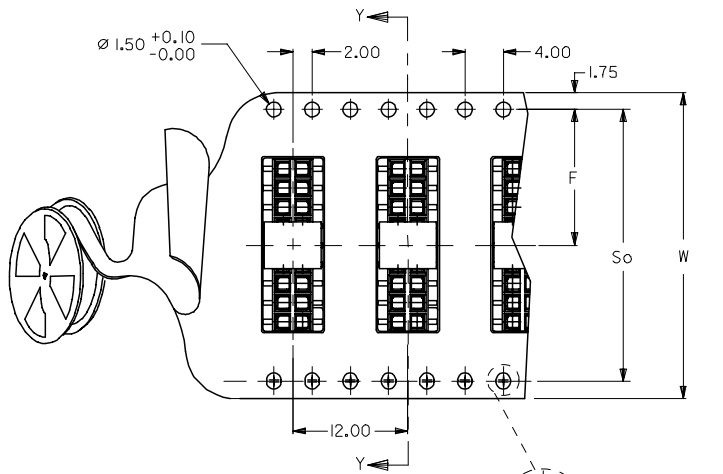

PART NO. 87263-\*\*\*9\* (CKTS 16 TO 40)  
DOUBLE SPROCKET HOLE T/REEL - TYPE B

△ PART NO. FOR PARTS IN T/REEL	CKT. SIZE	F	So	W	T/REEL TYPE
87263-049*	4	11.5	-	24	A
87263-069*	6	11.5	-	24	
87263-089*	8	11.5	-	24	
87263-109*	10	11.5	-	24	
87263-129*	12	11.5	-	24	
87263-149*	14	11.5	-	24	B
87263-169*	16	11.5	-	24	
87263-189*	18	14.2	28.4	32	
87263-209*	20	20.2	40.4	44	
87263-229*	22	-	-	-	
87263-249*	24	20.2	40.4	44	
87263-269*	26	20.2	40.4	44	
87263-289*	28	20.2	40.4	44	
87263-309*	30	20.2	40.4	44	
87263-329*	32	-	-	-	
87263-349*	34	-	-	-	
87263-369*	36	-	-	-	
87263-389*	38	-	-	-	
87263-409*	40	-	-	-	

NOTES: (CONTINUED FROM PG 1)  
8. NUMBER OF CONNECTORS : 1000 PCS/REEL MAX.  
9. TAPE & REEL PER EIA STANDARD.

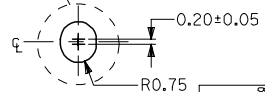

ADD ASSY P/N FOR L/F
EC NO: S2005-0013
DRWN:KSEE 2004/07/28
CHKD:ATSEE 2004/07/28
APPR:SKTOH 2004/07/30
REV

QUALITY SYMBOLS
▽=0
▽C=0

GENERAL TOLERANCES (UNLESS SPECIFIED)
4 PLACES ± --- ± ---
3 PLACES ± --- ± ---
2 PLACES ± 0.20 ± ---
1 PLACE ± --- ± ---
ANGULAR ± 3 °
DRAFT WHERE APPLICABLE MUST REMAIN WITHIN DIMENSIONS

DIMENSION STYLE
MM ONLY
DRAWN BY DATE
GOH 1995/03/15
CHECKED BY DATE
JAMES 1995/04/03
APPROVED BY DATE
GMS 1995/04/03
MATERIAL NO.
SEE TABLE

SCALE
NTS
DESIGN UNITS
METRIC
THIRD ANGLE PROJECTION
TITLE
MGRID B/ENTRY RECEPT. 2.80MM HT. W/LOC. PEGS WITH CAP, SMT
MOLEX INCORPORATED
DOCUMENT NO.
SD-87263-***2*
SHEET NO.
3 OF 3