

SN5490A, SN5492A, SN5493A, SN54LS90, SN54LS92, SN54LS93 SN7490A, SN7492A, SN7493A, SN74LS90, SN74LS92, SN74LS93 DECADE, DIVIDE-BY-TWELVE AND BINARY COUNTERS

SDLS940A - MARCH 1974 - REVISED MARCH 1988

'90A, 'LS90 . . . Decade Counters

'92A, 'LS92 . . . Divide By-Twelve Counters

'93A, 'LS93 . . . 4-Bit Binary Counters

TYPES	TYPICAL POWER DISSIPATION
'90A	145 mW
'92A, '93A	130 mW
'LS90, 'LS92, 'LS93	45 mW

description

Each of these monolithic counters contains four master-slave flip-flops and additional gating to provide a divide-by-two counter and a three-stage binary counter for which the count cycle length is divide-by-five for the '90A and 'LS90, divide-by-six for the '92A and 'LS92, and the divide-by-eight for the '93A and 'LS93.

All of these counters have a gated zero reset and the '90A and 'LS90 also have gated set-to-nine inputs for use in BCD nine's complement applications.

To use their maximum count length (decade, divide-by-twelve, or four-bit binary) of these counters, the CKB input is connected to the Q_A output. The input count pulses are applied to CKA input and the outputs are as described in the appropriate function table. A symmetrical divide-by-ten count can be obtained from the '90A or 'LS90 counters by connecting the Q_D output to the CKA input and applying the input count to the CKB input which gives a divide-by-ten square wave at output Q_A .

SN5490A, SN54LS90 . . . J OR W PACKAGE
SN7490A . . . N PACKAGE
SN74LS90 . . . D OR N PACKAGE

(TOP VIEW)

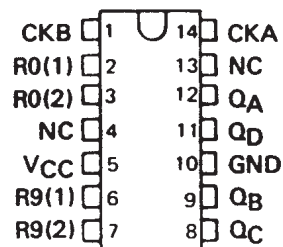

SN5492A, SN54LS92 . . . J OR W PACKAGE
SN7492A . . . N PACKAGE
SN74LS92 . . . D OR N PACKAGE

(TOP VIEW)

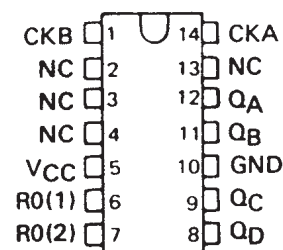

SN5493A, SN54LS93 . . . J OR W PACKAGE
SN7493 . . . N PACKAGE
SN74LS93 . . . D OR N PACKAGE

(TOP VIEW)

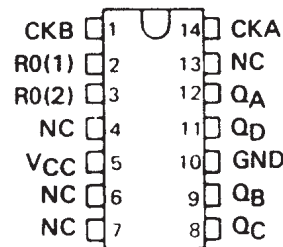

SN5490A, SN5492A, SN5493A, SN54LS90, SN54LS92, SN54LS93
 SN7490A, SN7492A, SN7493A, SN74LS90, SN74LS92, SN74LS93
 DECADE, DIVIDE-BY-TWELVE AND BINARY COUNTERS

SDLS940A – MARCH 1974 – REVISED MARCH 1988

logic symbols†



†These symbols are in accordance with ANSI/IEEE Std. 91-1984 and IEC Publication 617-12.

SN5490A, SN5492A, SN5493A, SN54LS90, SN54LS92, SN54LS93
 SN7490A, SN7492A, SN7493A, SN74LS90, SN74LS92, SN74LS93
 DECADE, DIVIDE-BY-TWELVE AND BINARY COUNTERS

SDLS940A - MARCH 1974 - REVISED MARCH 1988

'90A, 'LS90
 BCD COUNT SEQUENCE
 (See Note A)

COUNT	OUTPUT			
	Q _D	Q _C	Q _B	Q _A
0	L	L	L	L
1	L	L	L	H
2	L	L	H	L
3	L	L	H	H
4	L	H	L	L
5	L	H	L	H
6	L	H	H	L
7	L	H	H	H
8	H	L	L	L
9	H	L	L	H

'90A, 'LS90
 BI-QUINARY (5-2)
 (See Note B)

COUNT	OUTPUT			
	Q _A	Q _D	Q _C	Q _B
0	L	L	L	L
1	L	L	L	H
2	L	L	H	L
3	L	L	H	H
4	L	H	L	L
5	H	L	L	L
6	H	L	L	H
7	H	L	H	L
8	H	L	H	H
9	H	H	L	L

'92A, 'LS92
 COUNT SEQUENCE
 (See Note C)

COUNT	OUTPUT			
	Q _D	Q _C	Q _B	Q _A
0	L	L	L	L
1	L	L	L	H
2	L	L	H	L
3	L	L	H	H
4	L	H	L	L
5	L	H	L	H
6	H	L	L	L
7	H	L	L	H
8	H	L	H	L
9	H	L	H	H
10	H	H	L	L
11	H	H	L	H

'90A, 'LS90
 RESET/COUNT FUNCTION TABLE

RESET INPUTS				OUTPUT			
R ₀ (1)	R ₀ (2)	R ₉ (1)	R ₉ (2)	Q _D	Q _C	Q _B	Q _A
H	H	L	X	L	L	L	L
H	H	X	L	L	L	L	L
X	X	H	H	H	L	L	H
X	L	X	L	COUNT			
L	X	L	X	COUNT			
L	X	X	L	COUNT			
X	L	L	X	COUNT			

'93A, 'LS93
 COUNT SEQUENCE
 (See Note C)

COUNT	OUTPUT			
	Q _D	Q _C	Q _B	Q _A
0	L	L	L	L
1	L	L	L	H
2	L	L	H	L
3	L	L	H	H
4	L	H	L	L
5	L	H	L	H
6	L	H	H	L
7	L	H	H	H
8	H	L	L	L
9	H	L	L	H
10	H	L	H	L
11	H	L	H	H
12	H	H	L	L
13	H	H	L	H
14	H	H	H	L
15	H	H	H	H

'92A, 'LS92, '93A, 'LS93
 RESET/COUNT FUNCTION TABLE

RESET INPUTS		OUTPUT			
R ₀ (1)	R ₀ (2)	Q _D	Q _C	Q _B	Q _A
H	H	L	L	L	L
L	X	COUNT			
X	L	COUNT			

- NOTES: A. Output Q_A is connected to input CKB for BCD count.
 B. Output Q_D is connected to input CKA for bi-quinary count.
 C. Output Q_A is connected to input CKB.
 D. H = high level, L = low level, X = irrelevant

SN5490A, SN5492A, SN5493A, SN54LS90, SN54LS92, SN54LS93 SN7490A, SN7492A, SN7493A, SN74LS90, SN74LS92, SN74LS93 DECADE, DIVIDE-BY-TWELVE AND BINARY COUNTERS

SDLS940A – MARCH 1974 – REVISED MARCH 1988

logic diagrams (positive logic)



The J and K inputs shown without connection are for reference only and are functionally at a high level. Pin numbers shown in () are for the 'LS93 and '93A and pin numbers shown in [] are for the 54L93.

schematics of inputs and outputs

'90A, '92A, '93A



SN5490A, SN5492A, SN5493A, SN54LS90, SN54LS92, SN54LS93
 SN7490A, SN7492A, SN7493A, SN74LS90, SN74LS92, SN74LS93
 DECADE, DIVIDE-BY-TWELVE AND BINARY COUNTERS

SDLS940A - MARCH 1974 - REVISED MARCH 1988

schematics of inputs and outputs (continued)

'LS90, 'LS92, 'LS93



SN5490A, SN5492A, SN5493A, SN54LS90, SN54LS92, SN54LS93 SN7490A, SN7492A, SN7493A, SN74LS90, SN74LS92, SN74LS93 DECADE, DIVIDE-BY-TWELVE AND BINARY COUNTERS

SDLS940A – MARCH 1974 – REVISED MARCH 1988

absolute maximum ratings over operating free-air temperature range (unless otherwise noted)

Supply voltage, V_{CC} (see Note 1)	7 V
Input voltage	5.5 V
Interemitter voltage (see Note 2)	5.5 V
Operating free-air temperature range: SN5490A, SN5492A, SN5493A	-55°C to 125°C
SN7490A, SN7492A, SN7493A	0°C to 70°C
Storage temperature range	-65°C to 150°C

NOTES: 1. Voltage values, except interemitter voltage, are with respect to network ground terminal.
2. This is the voltage between two emitters of a multiple-emitter transistor. For these circuits, this rating applies between the two R_0 inputs, and for the '90A circuit, it also applies between the two R_0 inputs.

recommended operating conditions

	SN5490A, SN5492A SN5493A			SN7490A, SN7492A SN7493A			UNIT
	MIN	NOM	MAX	MIN	NOM	MAX	
Supply voltage, V_{CC}	4.5	5	5.5	4.75	5	5.25	V
High-level output current, I_{OH}			-800			-800	μ A
Low-level output current, I_{OL}			16			16	mA
Count frequency, f_{count} (see Figure 1)	A input	0	32	0		32	MHz
	B input	0	16	0		16	
Pulse width, t_w	A input	15		15			ns
	B input	30		30			
	Reset inputs	15		15			
Reset inactive-state setup time, t_{su}		25			25		ns
Operating free-air temperature, T_A		-55	125		0	70	°C

electrical characteristics over recommended operating free-air temperature range (unless otherwise noted)

PARAMETER [¶]	TEST CONDITIONS [†]	'90A		'92A		'93A		UNIT			
		MIN	TYP [‡]	MAX	MIN	TYP [‡]	MAX		MIN	TYP [‡]	MAX
V_{IH} High-level input voltage		2			2		2		V		
V_{IL} Low-level input voltage				0.8		0.8		0.8	V		
V_{IK} Input clamp voltage	$V_{CC} = \text{MIN}, I_I = -12 \text{ mA}$			-1.5		-1.5		-1.5	V		
V_{OH} High-level output voltage	$V_{CC} = \text{MIN}, V_{IH} = 2 \text{ V}, V_{IL} = 0.8 \text{ V}, I_{OH} = -800 \mu\text{A}$	2.4	3.4		2.4	3.4		2.4	3.4	V	
V_{OL} Low-level output voltage	$V_{CC} = \text{MIN}, V_{IH} = 2 \text{ V}, V_{IL} = 0.8 \text{ V}, I_{OL} = 16 \text{ mA}^{\parallel}$		0.2	0.4		0.2	0.4		0.2	0.4	V
I_I Input current at maximum input voltage	$V_{CC} = \text{MAX}, V_I = 5.5 \text{ V}$			1		1			1	mA	
I_{IH} High-level input current	Any reset CKA CKB $V_{CC} = \text{MAX}, V_I = 2.4 \text{ V}$			40		40		40		μ A	
				80		80		80			
				120		120		80			
I_{IL} Low-level input current	Any reset CKA CKB $V_{CC} = \text{MAX}, V_I = 0.4 \text{ V}$			-1.6		-1.6		-1.6		mA	
				-3.2		-3.2		-3.2			
				-4.8		-4.8		-3.2			
I_{OS} Short-circuit output current [§]	$V_{CC} = \text{MAX}$	SN54'	-20	-57	-20	-57	-20	-57		mA	
		SN74'	-18	-57	-18	-57	-18	-57			
I_{CC} Supply current	$V_{CC} = \text{MAX}, \text{ See Note 3}$		29	42		26	39		26	39	mA

[†] For conditions shown as MIN or MAX, use the appropriate value specified under recommended operating conditions.

[‡] All typical values are at $V_{CC} = 5 \text{ V}, T_A = 25^\circ\text{C}$.

[§] Not more than one output should be shorted at a time.

[¶] '90A outputs are tested at $I_{OL} = 16 \text{ mA}$ plus the limit value for I_{IL} for the CKB input. This permits driving the CKB input while maintaining full fan-out capability.

NOTE 3: I_{CC} is measured with all outputs open, both R_0 inputs grounded following momentary connection to 4.5 V, and all other inputs grounded.



SN5490A, SN5492A, SN5493A, SN54LS90, SN54LS92, SN54LS93
 SN7490A, SN7492A, SN7493A, SN74LS90, SN74LS92, SN74LS93
 DECADE, DIVIDE-BY-TWELVE AND BINARY COUNTERS

SDLS940A - MARCH 1974 - REVISED MARCH 1988

switching characteristics, $V_{CC} = 5\text{ V}$, $T_A = 25^\circ\text{C}$

PARAMETER†	FROM (INPUT)	TO (OUTPUT)	TEST CONDITIONS	'90A			'92A			'93A			UNIT
				MIN	TYP	MAX	MIN	TYP	MAX	MIN	TYP	MAX	
f_{\max}	CKA	Q_A	$C_L = 15\text{ pF}$, $R_L = 400\ \Omega$, See Figure 1	32	42		32	42		32	42		MHz
	CKB	Q_B		16			16			16			
t_{PLH}	CKA	Q_A		10	16		10	16		10	16		ns
t_{PHL}				12	18		12	18		12	18		
t_{PLH}	CKA	Q_D		32	48		32	48		46	70		ns
t_{PHL}				34	50		34	50		46	70		
t_{PLH}	CKB	Q_B		10	16		10	16		10	16		ns
t_{PHL}				14	21		14	21		14	21		
t_{PLH}	CKB	Q_C		21	32		10	16		21	32		ns
t_{PHL}				23	35		14	21		23	35		
t_{PLH}	CKB	Q_D		21	32		21	32		34	51		ns
t_{PHL}				23	35		23	35		34	51		
t_{PHL}	Set-to-0	Any		26	40		26	40		26	40		ns
t_{PLH}	Set-to-9	Q_A, Q_D		20	30								ns
t_{PHL}		Q_B, Q_C		26	40								

† f_{\max} = maximum count frequency
 t_{PLH} = propagation delay time, low-to-high-level output
 t_{PHL} = propagation delay time, high-to-low-level output



SN5490A, SN5492A, SN5493A, SN54LS90, SN54LS92, SN54LS93 SN7490A, SN7492A, SN7493A, SN74LS90, SN74LS92, SN74LS93 DECADE, DIVIDE-BY-TWELVE AND BINARY COUNTERS

SDLS940A – MARCH 1974 – REVISED MARCH 1988

absolute maximum ratings over operating free-air temperature range (unless otherwise noted)

Supply voltage, V_{CC} (see Note 1)	7 V
Input voltage: R inputs	7 V
A and B inputs	5.5 V
Operating free-air temperature range: SN54LS' Circuits	-55°C to 125°C
SN74LS' Circuits	0°C to 70°C
Storage temperature range	-65°C to 150°C

NOTE 1: Voltage values are with respect to network ground terminal.

recommended operating conditions

		SN54LS90 SN54LS92 SN54LS93			SN74LS90 SN74LS92 SN74LS93			UNIT
		MIN	NOM	MAX	MIN	NOM	MAX	
Supply voltage, V_{CC}		4.5	5	5.5	4.75	5	5.25	V
High-level output current, I_{OH}				-400			-400	μ A
Low-level output current, I_{OL}				4			8	mA
Count frequency, f_{count} (see Figure 1)	A input	0		32	0		32	MHz
	B input	0		16	0		16	
Pulse width, t_w	A input	15			15			ns
	B input	30			30			
	Reset inputs	30			30			
Reset inactive-state setup time, t_{su}		25			25			ns
Operating free-air temperature, T_A		-55		125	0		70	°C

electrical characteristics over recommended operating free-air temperature range (unless otherwise noted)

PARAMETER	TEST CONDITIONS†	SN54LS90 SN54LS92			SN74LS90 SN74LS92			UNIT
		MIN	TYP‡	MAX	MIN	TYP‡	MAX	
V_{IH} High-level input voltage		2			2			V
V_{IL} Low-level input voltage				0.7			0.8	V
V_{IK} Input clamp voltage	$V_{CC} = \text{MIN}, I_I = -18 \text{ mA}$			-1.5			-1.5	V
V_{OH} High-level output voltage	$V_{CC} = \text{MIN}, V_{IH} = 2 \text{ V}, V_{IL} = V_{IL \text{ max}}, I_{OH} = -400 \mu\text{A}$	2.5	3.4		2.7	3.4		V
V_{OL} Low-level output voltage	$V_{CC} = \text{MIN}, V_{IH} = 2 \text{ V}, V_{IL} = V_{IL \text{ max}}, I_{OL} = 4 \text{ mA} \text{ ¶}$ $I_{OL} = 8 \text{ mA} \text{ ¶}$	0.25	0.4		0.25	0.4		V
					0.35	0.5		
I_I Input current at maximum input voltage	Any reset			0.1			0.1	mA
	CKA			0.2			0.2	
	CKB			0.4			0.4	
I_{IH} High-level input current	Any reset			20			20	μ A
	CKA			40			40	
	CKB			80			80	
I_{IL} Low-level input current	Any reset			-0.4			-0.4	mA
	CKA			-2.4			-2.4	
	CKB			-3.2			-3.2	
I_{OS} Short-circuit output current§	$V_{CC} = \text{MAX}$	-20		-100	-20		-100	mA
I_{CC} Supply current	$V_{CC} = \text{MAX},$ See Note 3	'LS90	9	15	9	15		mA
		'LS92	9	15	9	15		

† For conditions shown as MIN or MAX, use the appropriate value specified under recommended operating conditions.

‡ All typical values are at $V_{CC} = 5 \text{ V}, T_A = 25^\circ\text{C}$.

§ Not more than one output should be shorted at a time, and duration of the short-circuit should not exceed one second.

¶ I_{OL} outputs are tested at specified I_{OL} plus the limit value of I_{IL} for the CKB input. This permits driving the CKB input while maintaining full fan-out capability.

NOTE 3: I_{CC} is measured with all outputs open, both R_0 inputs grounded following momentary connection to 4.5 V, and all other inputs grounded.



SN5490A, SN5492A, SN5493A, SN54LS90, SN54LS92, SN54LS93
 SN7490A, SN7492A, SN7493A, SN74LS90, SN74LS92, SN74LS93
 DECADE, DIVIDE-BY-TWELVE AND BINARY COUNTERS

SDLS940A - MARCH 1974 - REVISED MARCH 1988

electrical characteristics over recommended operating free-air temperature range (unless otherwise noted)

PARAMETER	TEST CONDITIONS†	SN54LS93			SN74LS93			UNIT	
		MIN	TYP‡	MAX	MIN	TYP‡	MAX		
V _{IH} High-level input voltage		2			2			V	
V _{IL} Low-level input voltage				0.7			0.8	V	
V _{IK} Input clamp voltage	V _{CC} = MIN, I _I = -18 mA			-1.5			-1.5	V	
V _{OH} High-level output voltage	V _{CC} = MIN, V _{IH} = 2 V, V _{IL} = V _{IL} max, I _{OH} = -400 μA	2.5	3.4		2.7	3.4		V	
V _{OL} Low-level output voltage	V _{CC} = MIN, V _{IH} = 2 V, V _{IL} = V _{IL} max	I _{OL} = 4 mA¶			0.25	0.4	0.25	0.4	V
		I _{OL} = 8 mA¶					0.35	0.5	
I _I Input current at maximum input voltage	Any reset	V _{CC} = MAX, V _I = 7 V					0.1	mA	
	CKA or CKB	V _{CC} = MAX, V _I = 5.5 V					0.2		
I _{IH} High-level input current	Any reset	V _{CC} = MAX, V _I = 2.7 V			20		20	μA	
	CKA or CKB				40		80		
I _{IL} Low-level input current	Any reset	V _{CC} = MAX, V _I = 0.4 V					-0.4	mA	
	CKA						-2.4		
	CKB						-1.6		
I _{OS} Short-circuit output current §	V _{CC} = MAX	-20		-100	-20		-100	mA	
I _{CC} Supply current	V _{CC} = MAX, See Note 3		9	15		9	15	mA	

† For conditions shown as MIN or MAX, use the appropriate value specified under recommended operating conditions.

‡ All typical values are at V_{CC} = 5 V, T_A = 25°C.

§ Not more than one output should be shorted at a time, and duration of the short-circuit should not exceed one second.

¶ Q_A outputs are tested at specified I_{OL} plus the limit value for I_{IL} for the CKB input. This permits driving the CKB input while maintaining full fan-out capability.

NOTE 3: I_{CC} is measured with all outputs open, both R_Q inputs grounded following momentary connection to 4.5 V, and all other inputs grounded.

switching characteristics, V_{CC} = 5 V, T_A = 25°C

PARAMETER#	FROM (INPUT)	TO (OUTPUT)	TEST CONDITIONS	'LS90			'LS92			'LS93			UNIT
				MIN	TYP	MAX	MIN	TYP	MAX	MIN	TYP	MAX	
f _{max}	CKA	Q _A	C _L = 15 pF, R _L = 2 kΩ See Figure 1	32	42		32	42		32	42		MHz
	CKB	Q _B		16			16			16			
t _{PLH}	CKA	Q _A		10	16		10	16		10	16		ns
				12	18		12	18		12	18		
t _{PHL}	CKA	Q _D		32	48		32	48		46	70		ns
				34	50		34	50		46	70		
t _{PLH}	CKB	Q _B		10	16		10	16		10	16		ns
				14	21		14	21		14	21		
t _{PHL}	CKB	Q _C		21	32		10	16		21	32		ns
				23	35		14	21		23	35		
t _{PLH}	CKB	Q _D		21	32		21	32		34	51		ns
				23	35		23	35		34	51		
t _{PHL}	Set-to-0	Any		26	40		26	40		26	40		ns
t _{PLH}	Set-to-9	Q _A , Q _D		20	30								ns
		Q _B , Q _C		26	40								

#f_{max} = maximum count frequency

t_{PLH} = propagation delay time, low-to-high-level output

t_{PHL} = propagation delay time, high-to-low-level output



SN5490A, SN5492A, SN5493A, SN54LS90, SN54LS92, SN54LS93
 SN7490A, SN7492A, SN7493A, SN74LS90, SN74LS92, SN74LS93
 DECADE, DIVIDE-BY-TWELVE AND BINARY COUNTERS

SDLS940A - MARCH 1974 - REVISED MARCH 1988

PARAMETER MEASUREMENT INFORMATION

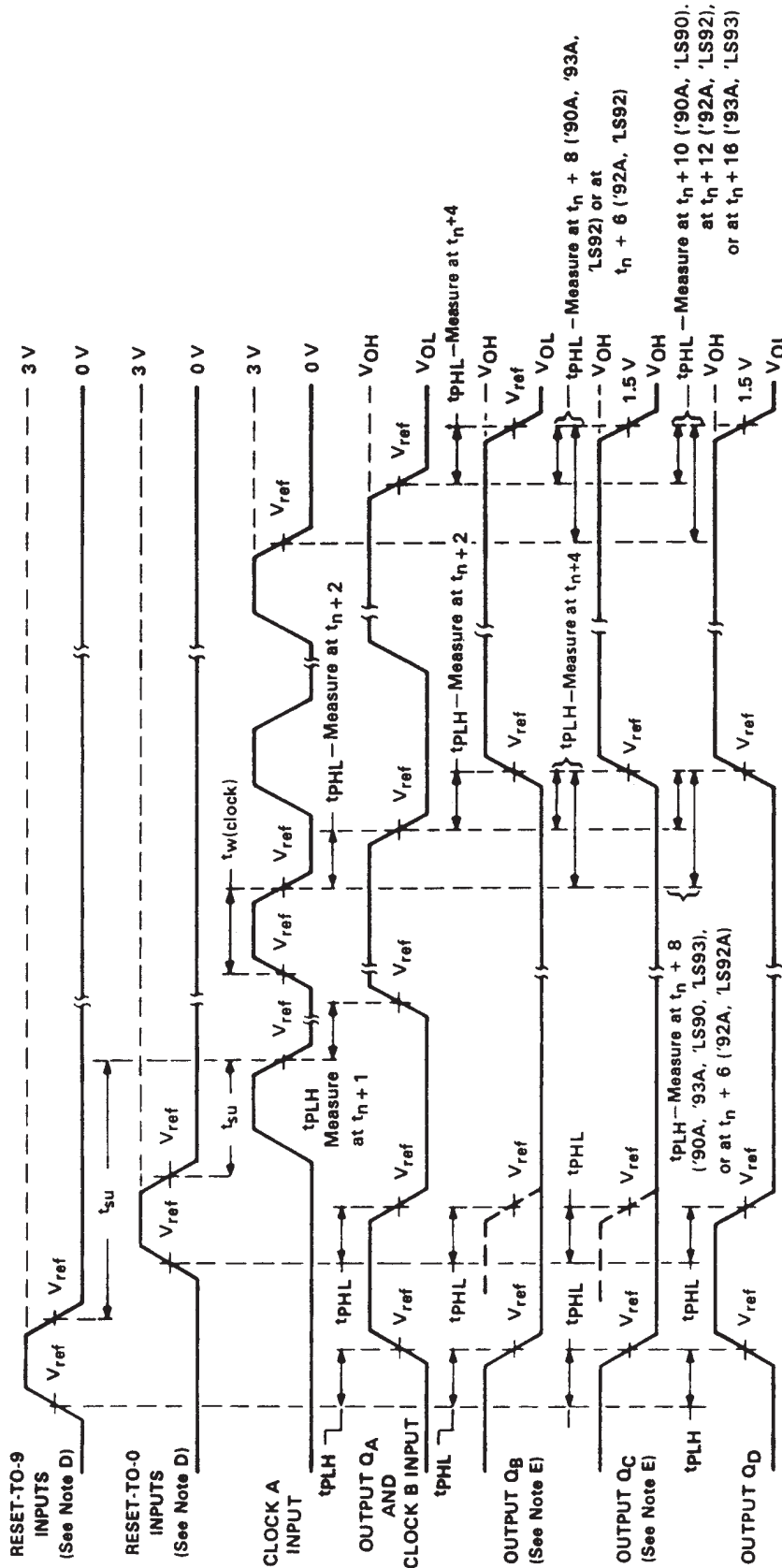

NOTES: A. Input pulses are supplied by a generator having the following characteristics:

- for '90A, '92A, '93A, $t_r \leq 5$ ns, $t_f \leq 5$ ns, PRR = 1 MHz, duty cycle = 50%, $Z_{out} \approx 50$ ohms;
- for 'LS90, 'LS92, 'LS93, $t_r \leq 15$ ns, $t_f \leq 5$ ns, PRR = 1 MHz, duty cycle = 50%, $Z_{out} \approx 50$ ohms.
- B. C_L includes probe and jig capacitance.
- C. All diodes are 1N3064 or equivalent.
- D. Each reset input is tested separately with the other reset at 4.5 V.
- E. Reference waveforms are shown with dashed lines.
- F. For '90A, '92A, and '93A; $V_{ref} = 1.5$ V. For 'LS90, 'LS92, and 'LS93; $V_{ref} = 1.3$ V.

FIGURE 1A

PARAMETER MEASUREMENT INFORMATION



- NOTES: A. Input pulses are supplied by a generator having the following characteristics:
for '90A, '92A, '93A, $t_r \leq 5$ ns, $t_f \leq 5$ ns, PRR = 1 MHz, duty cycle = 50%, $Z_{out} \approx 50$ ohms;
for 'LS90, 'LS92, 'LS93, $t_r \leq 15$ ns, $t_f \leq 5$ ns, PRR = 1 MHz, duty cycle = 50%, $Z_{out} \approx 50$ ohms.
- B. C_L includes probe and jig capacitance.
- C. All diodes are 1N3064 or equivalent.
- D. Each reset input is tested separately with the other reset at 4.5 V.
- E. Reference waveforms are shown with dashed lines.
- F. For '90A, '92A, and '93A; $V_{ref} = 1.5$ V. For 'LS90, 'LS92, and 'LS93; $V_{ref} = 1.3$ V.

FIGURE 1B

PACKAGING INFORMATION

Orderable Device	Status (1)	Package Type	Package Drawing	Pins	Package Qty	Eco Plan (2)	Lead finish/ Ball material (6)	MSL Peak Temp (3)	Op Temp (°C)	Device Marking (4/5)	Samples
7603201CA	ACTIVE	CDIP	J	14	1	Non-RoHS & Green	SNPB	N / A for Pkg Type	-55 to 125	7603201CA SNJ54LS90J	Samples
7700101CA	ACTIVE	CDIP	J	14	1	Non-RoHS & Green	SNPB	N / A for Pkg Type	-55 to 125	7700101CA SNJ54LS93J	Samples
7700101DA	ACTIVE	CFP	W	14	1	Non-RoHS & Green	SNPB	N / A for Pkg Type	-55 to 125	7700101DA SNJ54LS93W	Samples
JM38510/31501BCA	ACTIVE	CDIP	J	14	1	Non-RoHS & Green	SNPB	N / A for Pkg Type	-55 to 125	JM38510/ 31501BCA	Samples
JM38510/31502BCA	ACTIVE	CDIP	J	14	1	Non-RoHS & Green	SNPB	N / A for Pkg Type	-55 to 125	JM38510/ 31502BCA	Samples
JM38510/31502BDA	ACTIVE	CFP	W	14	1	Non-RoHS & Green	SNPB	N / A for Pkg Type	-55 to 125	JM38510/ 31502BDA	Samples
M38510/31501BCA	ACTIVE	CDIP	J	14	1	Non-RoHS & Green	SNPB	N / A for Pkg Type	-55 to 125	JM38510/ 31501BCA	Samples
M38510/31502BCA	ACTIVE	CDIP	J	14	1	Non-RoHS & Green	SNPB	N / A for Pkg Type	-55 to 125	JM38510/ 31502BCA	Samples
M38510/31502BDA	ACTIVE	CFP	W	14	1	Non-RoHS & Green	SNPB	N / A for Pkg Type	-55 to 125	JM38510/ 31502BDA	Samples
SN54LS90J	ACTIVE	CDIP	J	14	1	Non-RoHS & Green	SNPB	N / A for Pkg Type	-55 to 125	SN54LS90J	Samples
SN54LS93J	ACTIVE	CDIP	J	14	1	Non-RoHS & Green	SNPB	N / A for Pkg Type	-55 to 125	SN54LS93J	Samples
SN74LS90D	ACTIVE	SOIC	D	14	50	RoHS & Green	NIPDAU	Level-1-260C-UNLIM	0 to 70	LS90	Samples
SN74LS90DE4	ACTIVE	SOIC	D	14	50	RoHS & Green	NIPDAU	Level-1-260C-UNLIM	0 to 70	LS90	Samples
SN74LS90DG4	ACTIVE	SOIC	D	14	50	RoHS & Green	NIPDAU	Level-1-260C-UNLIM	0 to 70	LS90	Samples
SN74LS90DR	ACTIVE	SOIC	D	14	2500	RoHS & Green	NIPDAU	Level-1-260C-UNLIM	0 to 70	LS90	Samples
SN74LS90DRG4	ACTIVE	SOIC	D	14	2500	RoHS & Green	NIPDAU	Level-1-260C-UNLIM	0 to 70	LS90	Samples
SN74LS90N	ACTIVE	PDIP	N	14	25	RoHS & Green	NIPDAU	N / A for Pkg Type	0 to 70	SN74LS90N	Samples
SN74LS90NE4	ACTIVE	PDIP	N	14	25	RoHS & Green	NIPDAU	N / A for Pkg Type	0 to 70	SN74LS90N	Samples

Orderable Device	Status (1)	Package Type	Package Drawing	Pins	Package Qty	Eco Plan (2)	Lead finish/ Ball material (6)	MSL Peak Temp (3)	Op Temp (°C)	Device Marking (4/5)	Samples
SN74LS90NSR	ACTIVE	SO	NS	14	2000	RoHS & Green	NIPDAU	Level-1-260C-UNLIM		74LS90	Samples
SN74LS92D	ACTIVE	SOIC	D	14	50	RoHS & Green	NIPDAU	Level-1-260C-UNLIM	0 to 70	LS92	Samples
SN74LS92N	ACTIVE	PDIP	N	14	25	RoHS & Green	NIPDAU	N / A for Pkg Type	0 to 70	SN74LS92N	Samples
SN74LS92NSR	ACTIVE	SO	NS	14	2000	RoHS & Green	NIPDAU	Level-1-260C-UNLIM	0 to 70	74LS92	Samples
SN74LS93D	ACTIVE	SOIC	D	14	50	RoHS & Green	NIPDAU	Level-1-260C-UNLIM	0 to 70	LS93	Samples
SN74LS93N	ACTIVE	PDIP	N	14	25	RoHS & Green	NIPDAU	N / A for Pkg Type	0 to 70	SN74LS93N	Samples
SNJ54LS90J	ACTIVE	CDIP	J	14	1	Non-RoHS & Green	SNPB	N / A for Pkg Type	-55 to 125	7603201CA SNJ54LS90J	Samples
SNJ54LS93J	ACTIVE	CDIP	J	14	1	Non-RoHS & Green	SNPB	N / A for Pkg Type	-55 to 125	7700101CA SNJ54LS93J	Samples
SNJ54LS93W	ACTIVE	CFP	W	14	1	Non-RoHS & Green	SNPB	N / A for Pkg Type	-55 to 125	7700101DA SNJ54LS93W	Samples

(1) The marketing status values are defined as follows:

ACTIVE: Product device recommended for new designs.

LIFEBUY: TI has announced that the device will be discontinued, and a lifetime-buy period is in effect.

NRND: Not recommended for new designs. Device is in production to support existing customers, but TI does not recommend using this part in a new design.

PREVIEW: Device has been announced but is not in production. Samples may or may not be available.

OBSOLETE: TI has discontinued the production of the device.

(2) **RoHS:** TI defines "RoHS" to mean semiconductor products that are compliant with the current EU RoHS requirements for all 10 RoHS substances, including the requirement that RoHS substance do not exceed 0.1% by weight in homogeneous materials. Where designed to be soldered at high temperatures, "RoHS" products are suitable for use in specified lead-free processes. TI may reference these types of products as "Pb-Free".

RoHS Exempt: TI defines "RoHS Exempt" to mean products that contain lead but are compliant with EU RoHS pursuant to a specific EU RoHS exemption.

Green: TI defines "Green" to mean the content of Chlorine (Cl) and Bromine (Br) based flame retardants meet JS709B low halogen requirements of <=1000ppm threshold. Antimony trioxide based flame retardants must also meet the <=1000ppm threshold requirement.

(3) MSL, Peak Temp. - The Moisture Sensitivity Level rating according to the JEDEC industry standard classifications, and peak solder temperature.

(4) There may be additional marking, which relates to the logo, the lot trace code information, or the environmental category on the device.

(5) Multiple Device Markings will be inside parentheses. Only one Device Marking contained in parentheses and separated by a "-" will appear on a device. If a line is indented then it is a continuation of the previous line and the two combined represent the entire Device Marking for that device.

(6) Lead finish/Ball material - Orderable Devices may have multiple material finish options. Finish options are separated by a vertical ruled line. Lead finish/Ball material values may wrap to two lines if the finish value exceeds the maximum column width.

Important Information and Disclaimer:The information provided on this page represents TI's knowledge and belief as of the date that it is provided. TI bases its knowledge and belief on information provided by third parties, and makes no representation or warranty as to the accuracy of such information. Efforts are underway to better integrate information from third parties. TI has taken and continues to take reasonable steps to provide representative and accurate information but may not have conducted destructive testing or chemical analysis on incoming materials and chemicals. TI and TI suppliers consider certain information to be proprietary, and thus CAS numbers and other limited information may not be available for release.

In no event shall TI's liability arising out of such information exceed the total purchase price of the TI part(s) at issue in this document sold by TI to Customer on an annual basis.

OTHER QUALIFIED VERSIONS OF SN54LS90, SN54LS93, SN74LS90, SN74LS93 :

- Catalog : [SN74LS90](#), [SN74LS93](#)
- Military : [SN54LS90](#), [SN54LS93](#)

NOTE: Qualified Version Definitions:

- Catalog - TI's standard catalog product
- Military - QML certified for Military and Defense Applications

TAPE AND REEL INFORMATION



QUADRANT ASSIGNMENTS FOR PIN 1 ORIENTATION IN TAPE



*All dimensions are nominal

Device	Package Type	Package Drawing	Pins	SPQ	Reel Diameter (mm)	Reel Width W1 (mm)	A0 (mm)	B0 (mm)	K0 (mm)	P1 (mm)	W (mm)	Pin1 Quadrant
SN74LS90DR	SOIC	D	14	2500	330.0	16.4	6.5	9.0	2.1	8.0	16.0	Q1
SN74LS90NSR	SO	NS	14	2000	330.0	16.4	8.2	10.5	2.5	12.0	16.0	Q1
SN74LS92NSR	SO	NS	14	2000	330.0	16.4	8.2	10.5	2.5	12.0	16.0	Q1

TAPE AND REEL BOX DIMENSIONS

*All dimensions are nominal

Device	Package Type	Package Drawing	Pins	SPQ	Length (mm)	Width (mm)	Height (mm)
SN74LS90DR	SOIC	D	14	2500	853.0	449.0	35.0
SN74LS90NSR	SO	NS	14	2000	853.0	449.0	35.0
SN74LS92NSR	SO	NS	14	2000	853.0	449.0	35.0

MECHANICAL DATA

NS (R-PDSO-G**)

PLASTIC SMALL-OUTLINE PACKAGE

14-PINS SHOWN



- NOTES:
- A. All linear dimensions are in millimeters.
 - B. This drawing is subject to change without notice.
 - C. Body dimensions do not include mold flash or protrusion, not to exceed 0,15.

W (R-GDFP-F14)

CERAMIC DUAL FLATPACK



- NOTES:
- A. All linear dimensions are in inches (millimeters).
 - B. This drawing is subject to change without notice.
 - C. This package can be hermetically sealed with a ceramic lid using glass frit.
 - D. Index point is provided on cap for terminal identification only.
 - E. Falls within MIL STD 1835 GDFP1-F14

J 14

GENERIC PACKAGE VIEW
CDIP - 5.08 mm max height
CERAMIC DUAL IN LINE PACKAGE



Images above are just a representation of the package family, actual package may vary.
Refer to the product data sheet for package details.

4040083-5/G



J0014A

PACKAGE OUTLINE

CDIP - 5.08 mm max height

CERAMIC DUAL IN LINE PACKAGE

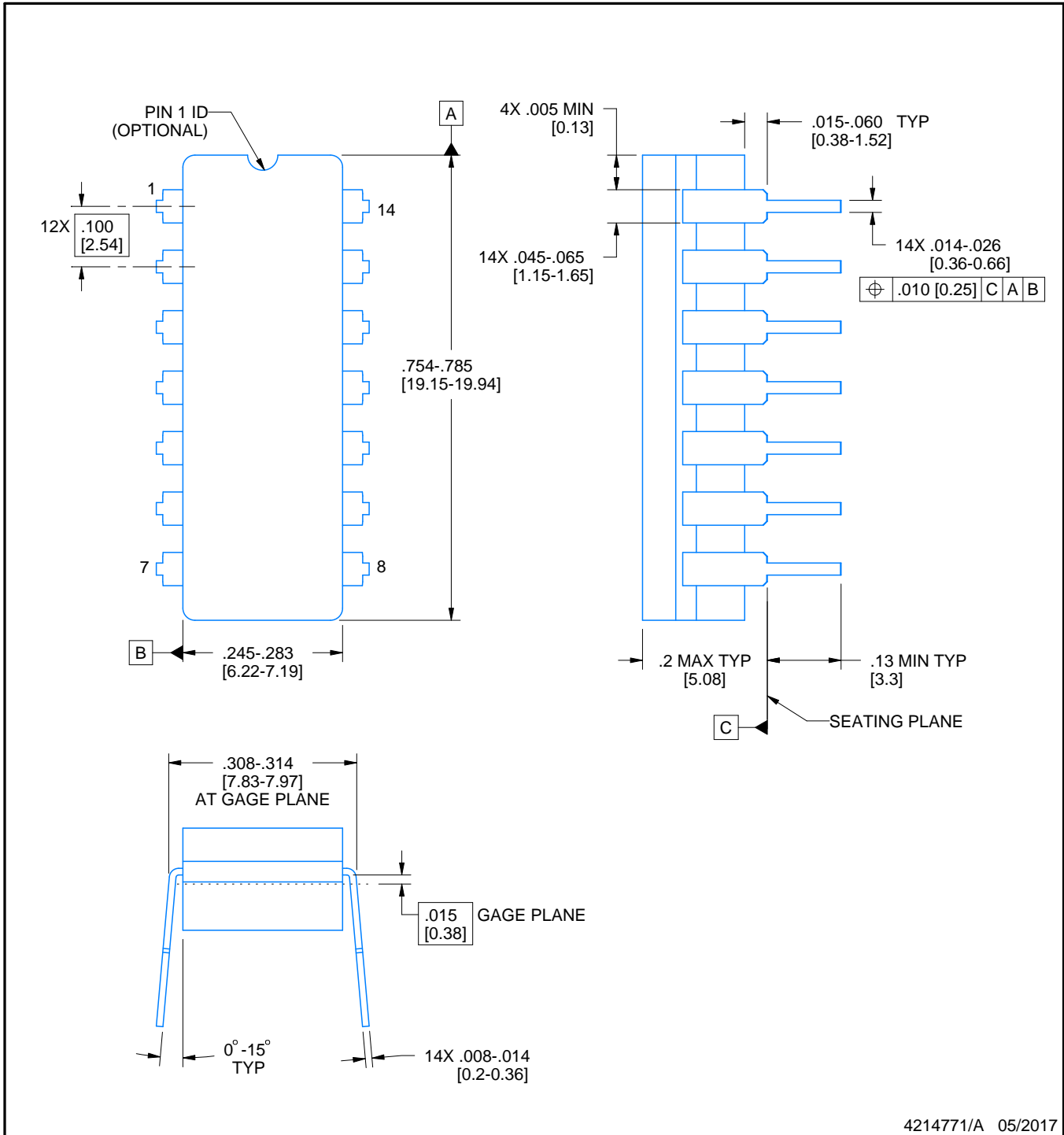

4214771/A 05/2017

NOTES:

1. All controlling linear dimensions are in inches. Dimensions in brackets are in millimeters. Any dimension in brackets or parenthesis are for reference only. Dimensioning and tolerancing per ASME Y14.5M.
2. This drawing is subject to change without notice.
3. This package is hermetically sealed with a ceramic lid using glass frit.
4. Index point is provided on cap for terminal identification only and on press ceramic glass frit seal only.
5. Falls within MIL-STD-1835 and GDIP1-T14.

EXAMPLE BOARD LAYOUT

J0014A

CDIP - 5.08 mm max height

CERAMIC DUAL IN LINE PACKAGE



LAND PATTERN EXAMPLE
NON-SOLDER MASK DEFINED
SCALE: 5X



4214771/A 05/2017

D (R-PDSO-G14)

PLASTIC SMALL OUTLINE



- NOTES:
- A. All linear dimensions are in inches (millimeters).
 - B. This drawing is subject to change without notice.
 -  Body length does not include mold flash, protrusions, or gate burrs. Mold flash, protrusions, or gate burrs shall not exceed 0.006 (0,15) each side.
 -  Body width does not include interlead flash. Interlead flash shall not exceed 0.017 (0,43) each side.
 - E. Reference JEDEC MS-012 variation AB.

D (R-PDSO-G14)

PLASTIC SMALL OUTLINE





- NOTES:
- All linear dimensions are in millimeters.
 - This drawing is subject to change without notice.
 - Publication IPC-7351 is recommended for alternate designs.
 - Laser cutting apertures with trapezoidal walls and also rounding corners will offer better paste release. Customers should contact their board assembly site for stencil design recommendations. Refer to IPC-7525 for other stencil recommendations.
 - Customers should contact their board fabrication site for solder mask tolerances between and around signal pads.

N (R-PDIP-T**)

PLASTIC DUAL-IN-LINE PACKAGE

16 PINS SHOWN



- NOTES:
- A. All linear dimensions are in inches (millimeters).
 - B. This drawing is subject to change without notice.
 -  Falls within JEDEC MS-001, except 18 and 20 pin minimum body length (Dim A).
 -  The 20 pin end lead shoulder width is a vendor option, either half or full width.

IMPORTANT NOTICE AND DISCLAIMER

TI PROVIDES TECHNICAL AND RELIABILITY DATA (INCLUDING DATASHEETS), DESIGN RESOURCES (INCLUDING REFERENCE DESIGNS), APPLICATION OR OTHER DESIGN ADVICE, WEB TOOLS, SAFETY INFORMATION, AND OTHER RESOURCES "AS IS" AND WITH ALL FAULTS, AND DISCLAIMS ALL WARRANTIES, EXPRESS AND IMPLIED, INCLUDING WITHOUT LIMITATION ANY IMPLIED WARRANTIES OF MERCHANTABILITY, FITNESS FOR A PARTICULAR PURPOSE OR NON-INFRINGEMENT OF THIRD PARTY INTELLECTUAL PROPERTY RIGHTS.

These resources are intended for skilled developers designing with TI products. You are solely responsible for (1) selecting the appropriate TI products for your application, (2) designing, validating and testing your application, and (3) ensuring your application meets applicable standards, and any other safety, security, or other requirements. These resources are subject to change without notice. TI grants you permission to use these resources only for development of an application that uses the TI products described in the resource. Other reproduction and display of these resources is prohibited. No license is granted to any other TI intellectual property right or to any third party intellectual property right. TI disclaims responsibility for, and you will fully indemnify TI and its representatives against, any claims, damages, costs, losses, and liabilities arising out of your use of these resources.

TI's products are provided subject to TI's Terms of Sale (<https://www.ti.com/legal/termsofsale.html>) or other applicable terms available either on [ti.com](https://www.ti.com) or provided in conjunction with such TI products. TI's provision of these resources does not expand or otherwise alter TI's applicable warranties or warranty disclaimers for TI products.

Mailing Address: Texas Instruments, Post Office Box 655303, Dallas, Texas 75265
Copyright © 2021, Texas Instruments Incorporated