

Instruction Manual

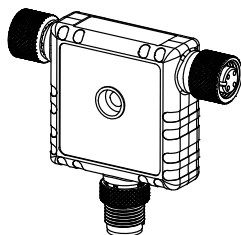

- Connects two IO-Link devices and provides access via Modbus RTU interface
- Rugged design; easy installation with no assembly or individual wiring required
- 5-pin M12 male quick-disconnect connector
- Two 4-pin M12 female quick-disconnect connectors
- Built-in indication for two IO-Link master ports
- Built-in indication for Modbus RTU connection status
- Rugged over-molded design meets IP65, IP67, and IP68

Models

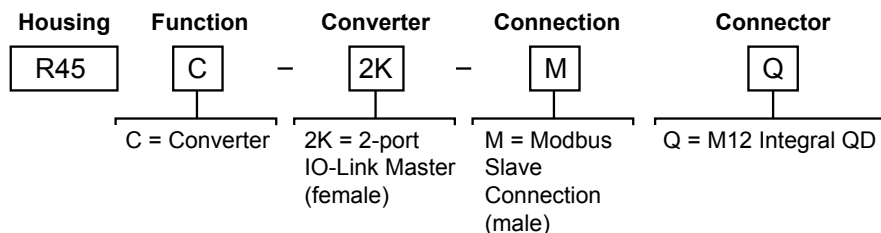

Overview

The R45C 2-Port Converter connects to two IO-Link devices and provides access to IO-Link data and functionality via a Modbus RTU connection.

Modbus registers allow for access to both IO-Link devices and their functions:

- Process Data In
- Process Data Out
- Connected device information
- ISDU data
- Discrete I/O configuration
- IO-Link events
- Data storage
- SIO mode

For more information, see p/n 221399 *IO-Link to ModBus Converter - Device Register Map*.



Status Indicators

The R45C-2K-MQ IO-Link Master/Modbus Converter has matching RGB LED indicators on both sides for each IO-Link device port to allow for installation needs and still provide adequate indication visibility. There is also an Amber LED indicator on both sides of the converter, which is specific to the Modbus communication.

Figure 1. R45C 2-Port Converter status indicators – front and back

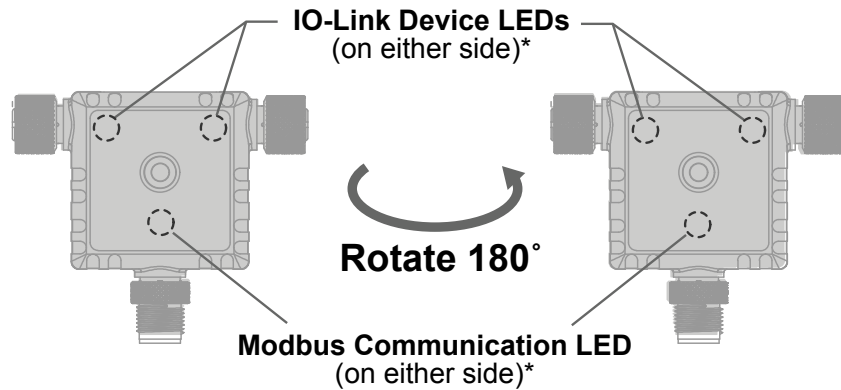

* Indicator LEDs are visible through translucent housing

IO-Link Device Port 1 and Port 2 RGB LEDs		Modbus Communication Amber LED	
Indication	Status	Indication	Status
Off	Deactivated port	Flashing Amber (4 Hz)	Modbus communications are active
Flashing Green	Waiting for IO-Link device	Solid Amber (2 seconds) to Off	Modbus communications are lost after connection
Solid Green	IO-Link device is connected	Solid Amber (2 seconds) to Flashing Amber (4 Hz)	Modbus communications momentarily lost, but then reestablished
Flashing Red	Validation Error	Solid Amber	Modbus communications are intermittent, or communications error occurs more frequently once every 2 seconds
Solid Yellow	Signal high in SIO-mode	Off	Modbus communications are not present
Solid Blue	Processor communication error		

Installation Instructions

Mechanical Installation

Install the R45C 2-Port Converter to allow access for functional checks, maintenance, and service or replacement.

All mounting hardware is supplied by the user. Fasteners must be of sufficient strength to guard against breakage. Use of permanent fasteners or locking hardware is recommended to prevent the loosening or displacement of the device. The mounting hole (4.5 mm) in the R45C 2-Port Converter accepts M4 (#8) hardware. See the figure below to help in determining the minimum screw length.

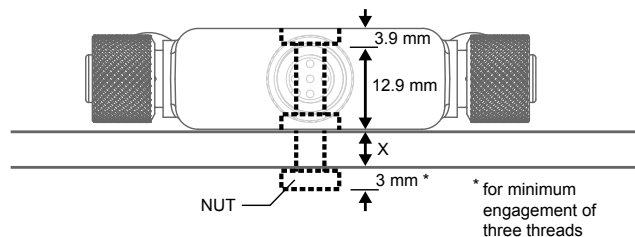

Screw Length (with screw head fitting in counterbore) = 12.9 mm + "X" mm + 3 mm



CAUTION: Do not overtighten the R45C 2-Port Converter's mounting screw during installation. Overtightening can affect the performance of the R45C 2-Port Converter.

Wiring

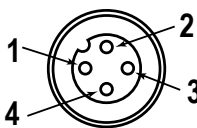
Port 1 and Port 2 – Female	Pin	Signal Description
	1	18 V DC to 30 V DC
	2	I/Q (digital in-out)
	3	Ground
	4	C/Q (communications/digital in-out)

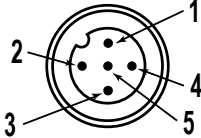
Comm Port – Male	Pin	Signal Description
	1	18 V DC to 30 V DC
	2	RS485/D1/B/+
	3	Ground
	4	RS485/D0/A-
	5	Banner 1-wire

Specifications

Voltage Input Range

18 V DC to 30 V DC

Input Power

24 V DC at 4A

Output Power

24 V DC at 50 mA + 200 mA/port = 450 mA maximum

Supply Protection Circuitry

Protected against reverse polarity and transient voltages

Leakage Current Immunity

400 µA

Indicators

RGB1: IO-Link Port 1 Status
 RGB2: IO-Link Port 2 Status
 Amber: Modbus Communications

Connections

(2) Integral 4-pin M12 female quick-disconnect connector
 (1) Integral 5-pin M12 male quick-disconnect connector

Construction

Coupling Material: Nickel-plated brass
 Connector Body: PVC translucent black

Vibration and Mechanical Shock

Meets IEC 60068-2-6 requirements (Vibration: 10 Hz to 55 Hz, 1.0 mm amplitude, 5 minutes sweep, 30 minutes dwell)
 Meets IEC 60068-2-27 requirements (Shock: 30G 11 ms duration, half sine wave)

Environmental Ratings

For Indoor Use Only
 IP65, IP67, IP68, UL Type 1

Operating Conditions

-40 °C to +70 °C (-40 °F to +158 °F)
 90% at +70 °C maximum relative humidity (non-condensing)
Storage Temperature: -40 °C to +80 °C (-40 °F to +176 °F)

IO-Link Baud Rates

COM1: 4.8 kbps
 COM2: 38.4 kbps
 COM3: 230.4 kbps

Compliant Standards

IO-Link interface and System Specification v 1.1.2
 IO-Link Test Specification v 1.1.2

Master Communication Protocol

RS485 – Modbus RTU

Digital Inputs (SIO [DI] Mode)

Input Current: 5 mA typical
 ON Voltage/Current: 15 V DC minimum/5 mA minimum
 OFF Voltage: 5 V DC maximum

Digital Outputs (SIO [DO] Mode)

On-Resistance: 120 mΩ typical, 250 mΩ maximum
 Current Limit: 0.7 A minimum, 1.0 A typical, 1.3 A maximum
 Off Leakage Current: -10 µA minimum, 10 µA maximum

Certifications



Banner Engineering Europe
 Park Lane, Culliganlaan 2F bus
 3, 1831 Diegem, BELGIUM



Turck Banner LTD Blenheim
 House, Blenheim Court,
 Wickford, Essex SS11 8YT,
 Great Britain



Dimensions

All measurements are listed in millimeters [inches], unless noted otherwise.

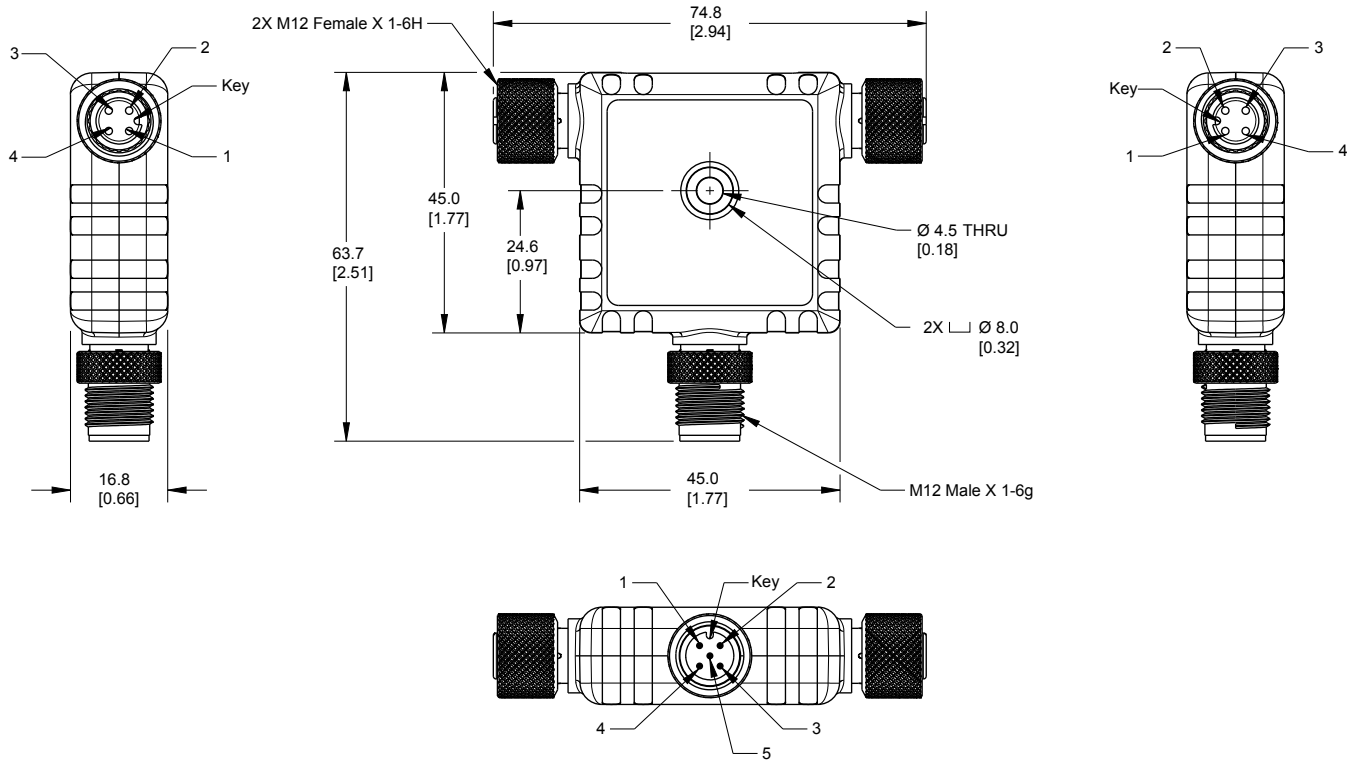

Accessories

Cordsets

5-Pin Threaded M12 Cordsets—Double Ended					
Model	Length	Style	Dimensions	Pinout (Male)	Pinout (Female)
MQDEC-501SS	0.31 m (1.02 ft)	Male Straight/ Female Straight			
MQDEC-503SS	0.91 m (2.99 ft)				
MQDEC-506SS	1.83 m (6 ft)				
MQDEC-512SS	3.66 m (12 ft)				
MQDEC-515SS	5 m (16.4 ft)				
MQDEC-530SS	9 m (29.5 ft)				
MQDEC-550SS	15 m (49.2 ft)				
				1 = Brown 2 = White 3 = Blue	4 = Black 5 = Gray

5-Pin Threaded M12 Cordsets—Double Ended					
Model	Length	Style	Dimensions	Pinout (Male)	Pinout (Female)
MQDEC-501RS	0.31 m (1.02 ft)	Male Right-angle/Female Straight			
MQDEC-503RS	0.91 m (2.99 ft)				
MQDEC-506RS	1.83 m (6 ft)				
MQDEC-512RS	3.66 m (12 ft)				
				1 = Brown 2 = White 3 = Blue	4 = Black 5 = Gray

4-Pin Threaded M12 Cordsets—Double Ended					
Model	Length	Style	Dimensions	Pinout	
MQDEC-401SS	0.31 m (1 ft)	Male Straight/ Female Straight		<p>Female</p> <p>Male</p> <p>1 = Brown 2 = White 3 = Blue 4 = Black</p>	
MQDEC-403SS	0.91 m (2.99 ft)				
MQDEC-406SS	1.83 m (6 ft)				
MQDEC-412SS	3.66 m (12 ft)				
MQDEC-420SS	6.10 m (20 ft)				
MQDEC-430SS	9.14 m (30.2 ft)				
MQDEC-450SS	15.2 m (49.9 ft)				
MQDEC-403RS	0.91 m (2.99 ft)	Male Right-Angle/ Female Straight		<p>Female</p> <p>Male</p> <p>1 = Brown 2 = White 3 = Blue 4 = Black</p>	
MQDEC-406RS	1.83 m (6 ft)				
MQDEC-412RS	3.66 m (12 ft)				
MQDEC-420RS	6.10 m (20 ft)				
MQDEC-430RS	9.14 m (30.2 ft)				
MQDEC-450RS	15.2 m (49.9 ft)				
MQDEC-403RR	0.9 m (2.9 ft)	Male Right-Angle/ Female Right-Angle		<p>Female</p> <p>Male</p> <p>1 = Brown 2 = White 3 = Blue 4 = Black</p>	
MQDEC-406RR	1.8 m (5.9 ft)				
MQDEC-412RR	3.6 m (11.8 ft)				
MQDEC-420RR	6.1 m (20 ft)				

Maintenance and Service

Do not use alcoholic cleaning agents. The R45C 2-Port Converter is maintenance-free.

Banner Engineering Corp. Limited Warranty

Banner Engineering Corp. warrants its products to be free from defects in material and workmanship for one year following the date of shipment. Banner Engineering Corp. will repair or replace, free of charge, any product of its manufacture which, at the time it is returned to the factory, is found to have been defective during the warranty period. This warranty does not cover damage or liability for misuse, abuse, or the improper application or installation of the Banner product.

THIS LIMITED WARRANTY IS EXCLUSIVE AND IN LIEU OF ALL OTHER WARRANTIES WHETHER EXPRESS OR IMPLIED (INCLUDING, WITHOUT LIMITATION, ANY WARRANTY OF MERCHANTABILITY OR FITNESS FOR A PARTICULAR PURPOSE), AND WHETHER ARISING UNDER COURSE OF PERFORMANCE, COURSE OF DEALING OR TRADE USAGE.

This Warranty is exclusive and limited to repair or, at the discretion of Banner Engineering Corp., replacement. **IN NO EVENT SHALL BANNER ENGINEERING CORP. BE LIABLE TO BUYER OR ANY OTHER PERSON OR ENTITY FOR ANY EXTRA COSTS, EXPENSES, LOSSES, LOSS OF PROFITS, OR ANY INCIDENTAL, CONSEQUENTIAL OR SPECIAL DAMAGES RESULTING FROM ANY PRODUCT DEFECT OR FROM THE USE OR INABILITY TO USE THE PRODUCT, WHETHER ARISING IN CONTRACT OR WARRANTY, STATUTE, TORT, STRICT LIABILITY, NEGLIGENCE, OR OTHERWISE.**

Banner Engineering Corp. reserves the right to change, modify or improve the design of the product without assuming any obligations or liabilities relating to any product previously manufactured by Banner Engineering Corp. Any misuse, abuse, or improper application or installation of this product or use of the product for personal protection applications when the product is identified as not intended for such purposes will void the product warranty. Any modifications to this product without prior express approval by Banner Engineering Corp will void the product warranties. All specifications published in this document are subject to change; Banner reserves the right to modify product specifications or update documentation at any time. Specifications and product information in English supersede that which is provided in any other language. For the most recent version of any documentation, refer to: www.bannerengineering.com.

For patent information, see www.bannerengineering.com/patents.

FCC Part 15 Class B

This equipment has been tested and found to comply with the limits for a Class B digital device, pursuant to part 15 of the FCC Rules. These limits are designed to provide reasonable protection against harmful interference in a residential installation. This equipment generates, uses and can radiate radio frequency energy and, if not installed and used in accordance with the instructions, may cause harmful interference to radio communications. However, there is no guarantee that interference will not occur in a particular installation. If this equipment does cause harmful interference to radio or television reception, which can be determined by turning the equipment off and on, the user is encouraged to try to correct the interference by one or more of the following measures:

- Reorient or relocate the receiving antenna.
- Increase the separation between the equipment and receiver.
- Connect the equipment into an outlet on a circuit different from that to which the receiver is connected.
- Consult the dealer or an experienced radio/TV technician for help.

Industry Canada

This device complies with CAN ICES-3 (B)/NMB-3(B). Operation is subject to the following two conditions: 1) This device may not cause harmful interference; and 2) This device must accept any interference received, including interference that may cause undesired operation.

Cet appareil est conforme à la norme NMB-3(B). Le fonctionnement est soumis aux deux conditions suivantes : (1) ce dispositif ne peut pas occasionner d'interférences, et (2) il doit tolérer toute interférence, y compris celles susceptibles de provoquer un fonctionnement non souhaité du dispositif.



more sensors, more solutions