

PCN – Process Change Notification

| | |
|---------|----------------|
| Change: | MA208.A.AB.007 |
| Date: | 2016/09/29 |
| Author | Annie Nien |

Affected Products

| Model# | Part Number | Changes |
|---|----------------|---|
| MA.208 Antenna Assembly GPS 3M RG-174 FAKRA Code C 2G/3G/4G 3M CFD-200 FAKRA Code D | MA208.A.AB.007 | Product part number, labels, heat-shrink tubes and 3M double-sided adhesive foam. |
| | | Packaging rules. |

Type of Change

- Hardware Modification
- Production Process Advance
- Others –Packaging rules changing.

Description of Change

1. Amend the part number from MA.208.A.AB.007 to MA208.A.AB.007
2. Amend Cellular Label to white 2G/3G/4G Label and the direction.
3. Add Heat-Shrink tube dimensions and tolerances.
4. Amend 3M double-sided adhesive foam dimensions and tolerances
5. Amend product bagging direction and change product SPQ label to bottom left position on the large PE bag.

Schedule

2016, Sep, Taoglas will input New packaging rules.

Forecast Estimated Transition Date

September /2016

Illustration of Change (MA208.A.AB.007)
Old Drawing

| | | |
|--|----------------------------|-----|
|  | | REV |
| <small>This drawing and its inherent design concepts are property of Taoglas. Not to be copied or given to third parties without the written consent of Taoglas.</small> | | B |
| TITLE: | MA.208 Antenna Assembly | |
| | GPS 3M RG174 FAKRA C | |
| | Cellular 3M CFD200 FAKRA D | |
| PART NO.: | MA.208.A.AB.007 | |

| | Name | P/N | Material | Finish | QTY |
|---|--------------------|----------------|--------------|-------------|-----|
| 1 | Housing | 000111I030007A | ABS | Black | 1 |
| 2 | Closed Cell Foam | 001011I030007A | F 100 | Black | 1 |
| 3 | 3M Double Adhesive | 001011I030007A | 3M 9448 B | White LIner | 1 |
| 4 | Heat Shrink Tube | 001311F000007A | PE | Black | 1 |
| 5 | Clear Label | 001011I040007A | Coated Paper | Black | 1 |
| 6 | GPS Label | 001011F000007A | Coated Paper | Orange | 1 |
| 7 | Cellular Label | 001011F020007A | Coated Paper | Blue | 1 |
| 8 | Heat Shrink Tube | 001311F010007A | PE | Black | 1 |

| | Name | P/N | Spec | Finish | QTY |
|----|----------------|----------------|---------------|--------|-----|
| VV | Connector Type | 202313I000007A | FAKRA C | Blue | 1 |
| WW | Connector Type | 202413I000007A | FAKRA D | Violet | 1 |
| XX | Cable Length | | 3000mm ±120mm | | 2 |
| YY | Cable Type | 301313A000007A | RG174 | Black | 1 |
| ZZ | Cable Type | 301413A000007A | CFD 200 | Black | 1 |

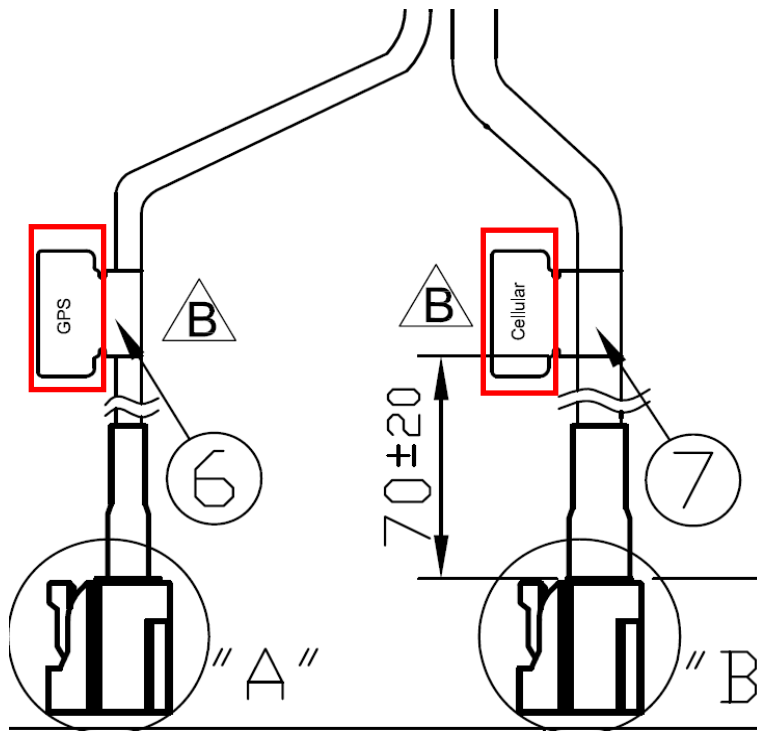
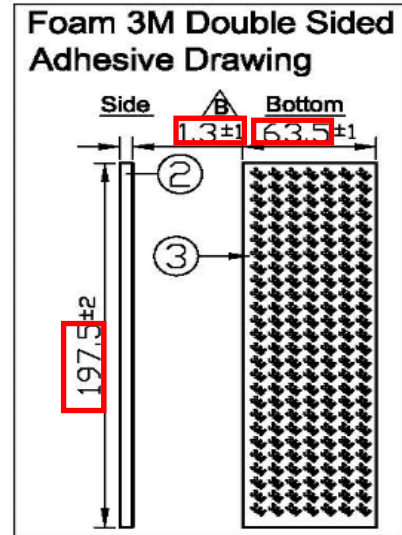

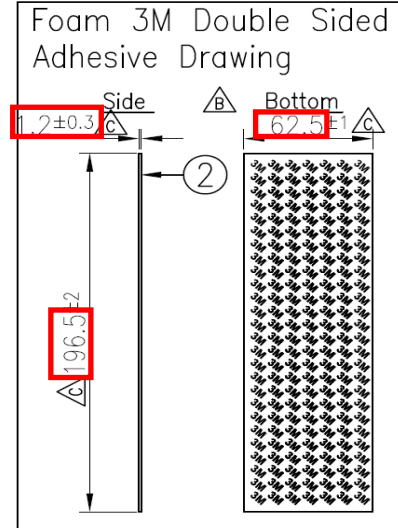

Illustration of Change (MA208.A.AB.007)
New Drawing

| | | |
|--|--|-----|
|  | | REV |
| <small>This drawing and its inherent design concepts are property of Taoglas. Not to be copied or given to third parties without the written consent of Taoglas.</small> | | C |
| TITLE. : MA.208 Antenna Assembly GPS 3M RG174 FAKRA C 2G/3G/4G 3M CFD200 FAKRA D | | |
| PART NO. : MA208 A.AB.007 | | |



| | Name | P/N | Material | Finish | QTY |
|---|-------------------------|----------------|--------------|------------|-----|
| 1 | Housing | 000111I030007A | ABS | Black | 1 |
| 2 | 3M Double Adhesive Foam | 001015I030000A | 3M 1600TB | Blue Liner | 1 |
| 3 | Heat Shrink Tube | 001315C030000A | PE | Black | 1 |
| 4 | Clear Label | 001011I040007A | Coated Paper | Black | 1 |
| 5 | GPS Label | 001011F000007A | PEPA | Orange | 1 |
| 6 | 2G/3G/4G Label | 001014A000007A | PEPA | White | 1 |
| 7 | Heat Shrink Tube | 001315C020000A | PE | Black | 1 |

| | Name | P/N | Spec | Finish | QTY |
|----|----------------|----------------|---------|--------|-----|
| W | Connector Type | 202313I000007A | FAKRA C | Blue | 1 |
| WW | Connector Type | 202413I000007A | FAKRA D | Violet | 1 |
| YY | Cable Type | 301315C000000A | RG174 | Black | 1 |
| ZZ | Cable Type | 301415C010000A | CFD 200 | Black | 1 |

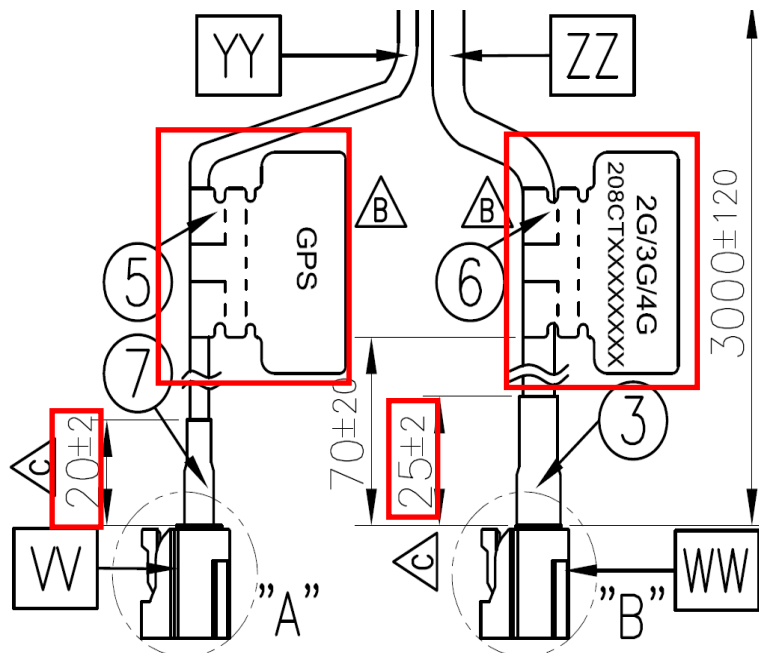
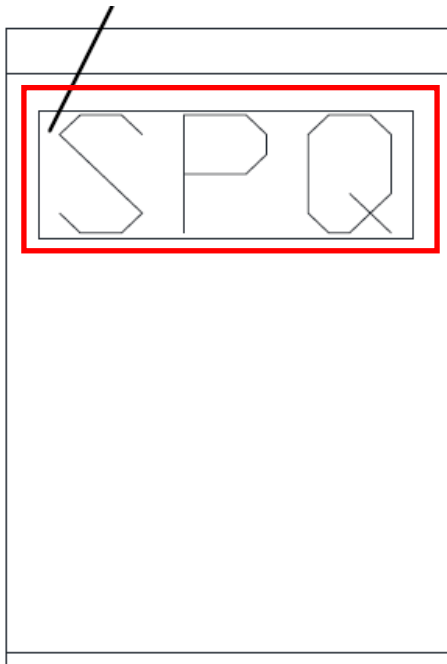
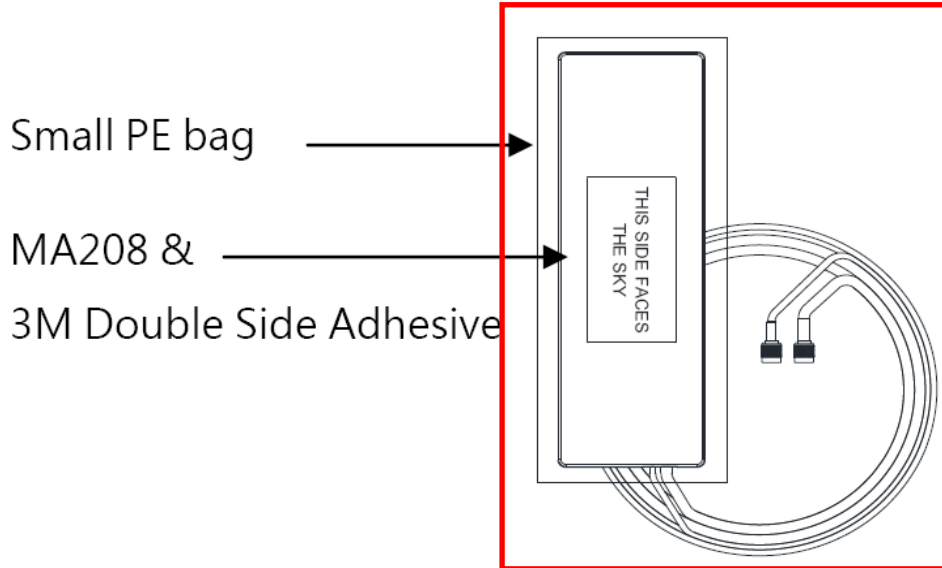
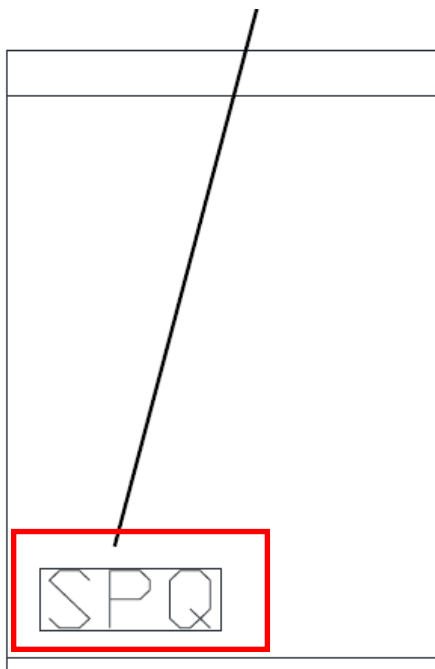
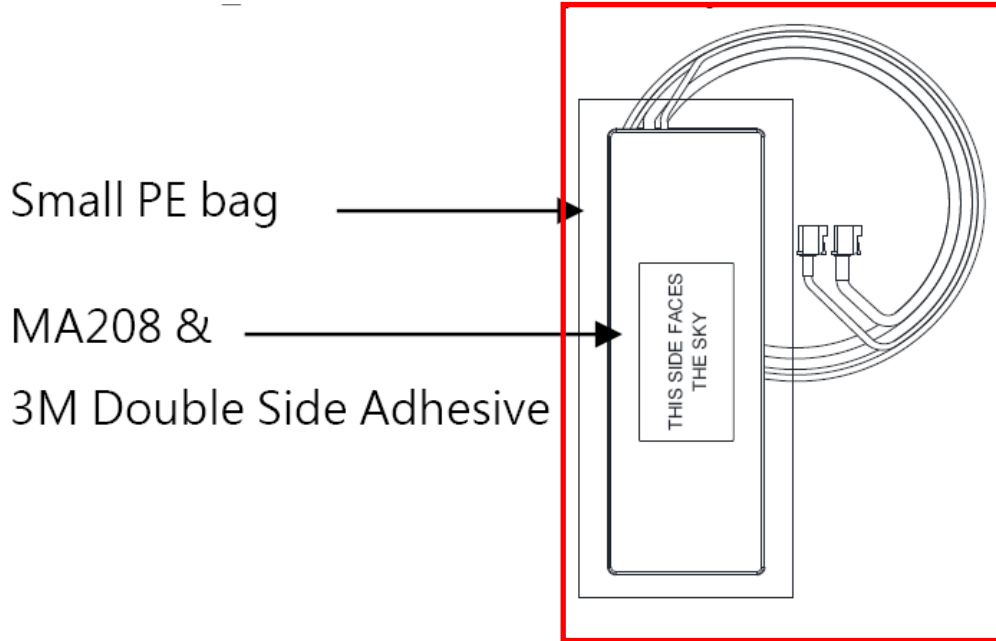

Illustration of Change (MA208.A.AB.007)
Old Package Rules



1PCS per big PE bag

**Illustration of Change (MA208.A.AB.007)
New Package Rules**



1PCS per big PE bag