

Data sheet | Item number: 890-929

h-distribution connector; 5-pole; Cod. A; 1 input; 2 outputs; outputs on one side; 2 locking levers; black

www.wago.com/890-929

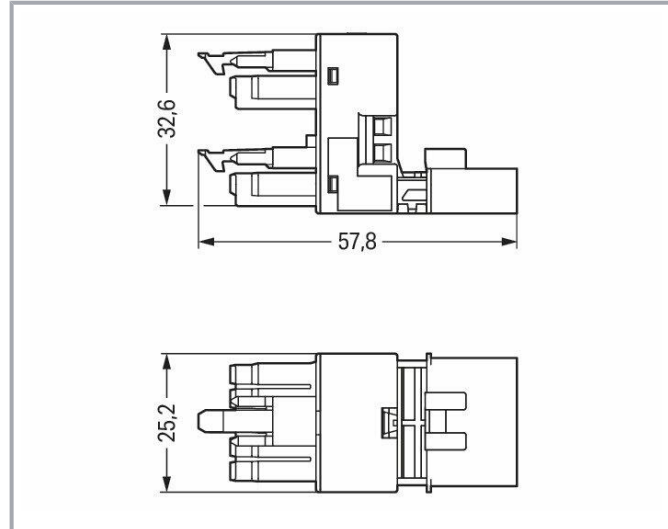
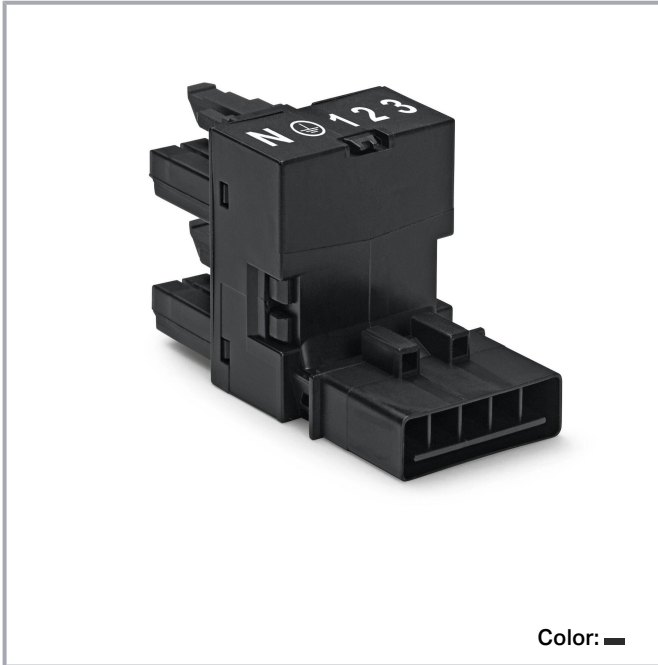

Item description

Distribution connector *WINSTA*® MINI rated current 13 A

For signal and power transmission: The *WINSTA*® MINI distribution connector with protection type IP20. Whether on PCBs, in control cabinets or for connecting lights – pluggable installation connectors from WAGO allow you to make connections according to an enormous variety of requirements in next to no time. For greater protection in electrical installations, the pluggable installation connector is equipped with mechanical protection against mismatching. General mains applications for almost any domain of use can be implemented with *WINSTA*® MINI pluggable installation connectors with A coding. *WINSTA*® MINI satisfies the demand for miniaturisation. Our smallest pluggable connection system is very good for lights, for instance, since due to LED technology, these offer less and less space for the connection technology.

WINSTA® MINI solutions for your electrical installation – protected against mismatching and maintenance-free

The *WINSTA*® Pluggable Connection System allows pluggable electrical installation. This significantly reduces the need for servicing and lowers costs. Choose quality and durability – the *WINSTA*® MINI pluggable installation connector with protection type IP20 from WAGO makes the electrical

Subject to changes. Please also observe the further product documentation!

WAGO GmbH & Co. KG
Hansastr. 27
32423 Minden
Phone: +49571 887-0 | Fax: +49571 887-169
Email: info.de@wago.com | Web: www.wago.com

Do you have any questions about our products?
We are always happy to take your call at +49 (571) 887-44222.



installation of electrical components substantially easier.

-
- protection against mismatching eliminates errors
- consistent IP40 protection
- for any mains application
- custom-engineered solutions
- rapid, structured electrical installation

Data

Electrical data

Ratings per IEC/EN

Ratings per	IEC/EN 60664-1
Nominal voltage (III/3)	400 V
Rated impulse voltage (III/3)	6 kV
Rated current	13 A
Legend (ratings)	(III / 3) ≙ Overvoltage category III / Pollution degree 3

Ratings per UL 1977

Note for the US market	Some versions may also be used for current interruption in accordance with the UL certificate in select applications with currents below 5 A and voltages up to 600 V. For further information, please contact your local sales office.
Rated voltage (UL 1977)	600 V
Rated current UL 1977	12 A

General

Note on contact resistance	approx. 1 mΩ of contact resistance approx. 0.25 mΩ contact transition plug/socket
----------------------------	--

Connection data

Total number of potentials	5
----------------------------	---

Connection 1

Pole number	5
-------------	---

Subject to changes. Please also observe the further product documentation!



Physical data

Pin spacing	4.4 mm / 0.173 inches
Width	25.2 mm / 0.992 inches
Height	32.65 mm / 1.285 inches
Depth	57.85 mm / 2.278 inches

Mechanical Data

Application	General mains applications
Coding	A
Variable coding	No
Marking	N \perp 1 2 3
Potential marking	N \perp 1 2 3
Mating force of a plug-in connection	approx. 20 ... 70 N (depending on pole number)
Retention force of a plug-in connection	When locked: > 80 N
Unmating force of a plug-in connection	Unlocked: approx. 20 ... 70 N (depending on pole number)
Number of mating cycles	200, without resistive load
Type of distribution box	h-distribution connector, outputs on one side
Protection type	IP20; IP40 when mated

Plug-in connection

Contact type (pluggable connector)	Socket/plug
Mismating protection	Yes
Note on mismating protection	All <i>WINSTA</i> [®] components are 100% protected against mismating when: a.) plugging different numbers of poles b.) plugging while rotated 180 c.) plugging while laterally staggered d.) plugging one pole
Locking lever	yes
Locking of plug-in connection	locking lever
Note on locking system	All connectors for mounted installations (snap-in versions for lighting fixtures or devices, all types of PCB and distribution connectors) are factory-equipped with locking levers to ensure plugs and sockets are securely locked. Additional locking levers are only required for flying leads (plug/socket).

Material Data

Note (material data)

Subject to changes. Please also observe the further product documentation!



Information on material specifications can be found here

Color	black
Material group	I
Insulation material	Polyamide (PA66)
Flammability class per UL94	V0
Contact material	Copper or copper alloy; surface-treated
Contact plating	Tin
Fire load	0.355 MJ
Weight	23 g

Environmental requirements

Processing temperature	-5 ... +40 °C
Continuous operating temperature	-35 ... +85 °C
Note on continuous operating temperature	Insulating parts for temperatures \leq 105 °C

Commercial data

Product Group	20 (Winsta)
eCl@ss 10.0	27-44-06-03
eCl@ss 9.0	27-44-06-03
ETIM 8.0	EC002567
ETIM 7.0	EC002567
PU (SPU)	50 pcs
Packaging type	box
Country of origin	DE
GTIN	4050821255116
Customs tariff number	85366990990

Environmental Product Compliance

RoHS Compliance Status	Compliant, No Exemption
------------------------	-------------------------

Approvals / Certificates

General approvals

Logo	Approval	Additional Approval Text	Certificate name
	CCA DEKRA Certification B.V.	IEC 61535	NL-85020

Subject to changes. Please also observe the further product documentation!



CCA
DEKRA Certification B.V.

EN 61535

71-
123231





cURus
Underwriters Laboratories Inc.



UL 1977

E45171





Declarations of conformity and manufacturer's declarations

Logo	Approval	Additional Approval Text	Certificate name
	EU-Declaration of Conformity WAGO GmbH & Co. KG	-	-
	UK-Declaration of Conformity WAGO GmbH & Co. KG	-	-

Approvals for marine applications

Logo	Approval	Additional Approval Text	Certificate name
	ABS American Bureau of Shipping	Steel Vessel Rules	19- HG1869855- PDA
	DNV GL Det Norske Veritas, Germanischer Lloyd	-	TAE00001Z6



Counterpart

	Item no.890-105 Socket; with strain relief housing; 5-pole; Cod. A; 1,50 mm ² ; black	www.wago.com/890-105
	Item no.890-115 Plug; with strain relief housing; 5-pole; 1,50 mm ² ; black	www.wago.com/890-115
	Item no.890-205 Socket; 5-pole; Cod. A; 1,50 mm ² ; black	www.wago.com/890-205
	Item no.890-215 Plug; 5-pole; Cod. A; 1,50 mm ² ; black	www.wago.com/890-215

Subject to changes. Please also observe the further product documentation!

WAGO GmbH & Co. KG
Hansastr. 27
32423 Minden
Phone: +49571 887-0 | Fax: +49571 887-169
Email: info.de@wago.com | Web: www.wago.com



Do you have any questions about our products?
We are always happy to take your call at +49 (571) 887-44222.

	Item no.891-8995/006-101 pre-assembled interconnecting cable; Eca; Socket/plug; 5-pole; Cod. A; H05VV-F 5G 1.5 mm ² ; 1 m; 1,50 mm ² ; black	www.wago.com/891-8995/006-101
	Item no.891-8995/106-101 pre-assembled connecting cable; Eca; Socket/open-ended; 5-pole; Cod. A; H05VV-F 5G 1.5 mm ² ; 1 m; 1,50 mm ² ; black	www.wago.com/891-8995/106-101
	Item no.891-8995/206-101 pre-assembled connecting cable; Eca; Plug/open-ended; 5-pole; Cod. A; H05VV-F 5G 1.5 mm ² ; 1 m; 1,50 mm ² ; black	www.wago.com/891-8995/206-101

Required accessories

Mounting

Mounting accessories

	Item no.: 890-625 Mounting plate; 5-pole; for distribution connectors; Plastic; black	www.wago.com/890-625
	Item no.: 890-675 Mounting plate; 5-pole; for distribution connectors; Plastic; white	www.wago.com/890-675

Downloads

Documentation

Bid Text

890-929 X81 - Datei	2019 Feb 19	xml 2.8 kB	Download
890-929 doc - Datei	2014 Dec 1	doc 23.0 kB	Download

CAD/CAE-Data

CAD data

2D/3D Models 890-929	URL	Download
----------------------	-----	----------

CAE data

WSCAD Universe 890-929	URL	Download
ZUKEN Portal 890-929	URL	Download

Subject to changes. Please also observe the further product documentation!

Environmental Product Compliance

Compliance Search

Environmental Product Compliance 890-929

URL

Download

h-distribution connector; 5-pole; Cod. A; 1 input; 2 outputs; outputs on one side; 2 locking levers; black

Installation Notes

Installation

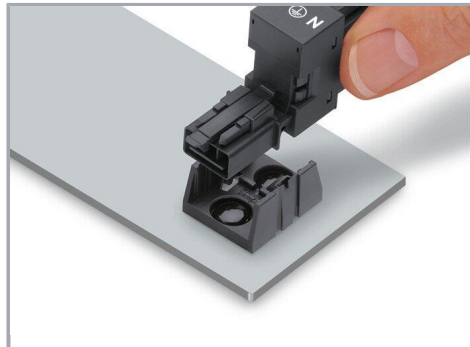

Secure the mounting plate via pins.

Product family

WINSTA® MINI

[Show all products from the family](#)

Subject to changes. Please also observe the further product documentation!

WAGO GmbH & Co. KG

Hansastr. 27

32423 Minden

Phone: +49571 887-0 | Fax: +49571 887-169

Email: info.de@wago.com | Web: www.wago.com

Do you have any questions about our products?

We are always happy to take your call at +49 (571) 887-44222.