

---

**M24LRxx/CR95HF application software installation guide**

---

**Introduction**

This user manual describes the procedures to install the different software drivers required to use the DEVKIT-M24LR-A development kit, the DEMOKIT-M24LR-A, the DEMO-CR95HF-A, and the M24LR-DISCOVERY demonstration kits. These drivers are included in the STSW-M24LR011 application software.

The STSW-M24LR011 together with the development and demonstration kits allow to develop an application based on any M24LRxx dual interface EEPROM.

The document also gives a brief description of the development, demonstration and starter kits, and explains how to connect the RF and I<sup>2</sup>C readers to your computer.

# Contents

- 1        Installing the setup.exe ..... 6**
  
- 2        Installing the drivers specific to the development kit  
         and demonstration kit ..... 11**
  - 2.1    Step1: Installing the drivers for the medium-range RF reader .....11
  - 2.2    Step2: Installing the drivers for the I<sup>2</sup>C serial bus reader  
         (serial EEPROM USB reader) ..... 22
  - 2.3    Trouble shooting ..... 30
    - 2.3.1    RF reader driver ..... 30
  
- 3        Tool kit descriptions ..... 32**
  - 3.1    M24LRXX development kit ..... 32
    - 3.1.1    Ordering information ..... 32
    - 3.1.2    Development kit package ..... 32
  - 3.2    M24LR64-R demonstration kit ..... 34
    - 3.2.1    Ordering information ..... 34
    - 3.2.2    Demonstration kit package ..... 34
  - 3.3    M24LR64-R starter kit ..... 36
    - 3.3.1    Ordering information ..... 36
    - 3.3.2    Starter kit package ..... 36
  - 3.4    DEMO-CR95HF-A ..... 38
    - 3.4.1    Ordering information ..... 38
    - 3.4.2    DEMO-CR95HF-A ..... 38
  - 3.5    Connecting the readers and cables to your computer ..... 39
  - 3.6    Web support and references ..... 40
  
- 4        Revision history ..... 42**

## List of tables

Table 1. Document revision history ..... 42

## List of figures

Figure 1.	Setup - M24LRxx Application Software window . . . . .	6
Figure 2.	License Agreement window . . . . .	7
Figure 3.	Installation path. . . . .	7
Figure 4.	Creating the program shortcuts . . . . .	8
Figure 5.	Location of the application icon . . . . .	8
Figure 6.	Installing the user interface. . . . .	9
Figure 7.	Software README . . . . .	9
Figure 8.	Software installation completion . . . . .	10
Figure 9.	Messages that pop up when the RF reader is connected to the computer . . . . .	11
Figure 10.	Welcome to the Found New Hardware Wizard window . . . . .	12
Figure 11.	“Install from a list or specific location (Advanced)” . . . . .	12
Figure 12.	Search and installation options. . . . .	13
Figure 13.	Hardware type . . . . .	13
Figure 14.	Selecting the device driver . . . . .	14
Figure 15.	Install from disk. . . . .	14
Figure 16.	Locate file . . . . .	15
Figure 17.	Select the <i>obidusb.inf</i> file and Open . . . . .	15
Figure 18.	Click “OK” to return to initial window. . . . .	16
Figure 19.	The driver has been selected . . . . .	16
Figure 20.	Driver installation process. . . . .	17
Figure 21.	Installation complete . . . . .	17
Figure 22.	Start > Settings > Control Panel . . . . .	18
Figure 23.	System Properties window . . . . .	19
Figure 24.	Hardware tab . . . . .	20
Figure 25.	Device Manager window. . . . .	21
Figure 26.	Popup message . . . . .	22
Figure 27.	Welcome to the Found New Hardware Wizard window . . . . .	22
Figure 28.	“Install from a list or specific location (Advanced)” . . . . .	23
Figure 29.	Search and installation options. . . . .	23
Figure 30.	Selecting the device driver to install . . . . .	24
Figure 31.	Browsing your computer. . . . .	24
Figure 32.	File location. . . . .	25
Figure 33.	Instal from disk . . . . .	25
Figure 34.	EEPROM USB drivers to be installed. . . . .	26
Figure 35.	Software installation . . . . .	27
Figure 36.	Installation complete . . . . .	28
Figure 37.	Device Manager window. . . . .	29
Figure 38.	Example where OBID is not correctly installed. . . . .	30
Figure 39.	Update Driver..... . . . .	31
Figure 40.	RF reader . . . . .	32
Figure 41.	External antenna. . . . .	32
Figure 42.	I <sup>2</sup> C bus reader (serial EEPROM USB reader). . . . .	33
Figure 43.	I <sup>2</sup> C bus cable. . . . .	33
Figure 44.	ANT1-M24LR-A reference antenna . . . . .	33
Figure 45.	ANT2-M24LR-A reference antenna . . . . .	34
Figure 46.	M24LR64-R in SO8 package . . . . .	34
Figure 47.	RF reader . . . . .	35
Figure 48.	PRIM2-M24LR-A reference antenna . . . . .	35

---

Figure 49.	STM32-PRIMER2 .....	35
Figure 50.	Connecting your reference antenna to your STM32-PRIMER2 .....	36
Figure 51.	I <sup>2</sup> C & RF reader .....	37
Figure 52.	ANT1-M24LR-A reference antenna .....	37
Figure 53.	ANT2-M24LR-A reference antenna .....	38
Figure 54.	M24LR64-R in SO8 package .....	38
Figure 55.	DEMO-CR95HF-A demonstration kit .....	39
Figure 56.	External connector pinout of the serial I <sup>2</sup> C bus reader .....	39
Figure 57.	External connector pinout of the M24LR64-R tag .....	40
Figure 58.	Connecting the RF and I <sup>2</sup> C bus readers .....	40

# 1 Installing the *setup.exe*

Download the STSW-M24LR011 firmware from <http://www.st.com>. The zip file contains the *setup.exe* which can be used to install on your computer all the drivers required by the *M24LRxx\_Application\_Software*.

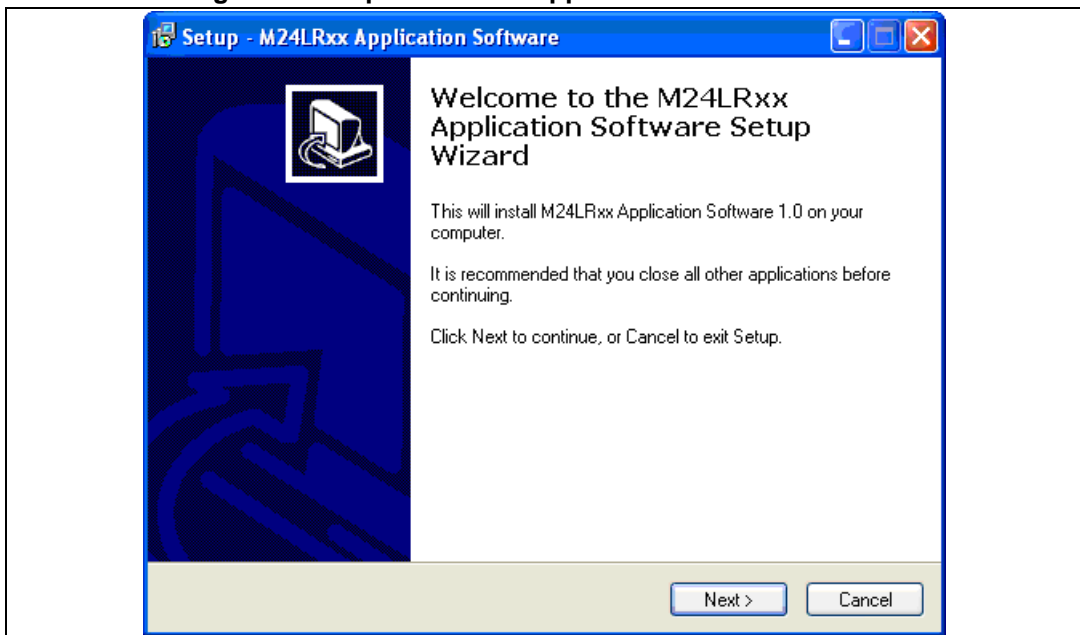
This *setup.exe* file has to be installed for the development, demonstration and starter kits.

**Caution:** Please do NOT connect the USB cable(s) to your computer now.

To install the *setup.exe*, use the sequence below:

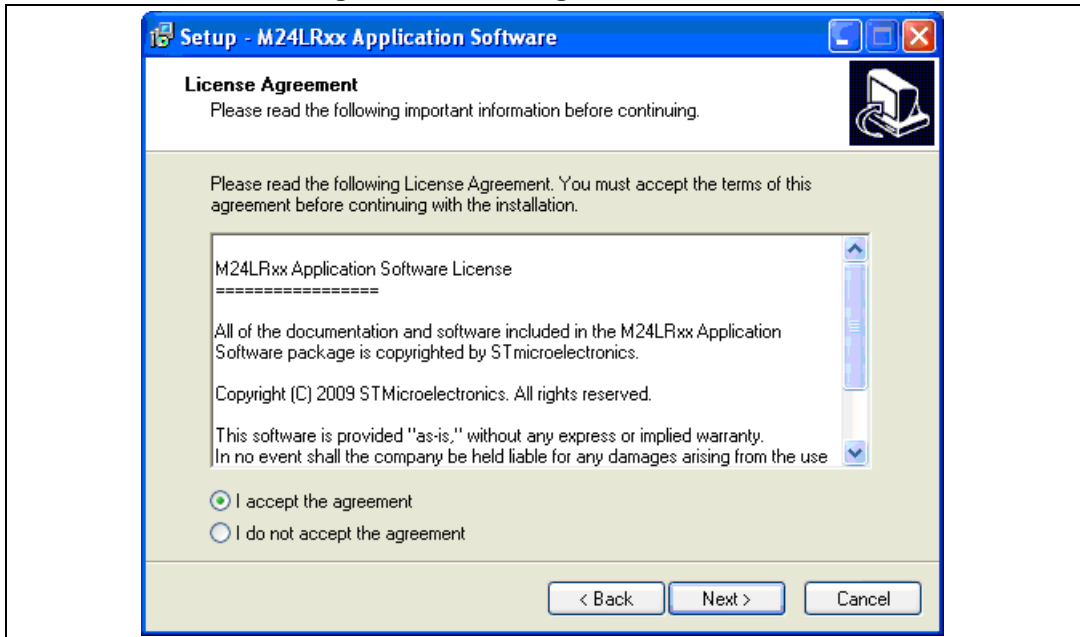
1. Double click on the *setup.exe* file. The window shown in *Figure 1* appears. Click on "Next >" to continue.

**Figure 1. Setup - M24LRxx Application Software window**



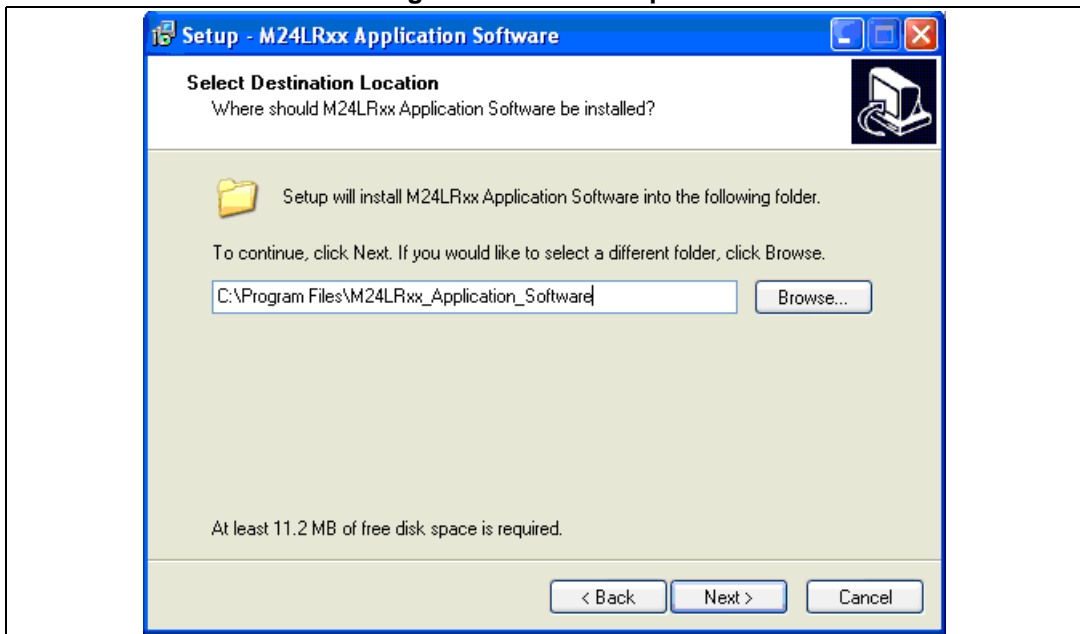
2. Read the License Agreement and click on "I accept the agreement" if you agree (see [Figure 2](#)).

**Figure 2. License Agreement window**



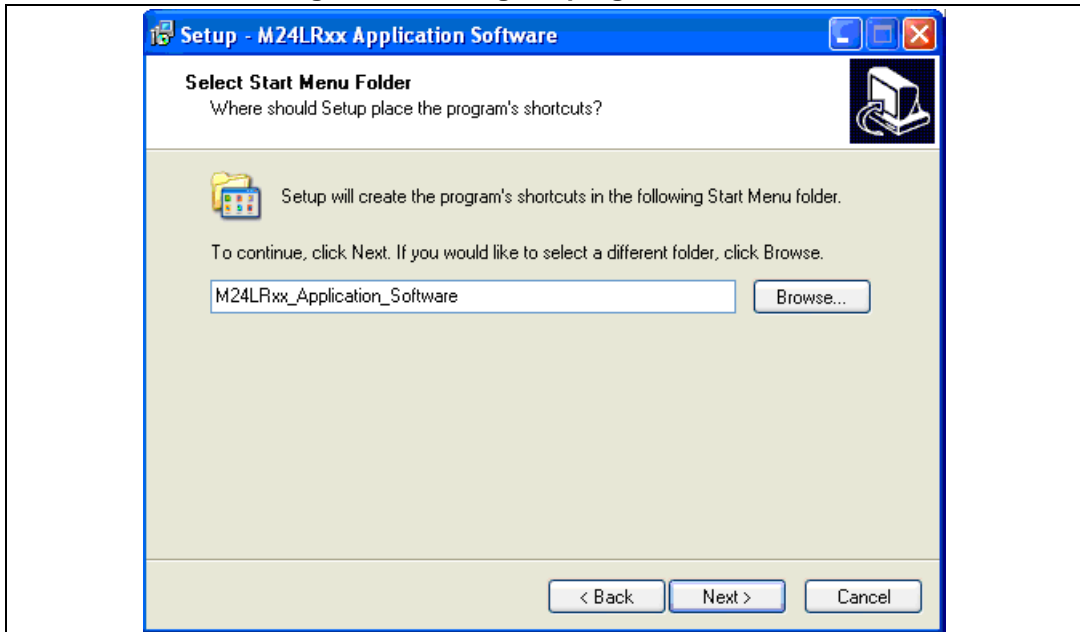
3. Browse your computer to select the path where you want to install this software (see [Figure 3](#)). Then click on Next.

**Figure 3. Installation path**



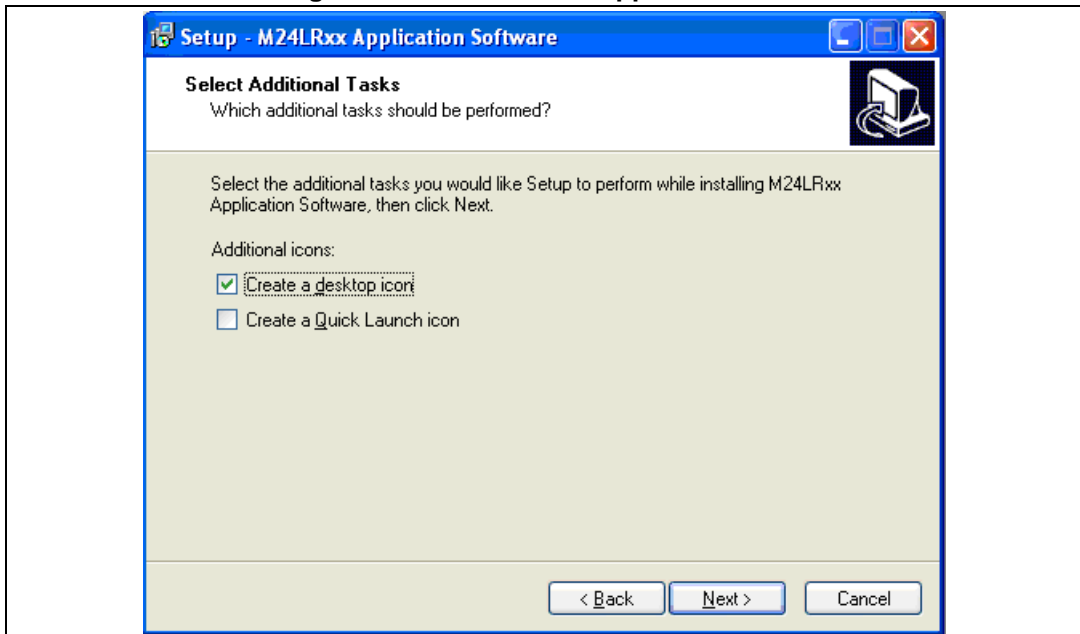
4. A new window opens to create the application shortcuts. By default, select "Next", otherwise, browse your computer (see [Figure 4](#)).

**Figure 4. Creating the program shortcuts**



5. Define the type of icon you want then click "Next" (see [Figure 5](#)).

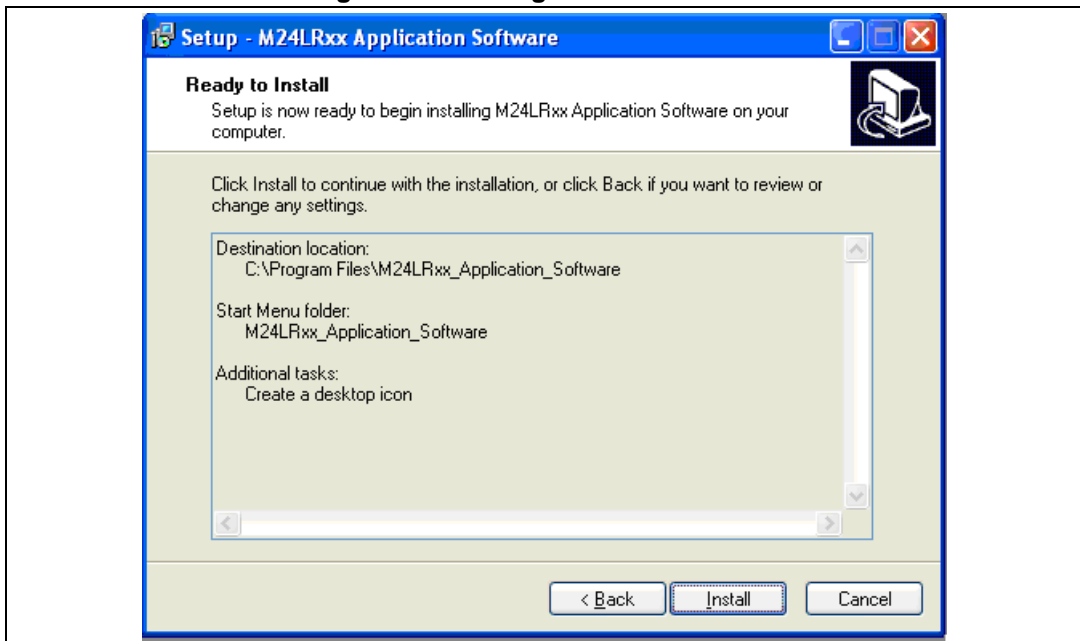
**Figure 5. Location of the application icon**





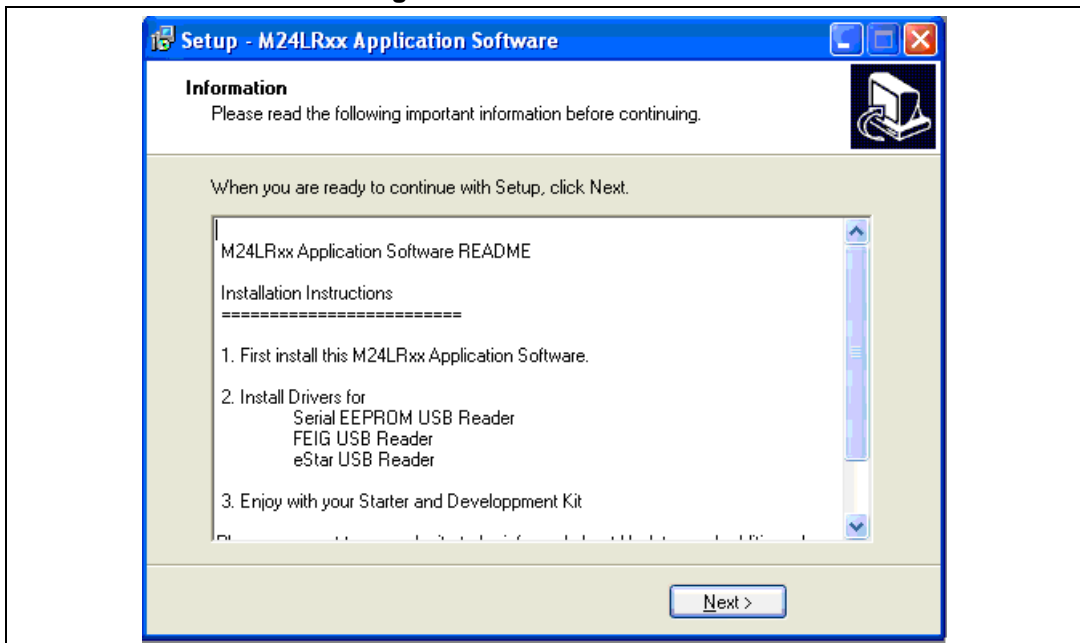
- 6. Install the user Interface software of the M24LRXX tools (see [Figure 6](#)).

**Figure 6. Installing the user interface**



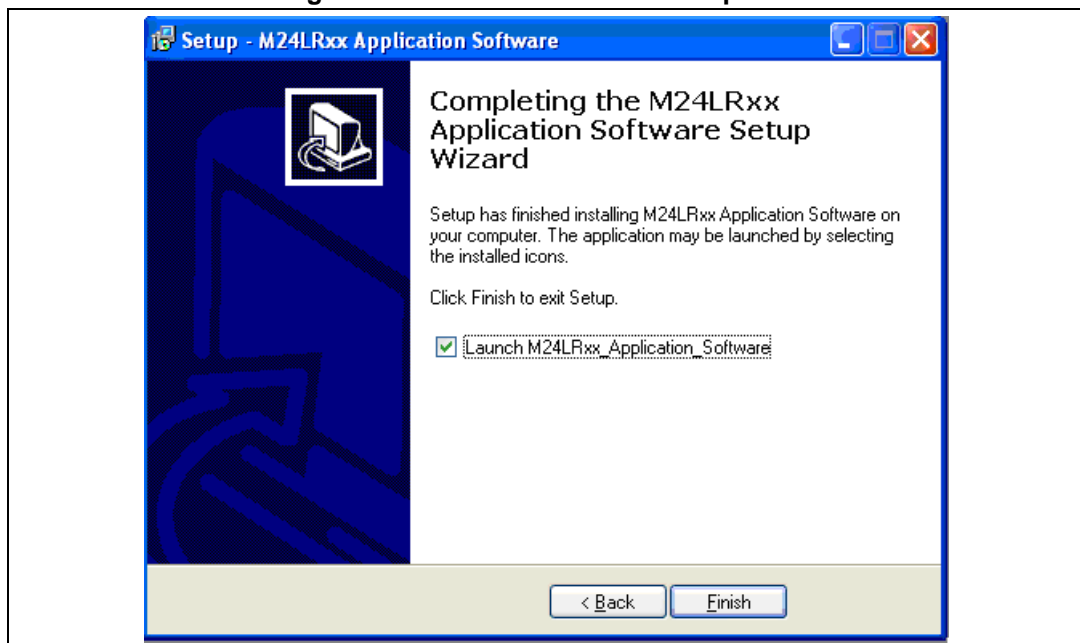
- 7. The README information of the software is then displayed as shown in [Figure 7](#). Please read it carefully.

**Figure 7. Software README**



8. The first step of the installation process is over!

**Figure 8. Software installation completion**



#### What is the status now?

- The *M24LRxx\_Application\_Software* is now installed on your computer
- You still have to install the drivers as described in [Section 2: Installing the drivers specific to the development kit and demonstration kit](#).

## 2 Installing the drivers specific to the development kit and demonstration kit

This section describes how to install the drivers allowing your computer to interface the RF reader and the I<sup>2</sup>C serial bus reader through the USB ports.

*Note:* The starter kit does not need any specific installation driver.

### 2.1 Step1: Installing the drivers for the medium-range RF reader

You should first power up the RF reader and connect its USB cable to your computer. The RF reader is then detected, and the popup messages shown in [Figure 9](#) appear.

**Figure 9. Messages that pop up when the RF reader is connected to the computer**



The “Found New Hardware Wizard” then starts up and you should follow the procedure described below:

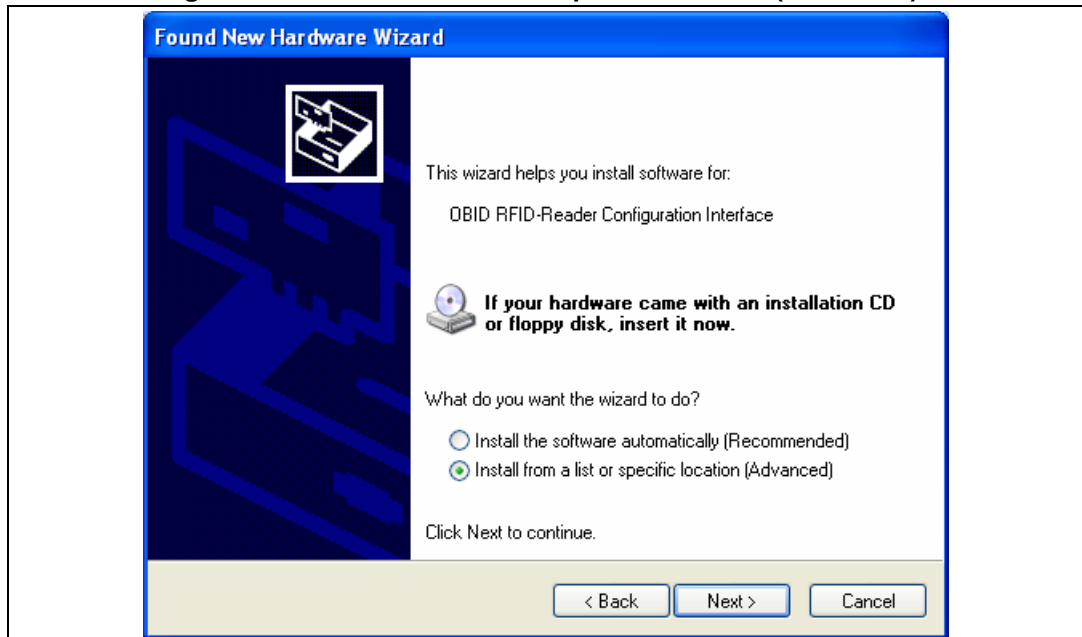
1. The “Welcome to the Found New Hardware Wizard” window opens (see *Figure 10*). Select “Yes, this time only”, and click on “Next >”.

**Figure 10. Welcome to the Found New Hardware Wizard window**



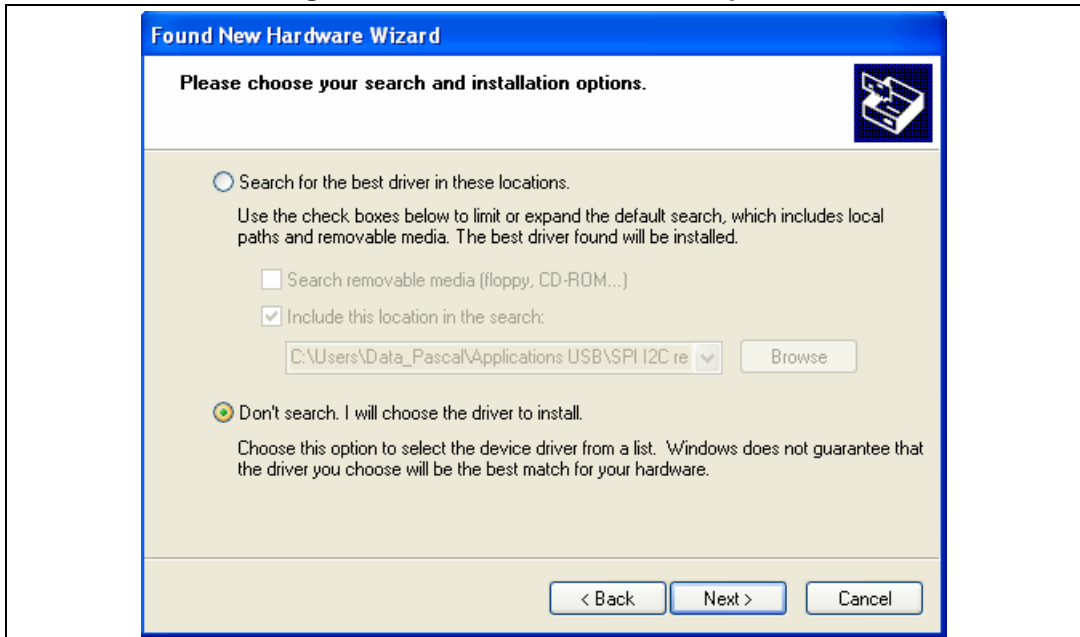
2. In the next window (see *Figure 11*), select “Install from a list or specific location (Advanced)”, and click on “Next >”.

**Figure 11. “Install from a list or specific location (Advanced)”**



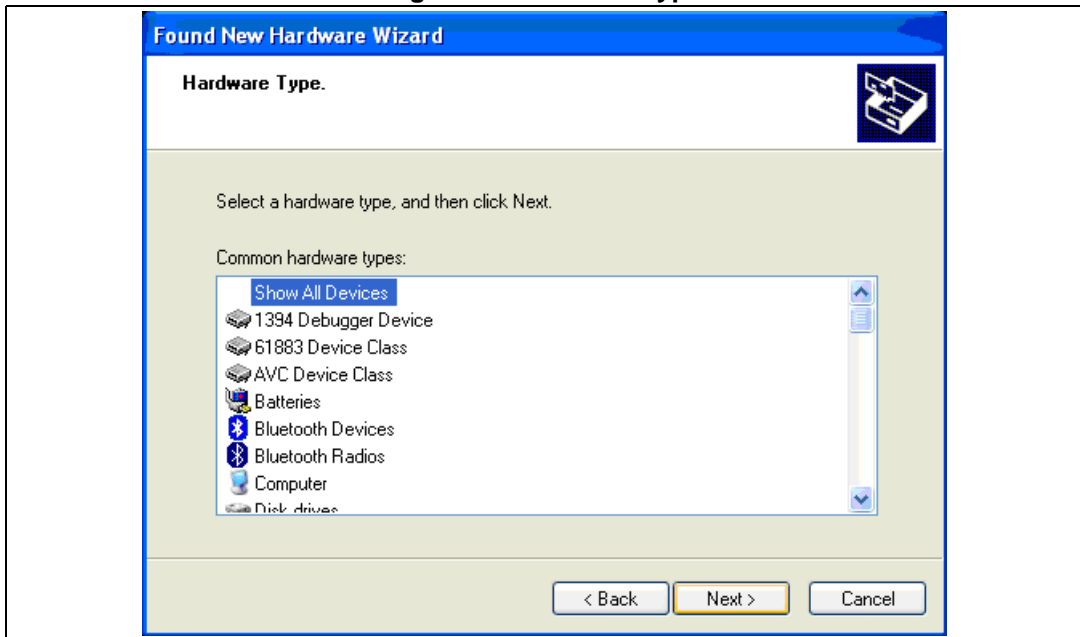
- As shown in *Figure 12*, select “Don’t search. I will choose the driver to install.”, and click on “Next >”.

**Figure 12. Search and installation options**



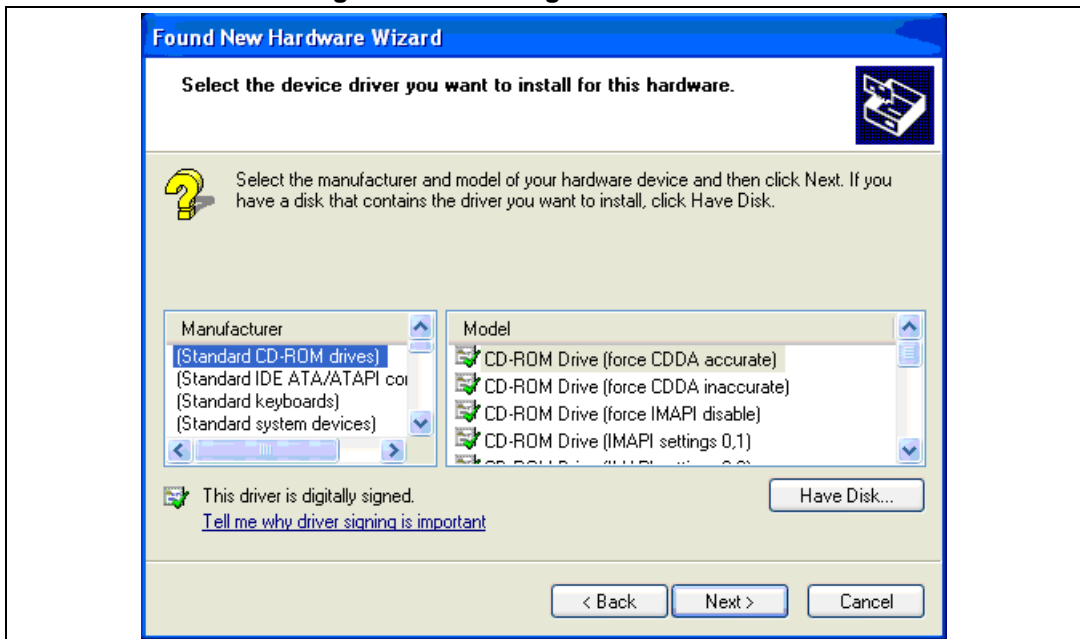
- Then, like in *Figure 13*, select “Show All Devices”, and click on “Next >”.

**Figure 13. Hardware type**



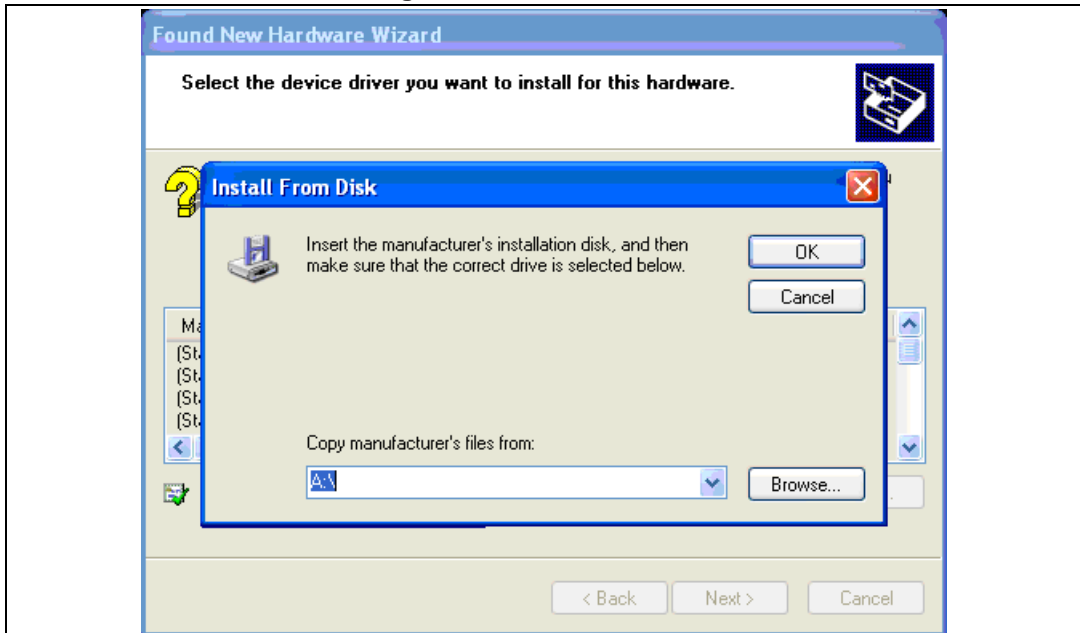
5. In the next window (see *Figure 14*), click on “Have Disk...”.

**Figure 14. Selecting the device driver**



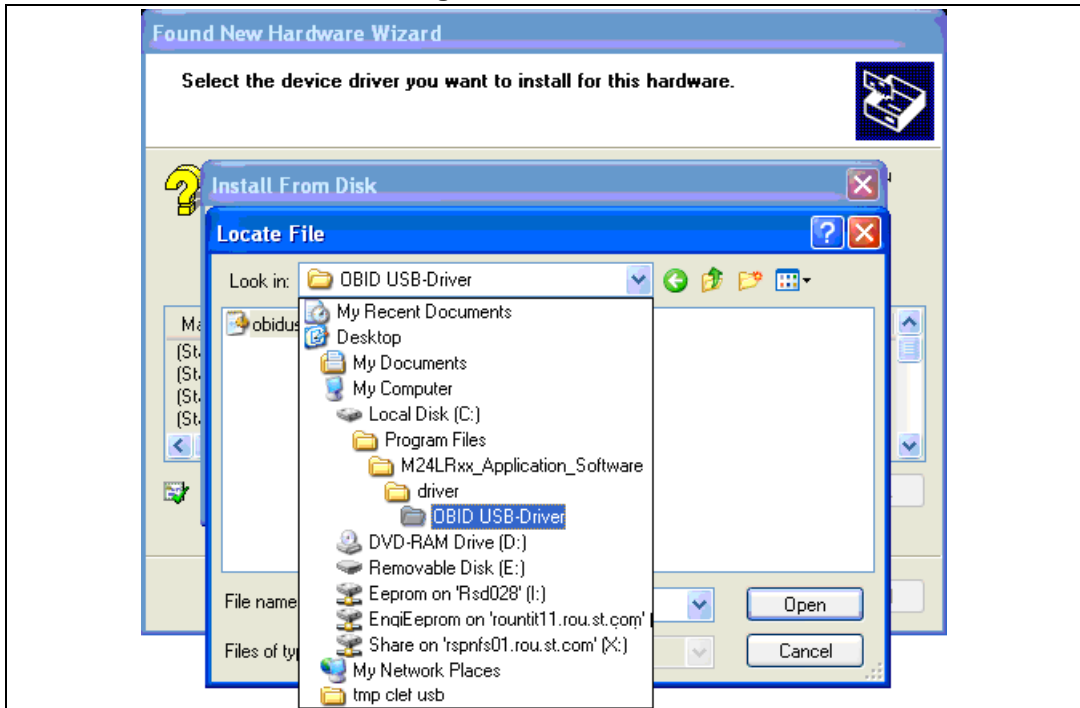
6. Then, click on “Browse...” to locate the file (see *Figure 15* and *Figure 16*).

**Figure 15. Install from disk**



7. Select the *ObidUsb.inf* file in the install directory. The default path is:  
*C:/Program File/M24LRxx\_Application\_Software/Driver/OBID USB driver/*

Figure 16. Locate file



Click on "Open" (see [Figure 17](#)) and then on "OK" (see [Figure 18](#))

Figure 17. Select the *obidusb.inf* file and Open

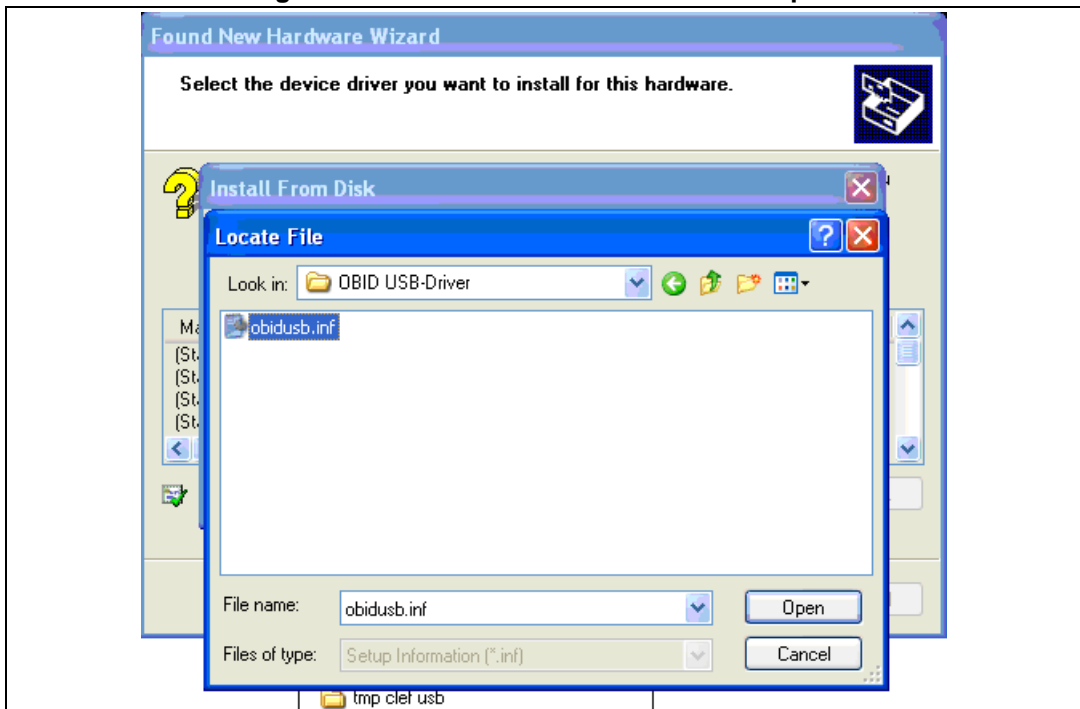
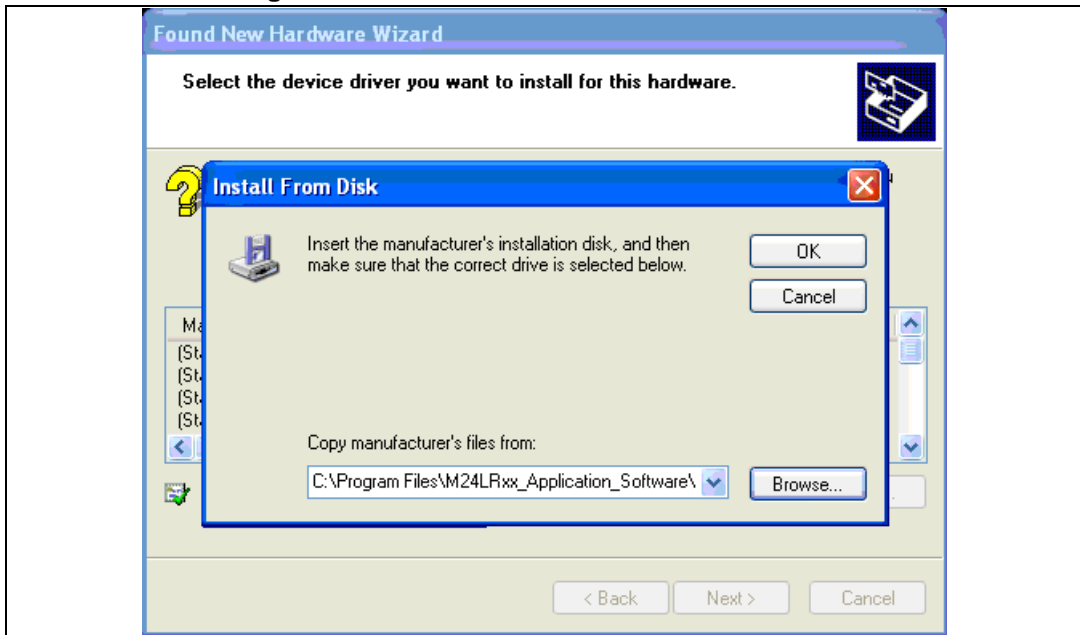


Figure 18. Click “OK” to return to initial window



- 8. The window now displays the OBID drivers that have been selected (see *Figure 19*). Click on “Next >” to install the driver (see *Figure 20*).

Figure 19. The driver has been selected

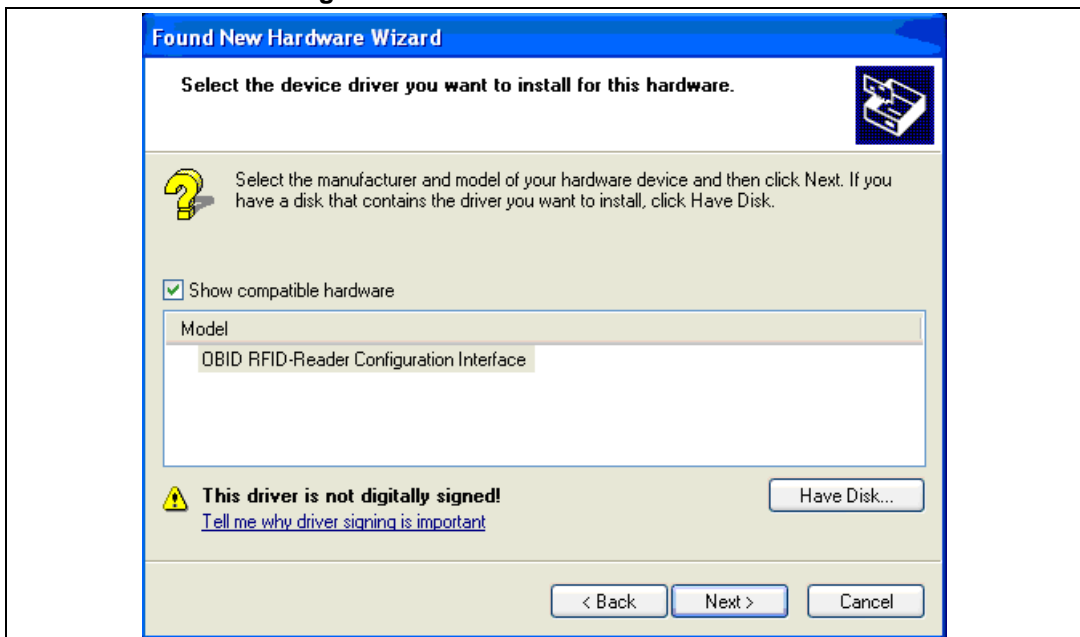
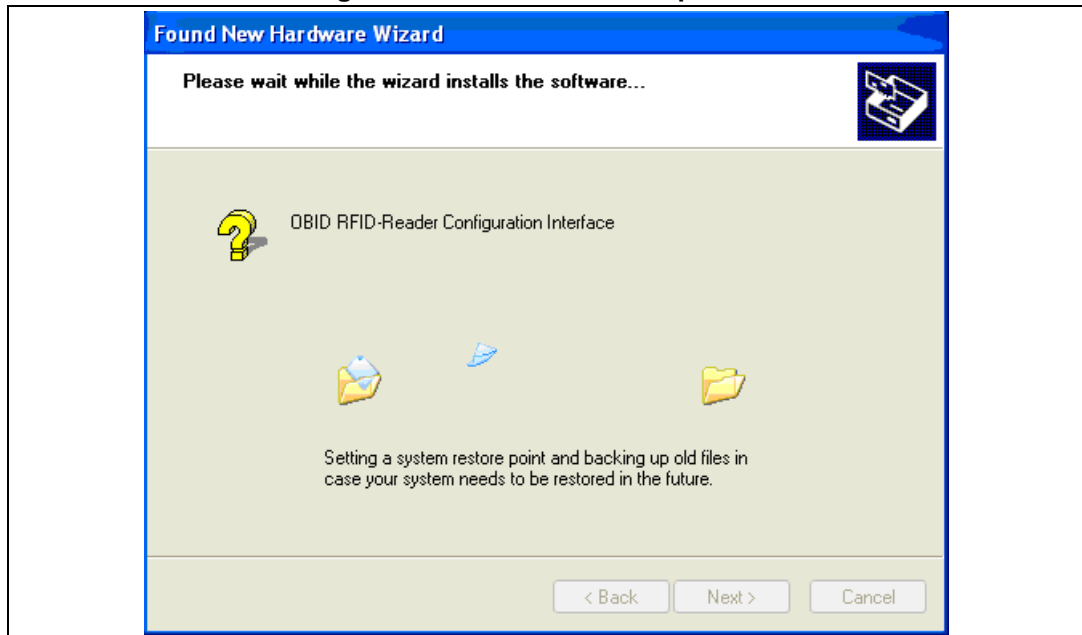


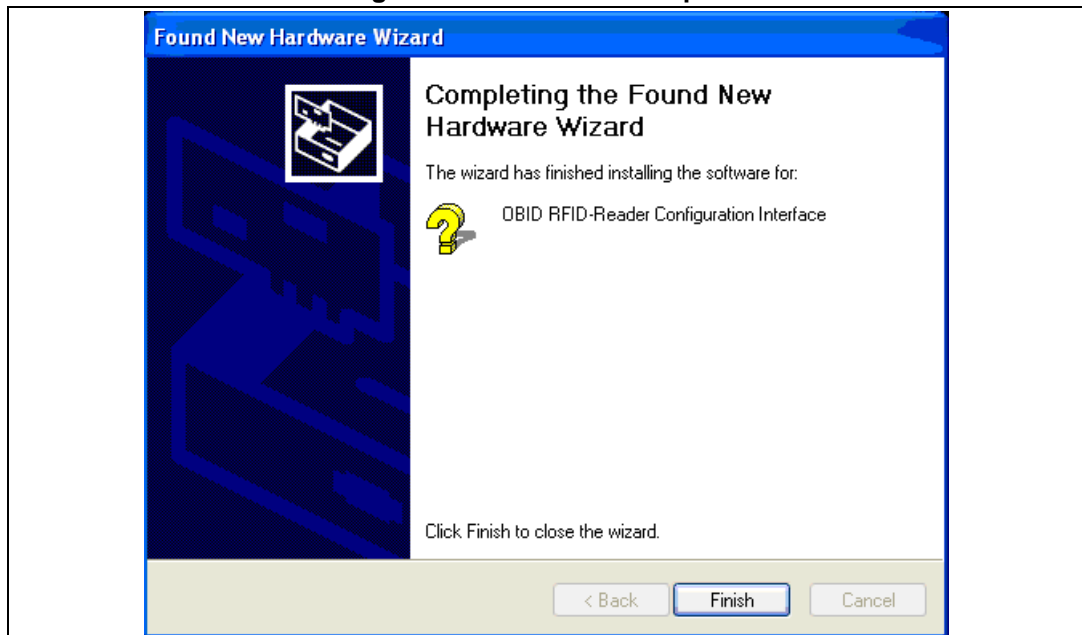


Figure 20. Driver installation process



- 9. When the installation is complete, click on "Finish" (see [Figure 21](#)).

Figure 21. Installation complete



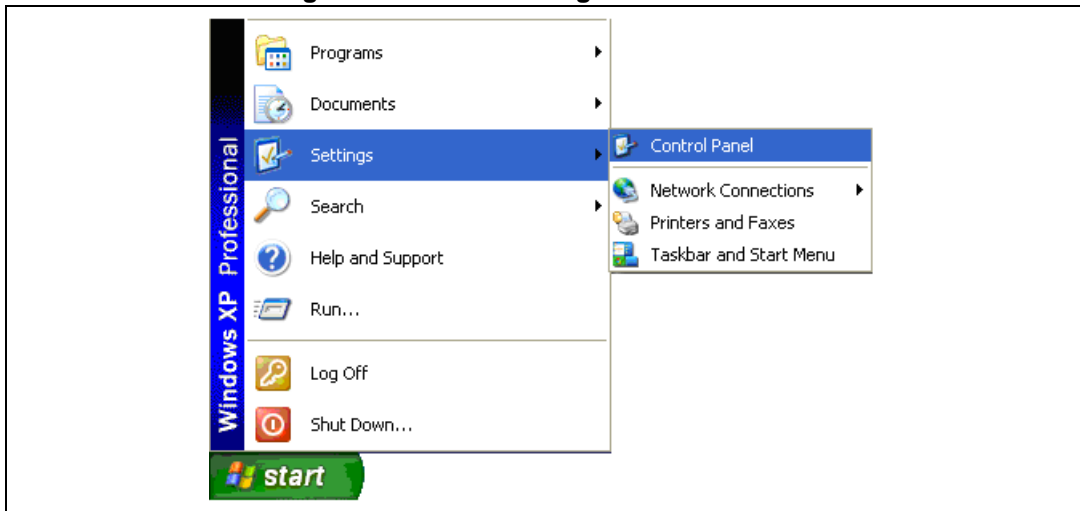
The drivers allowing your computer to interface the RF reader are now installed. The following step is described in [Section 2.2: Step2: Installing the drivers for the I<sup>2</sup>C serial bus reader \(serial EEPROM USB reader\)](#).

### Advanced information

You can verify that the medium-range RF reader drivers are correctly installed. OBID USB Devices should be detected when the medium-range RF reader is plugged into your computer's USB port.

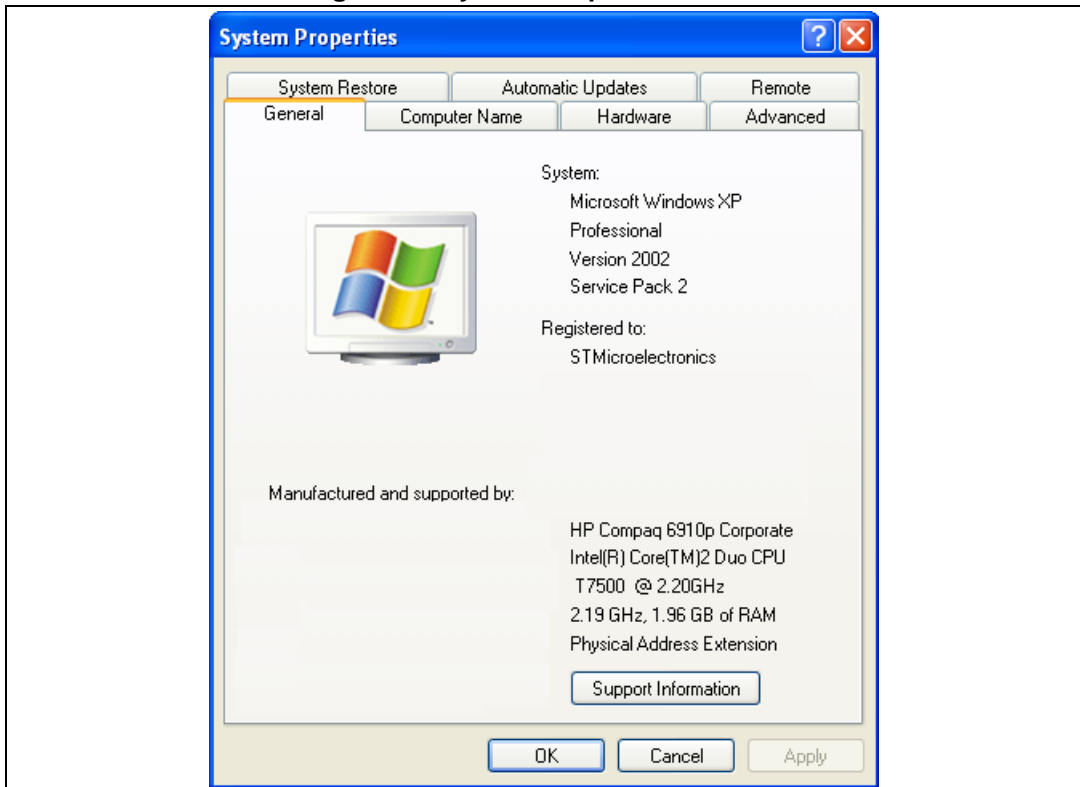
To check that the drivers are correctly installed, go to Start/Settings/Control Panel as shown in [Figure 22](#).

Figure 22. Start > Settings > Control Panel



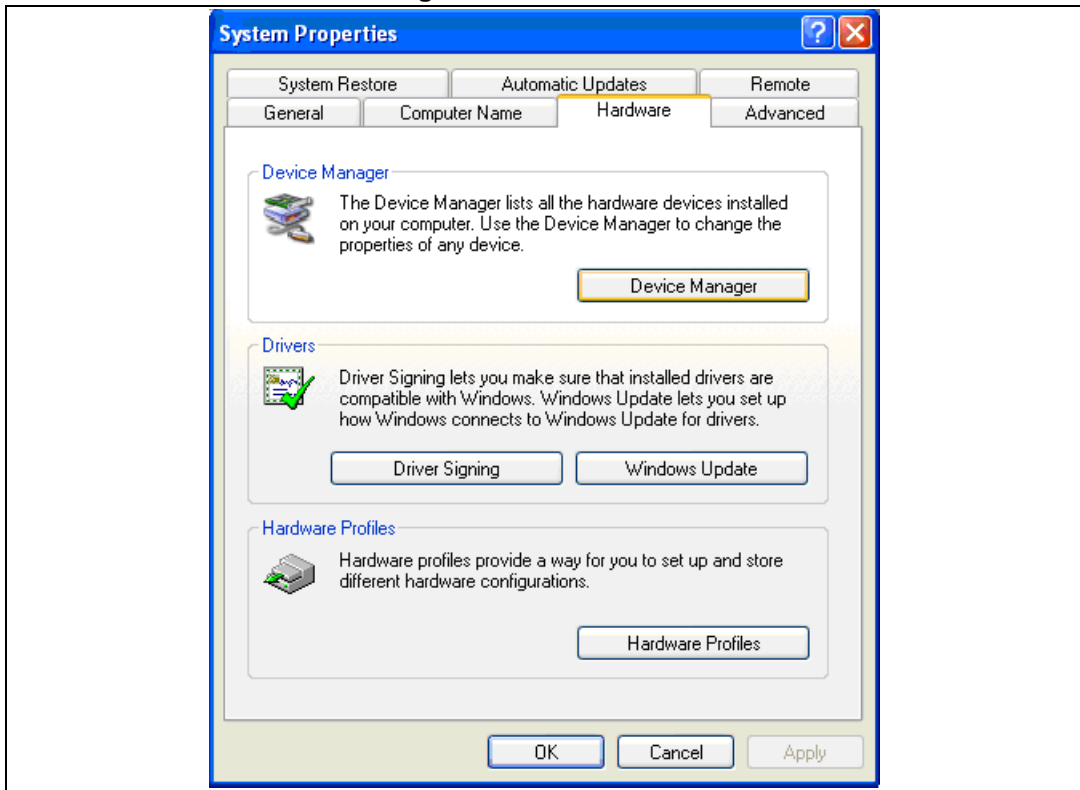
In the Control Panel folder, double click on System. This causes the System Properties window to open (see [Figure 23](#)).

Figure 23. System Properties window



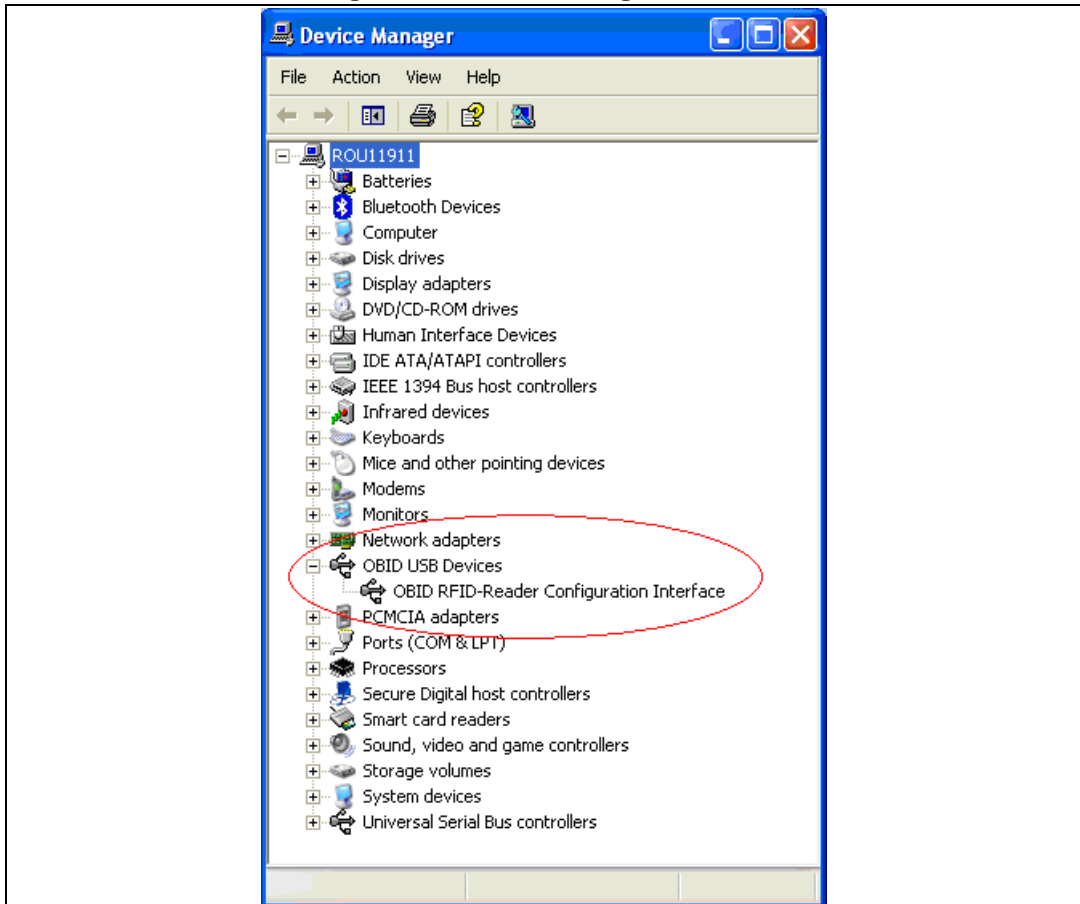
Then click on the Hardware tab and then on Device Manager as shown in [Figure 24](#).

Figure 24. Hardware tab



The Device Manager window opens (see [Figure 25](#)). “OBID USB Devices” should be present.

Figure 25. Device Manager window

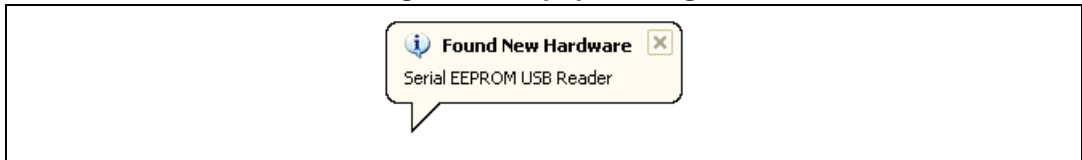


## 2.2 Step2: Installing the drivers for the I<sup>2</sup>C serial bus reader (serial EEPROM USB reader)

Note that if you do not have to use the serial EEPROM USB reader, you do not need to install these drivers.

To install the drivers: first, connect the USB cable between the I<sup>2</sup>C serial bus reader and your computer. The I<sup>2</sup>C bus reader is then detected and the following popup message appears (see *Figure 26*).

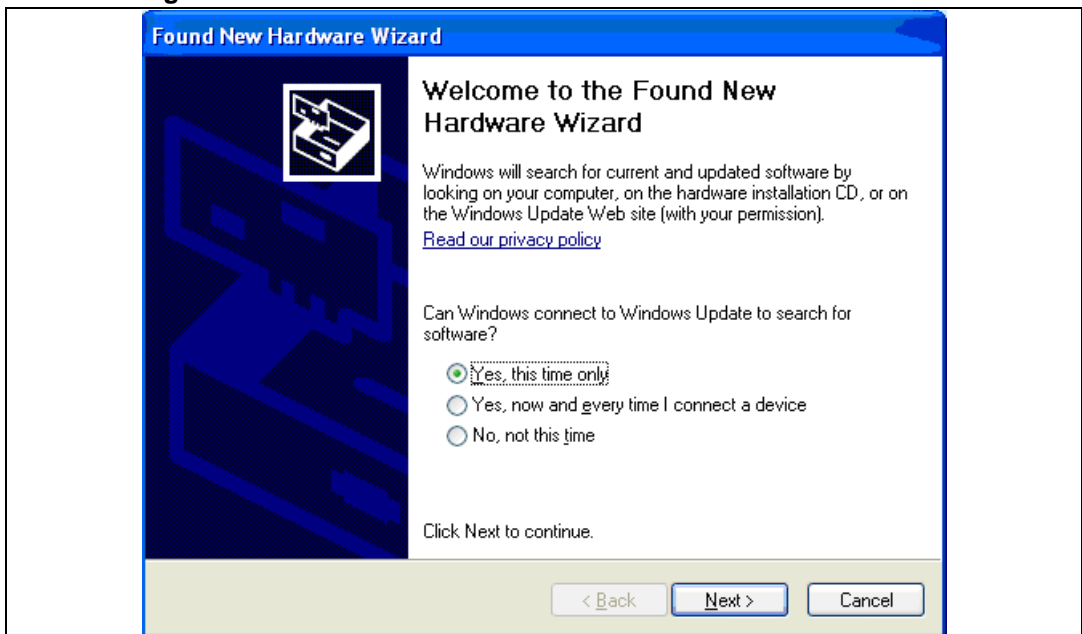
Figure 26. Popup message



The “Found New Hardware Wizard” then starts up and you should follow the procedure described below:

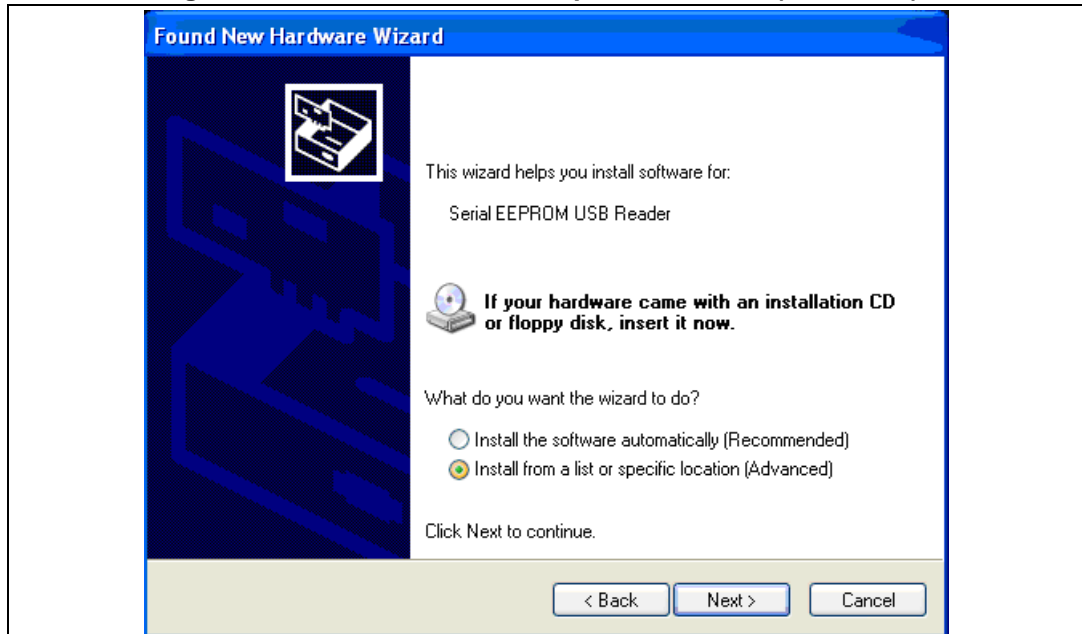
10. The “Welcome to the Found New Hardware Wizard” window opens (see *Figure 27*). Select “Yes, this time only”, and click on “Next >”.

Figure 27. Welcome to the Found New Hardware Wizard window



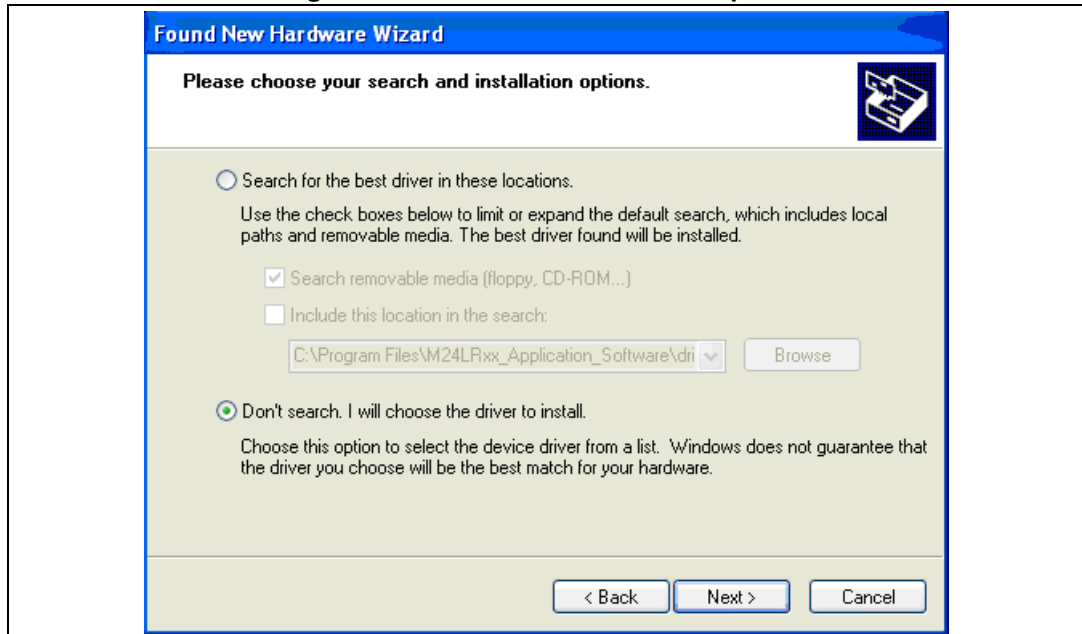
- In the next window (see [Figure 28](#)), select “Install from a list or specific location (Advanced)”, and click on “Next >”.

**Figure 28. “Install from a list or specific location (Advanced)”**



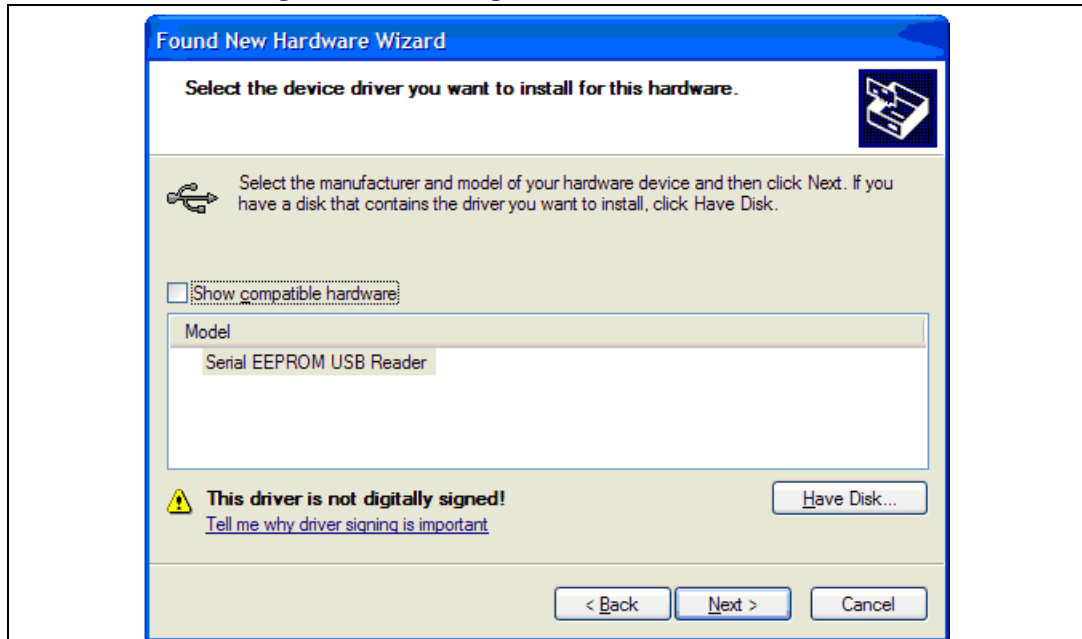
- As shown in [Figure 29](#), select “Don’t search. I will choose the driver to install.”, and click on “Next >”.

**Figure 29. Search and installation options**



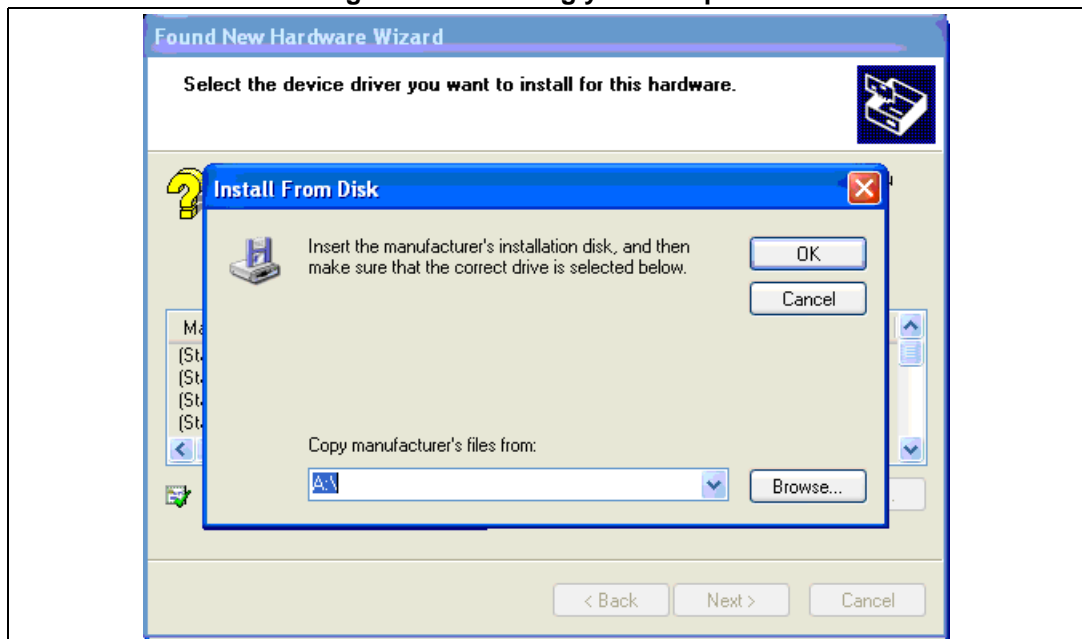
13. In the next window (see [Figure 30](#)), uncheck the box in front of “Show compatible hardware” and click on “Have Disk...”.

**Figure 30. Selecting the device driver to install**



14. Then, click on “Browse...” to locate the file (see [Figure 15](#) and [Figure 16](#)).

**Figure 31. Browsing your computer**



15. Browse your computer for the *Serial\_EEPROM\_USB\_Reader\_driver.inf* file. The default path is:



C:/Program File/M24LRxx\_Application\_Software/driver/Serial EEPROM USB Reader Driver/

Select the *Serial EEPROM USB Reader\_driver.inf* file and then click on “Open” (see [Figure 32](#)) and “OK” (see [Figure 33](#))

Figure 32. File location

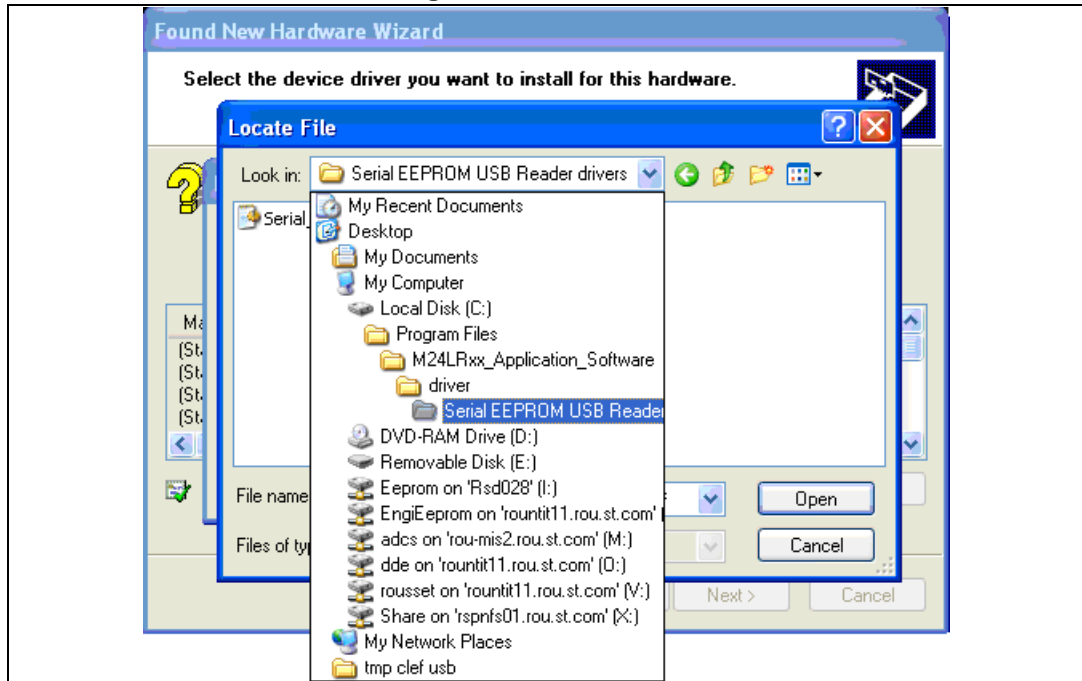
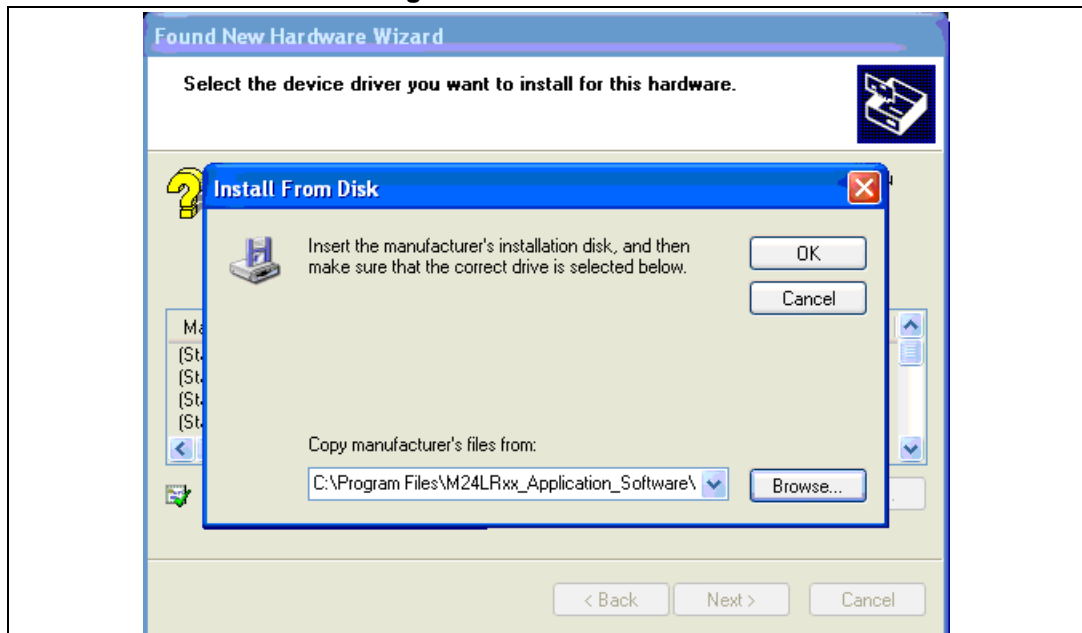
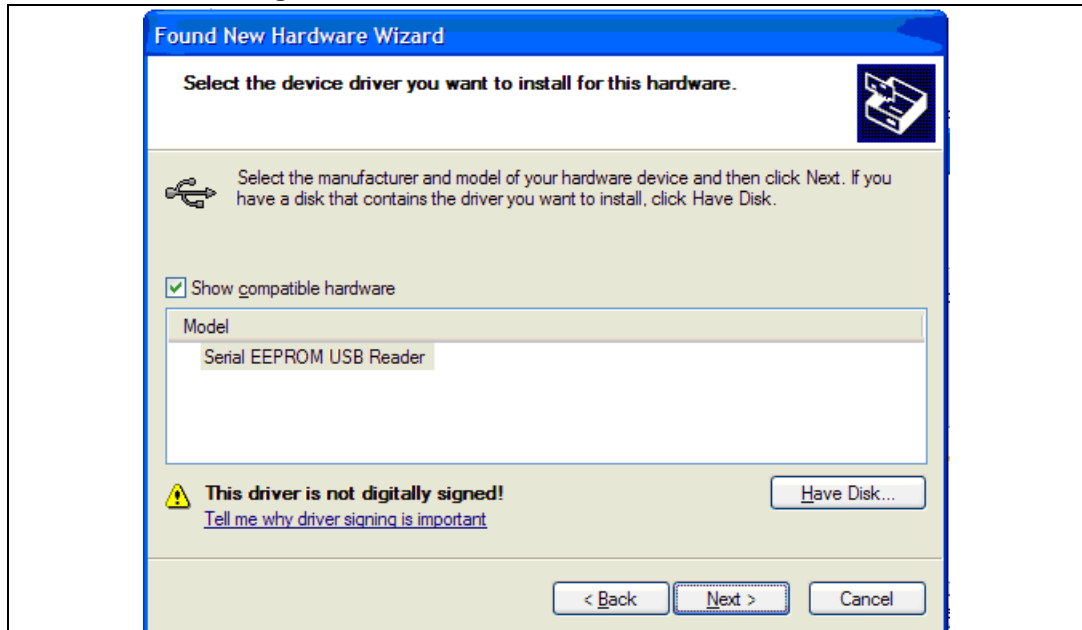


Figure 33. Instal from disk



- 16. The window now displays the EEPROM USB drivers that have been selected (see [Figure 34](#)). Click on “Next >” to install the driver (see [Figure 35](#)).

**Figure 34. EEPROM USB drivers to be installed**



- 17. During the installation, a new windows appears to inform you that the driver was not certified by Microsoft®. Click on “Continue Anyway”. When the installation is complete, click on “Finish” (see [Figure 36](#)).

Figure 35. Software installation

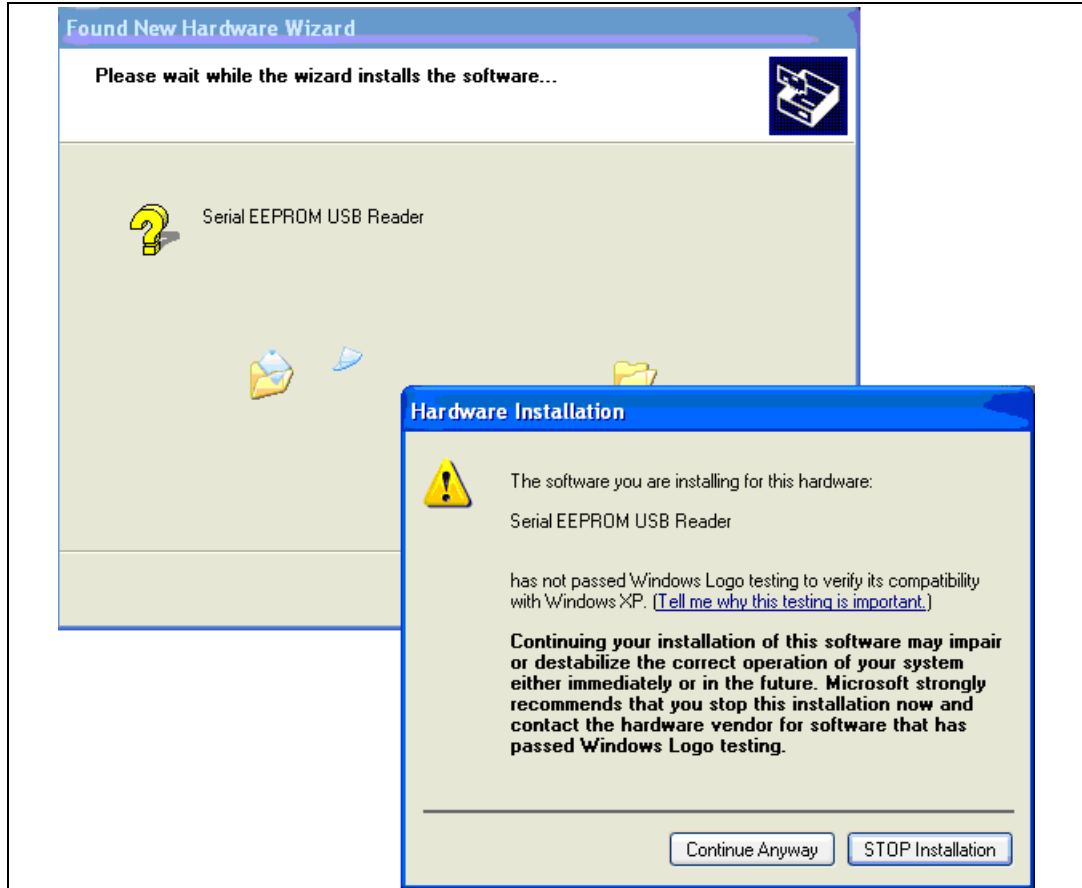
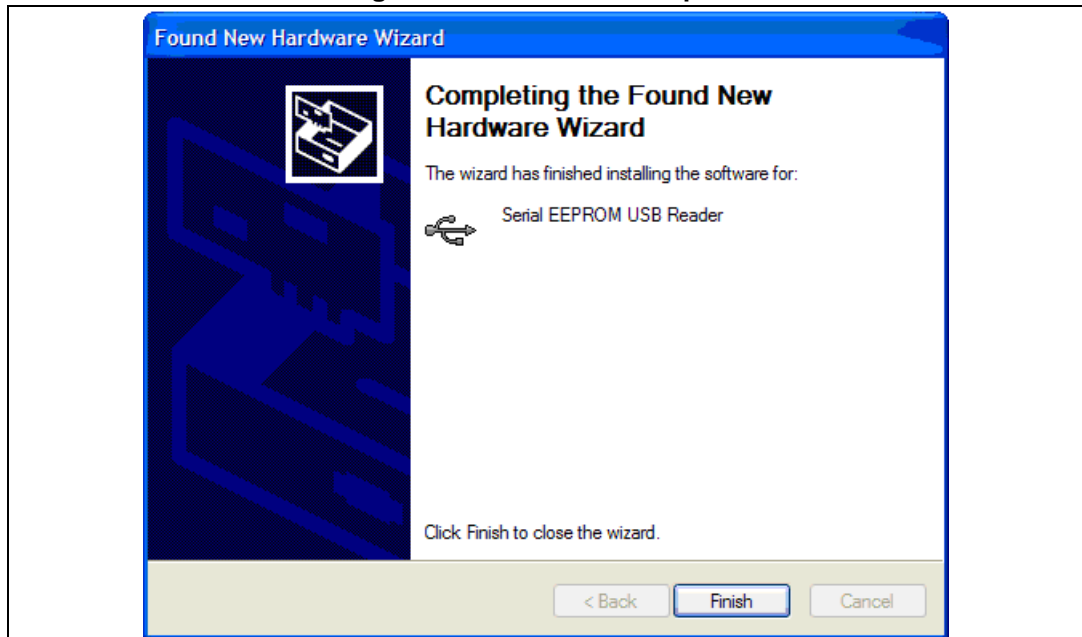


Figure 36. Installation complete

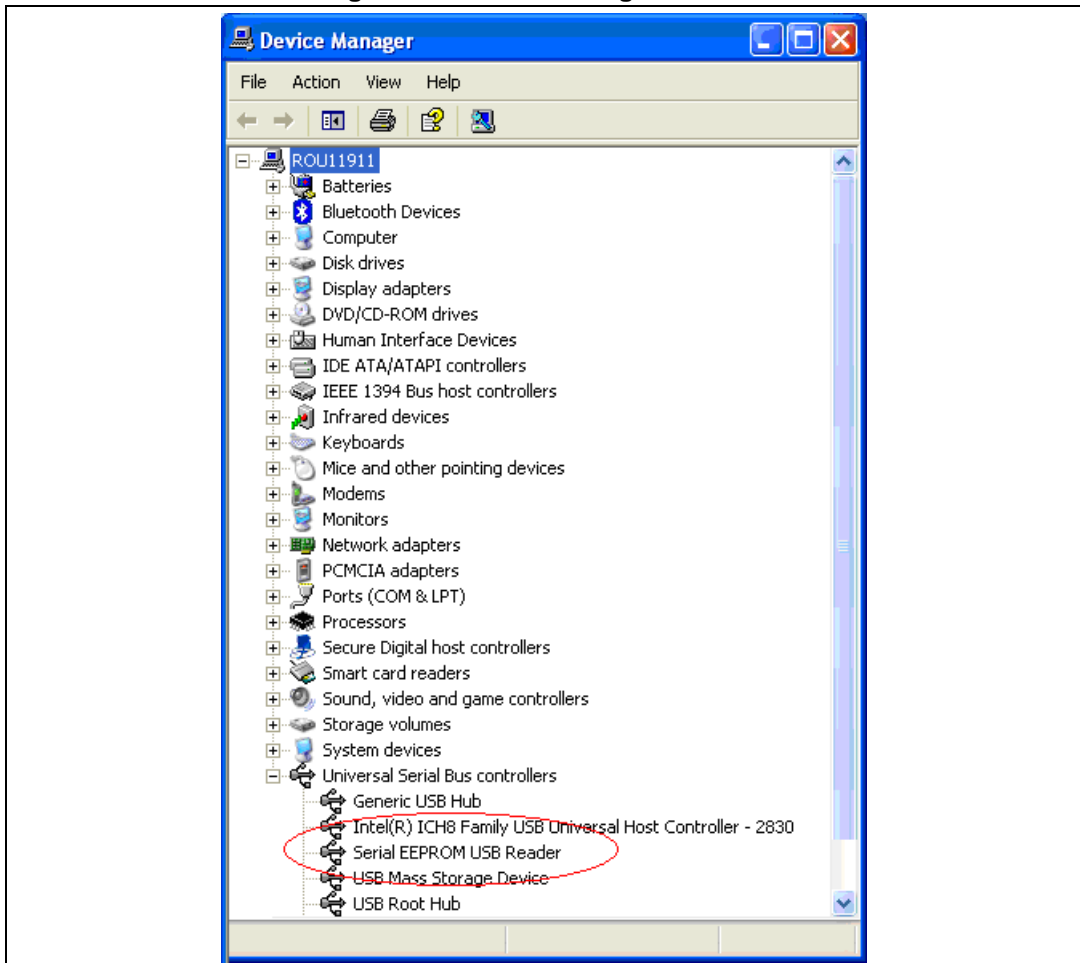


The drivers allowing your computer to interface the I<sup>2</sup>C bus reader are now installed.

**Advanced information**

You can check that the I<sup>2</sup>C bus reader drivers are installed by going to Start/Settings/Control Panel/System. Click on the Hardware tab and then on Device Manager. In the Device Manager the I<sup>2</sup>C bus reader should be shown as a USB peripheral (defined as *Serial EEPROM USB Reader*, as shown in [Figure 36](#)).

Figure 37. Device Manager window



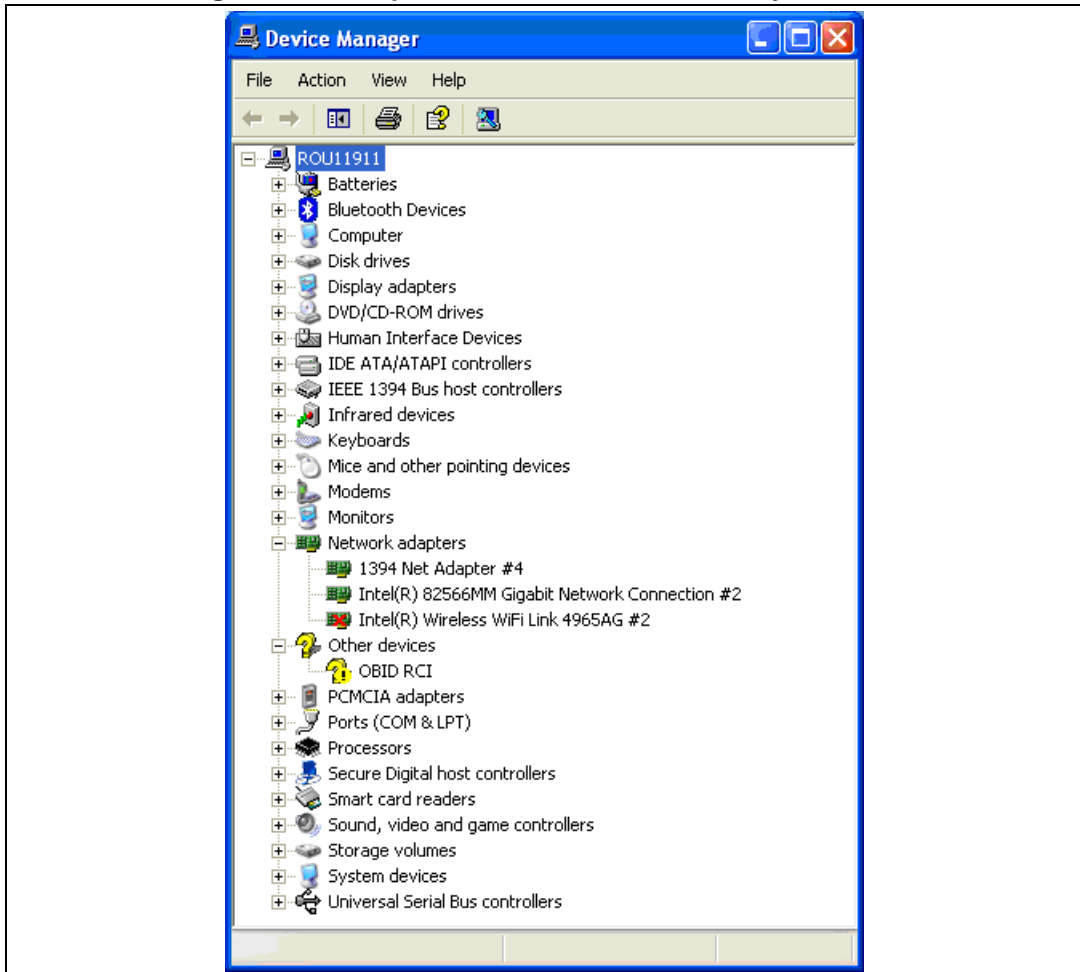
## 2.3 Trouble shooting

### 2.3.1 RF reader driver

You can check that the drivers for the RF and I<sup>2</sup>C bus readers are correctly installed by viewing the “Device Manager” window.

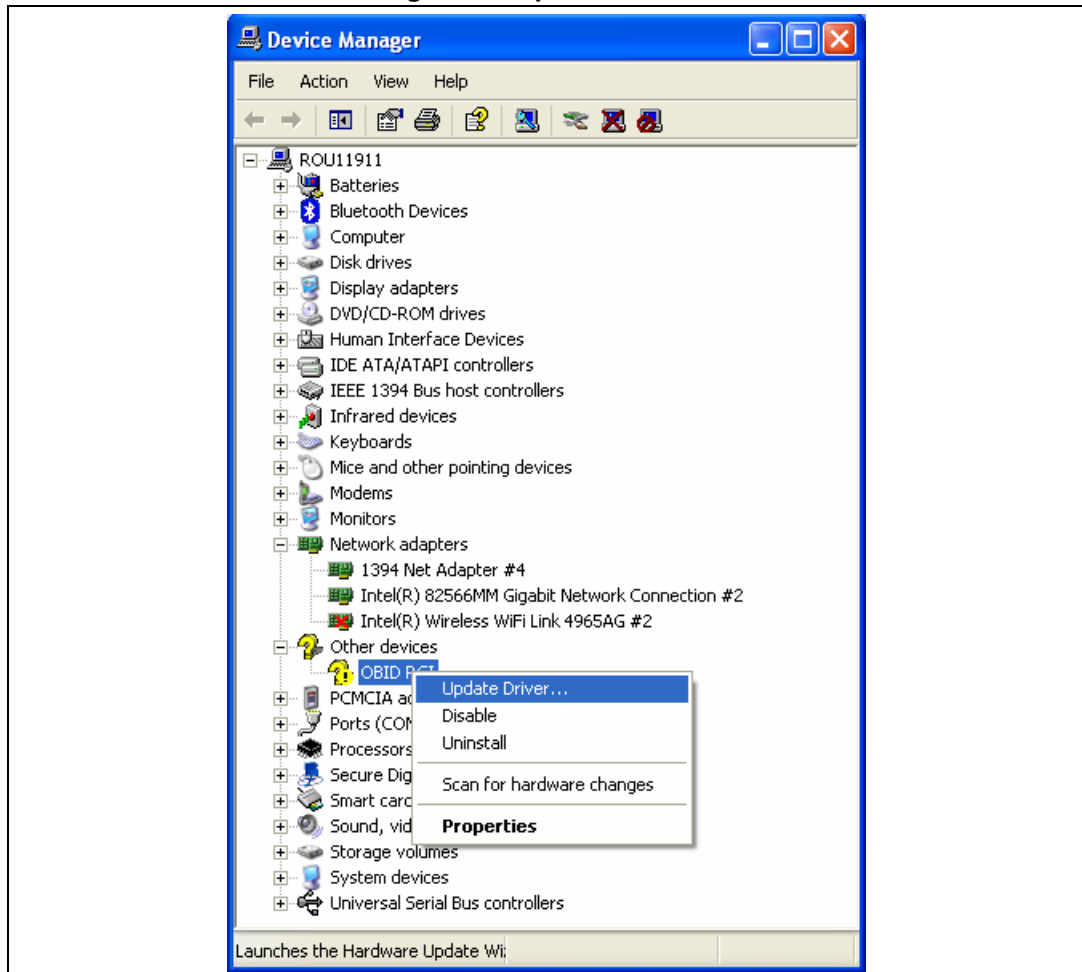
In the example shown in *Figure 38*, you can see that the OBID is not correctly installed.

**Figure 38. Example where OBID is not correctly installed**



Right-click on “OBID RCI” and select “Update Driver...” as shown in *Figure 39*.

Figure 39. Update Driver...



You can now try to reinstall the reader drivers, as explained in [Section 2.1: Step1: Installing the drivers for the medium-range RF reader](#) for the RF reader, and in [Section 2.2: Step2: Installing the drivers for the I<sup>2</sup>C serial bus reader \(serial EEPROM USB reader\)](#) for the I<sup>2</sup>C reader).

## 3 Tool kit descriptions

### 3.1 M24LRXX development kit

#### 3.1.1 Ordering information

The part number of the development kit is: **DEVKIT-M24LR-A**.

#### 3.1.2 Development kit package

The development kit contains:

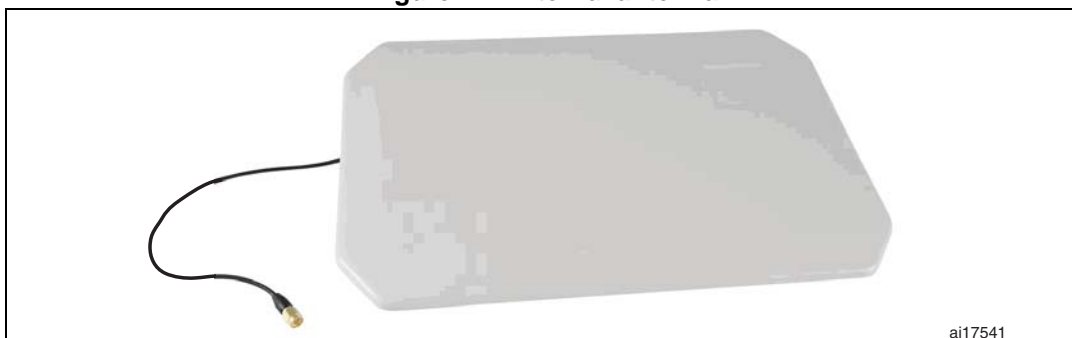
- a middle-range RF reader (ISO 15693, RF 13.56 MHz) interfaced via the USB bus and an external power supply to have a greater read range.

**Figure 40. RF reader**



- an external antenna shown in [Figure 41](#).

**Figure 41. External antenna**



- Serial EEPROM USB reader: I<sup>2</sup>C bus reader (interfaced via the USB bus). [Figure 42](#) shows the reader.

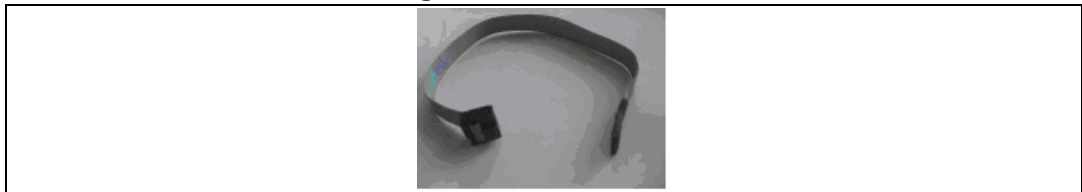


Figure 42. I<sup>2</sup>C bus reader (serial EEPROM USB reader)



- An I<sup>2</sup>C bus cable to connect the serial EEPROM USB reader and the I<sup>2</sup>C bus of the reference antenna. [Figure 43](#) shows the cable to use.

Figure 43. I<sup>2</sup>C bus cable



- M24LR64-R's reference antennas:
  - ANT1-M24LR-A: RF antenna size: 75 mm x 45 mm (2.9 in x 1.77 in) shown in [Figure 44](#).
  - ANT2-M24LR-A: RF antenna size: 20 mm x 40 mm (0.79 in x 1.57 in) shown in [Figure 45](#).

Figure 44. ANT1-M24LR-A reference antenna

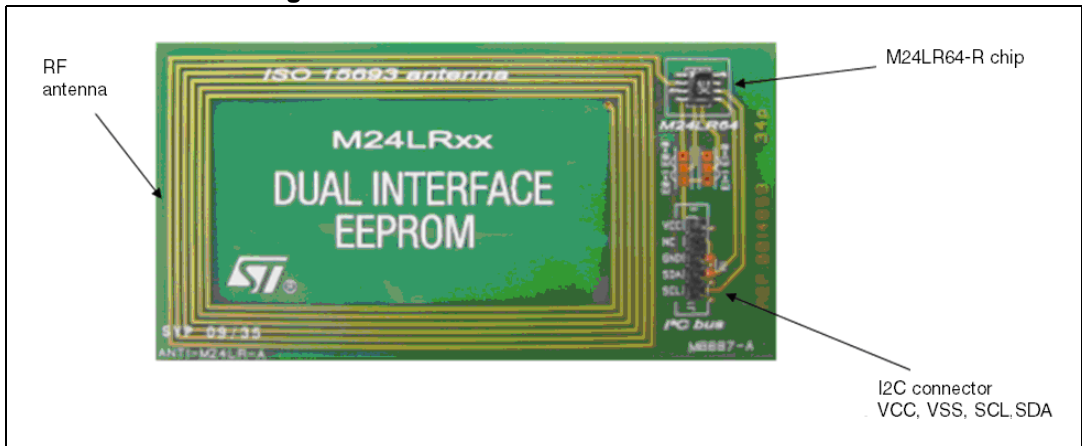
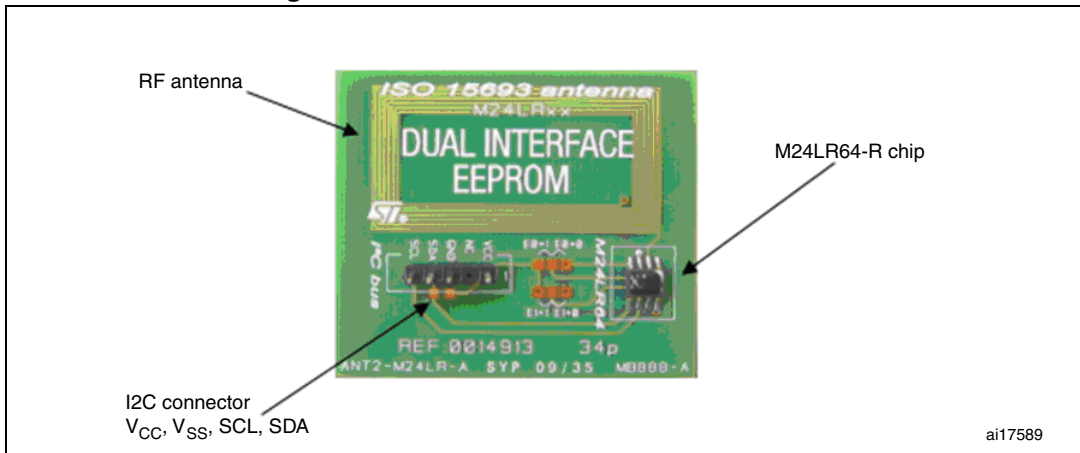
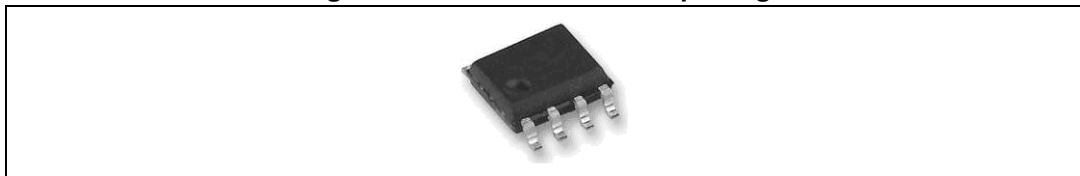


Figure 45. ANT2-M24LR-A reference antenna



- M24LR64-R samples in SO8 package (see [Figure 46](#)).

Figure 46. M24LR64-R in SO8 package



## 3.2 M24LR64-R demonstration kit

### 3.2.1 Ordering information

The part number of the demonstration kit is: **DEMOKIT-M24LR-A**.

### 3.2.2 Demonstration kit package

The demonstration kit contains:

- a middle-range RF reader (ISO 15693, RF 13.56 MHz) interfaced via the USB bus, shown in [Figure 47](#).
- an M24LR64-R's reference antenna: PRIM2-M24LR-A, RF antenna size: 20 mm x 40 mm (0.79 in x 1.57 in) shown in [Figure 48](#).
- Optional: STM32-PRIMER2 (to be ordered separately) shown in [Figure 49](#).

Figure 47. RF reader



Figure 48. PRIM2-M24LR-A reference antenna

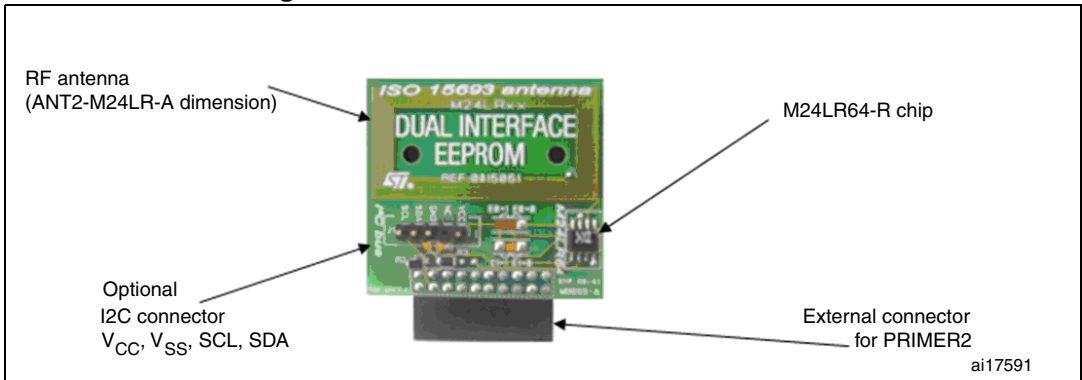


Figure 49. STM32-PRIMER2



- 1. Not included in the kit, to be ordered separately.

**Figure 50. Connecting your reference antenna to your STM32-PRIMER2**

### 3.3 M24LR64-R starter kit

#### 3.3.1 Ordering information

The part number of the starter kit is: STARTKIT-M24LR-A.

The STARTKIT-M24LR-A is replaced by the M24LR-DISCOVERY. STMicroelectronics thus recommends not to use the STARTKIT-M24LR-A for new applications.

#### 3.3.2 Starter kit package

The starter kit contains:

- a reader with an integrated solution for I<sup>2</sup>C communication (connector) and RF communication (ISO 15693, RF 13.56 MHz) interfaced with a USB bus as shown in [Figure 51](#).

Figure 51. I<sup>2</sup>C & RF reader



- M24LR64-R's reference antennas:
  - ANT1-M24LR-A: RF antenna size: 75 mm x 45 mm (2.9 in x 1.77 in) shown in [Figure 44](#).
  - ANT2-M24LR-A: RF antenna size: 20 mm x 40 mm (0.79 in x 1.57 in) shown in [Figure 45](#).

Figure 52. ANT1-M24LR-A reference antenna

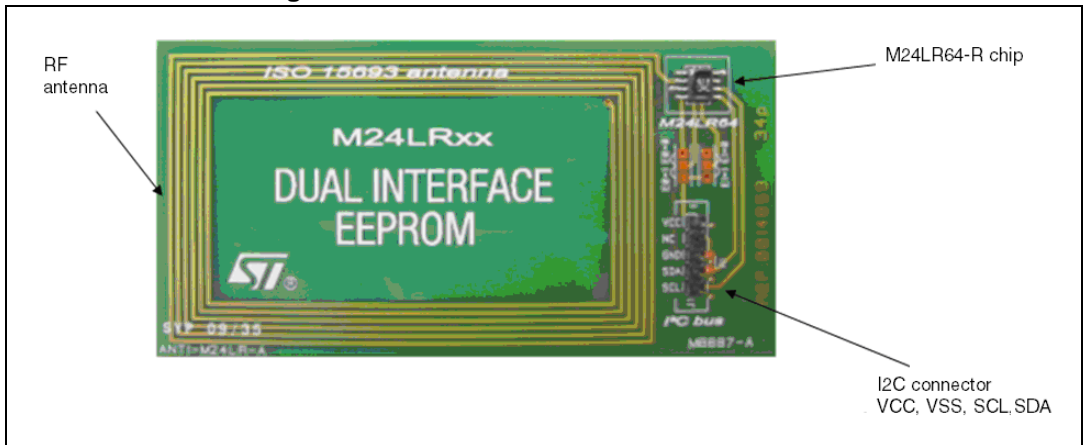
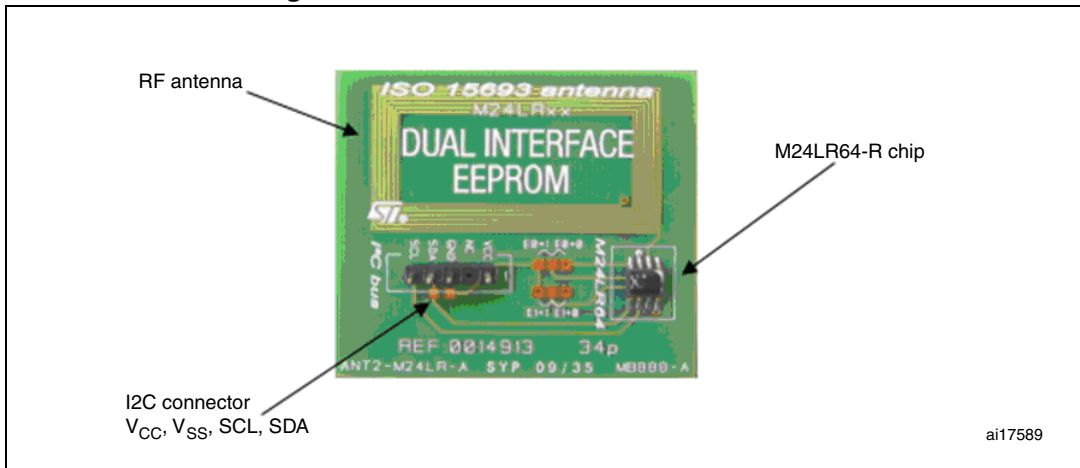
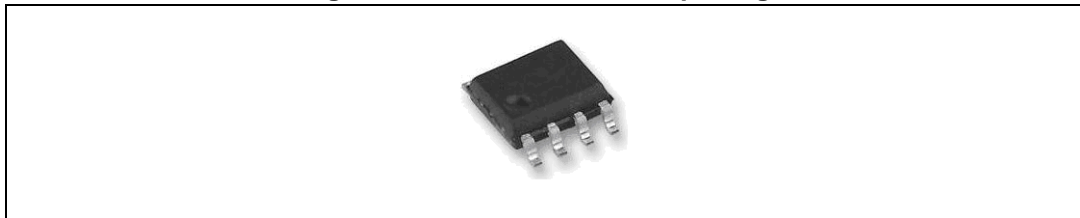


Figure 53. ANT2-M24LR-A reference antenna



- M24LR64-R samples in SO8 package (see [Figure 46](#)).

Figure 54. M24LR64-R in SO8 package



### 3.4 DEMO-CR95HF-A

#### 3.4.1 Ordering information

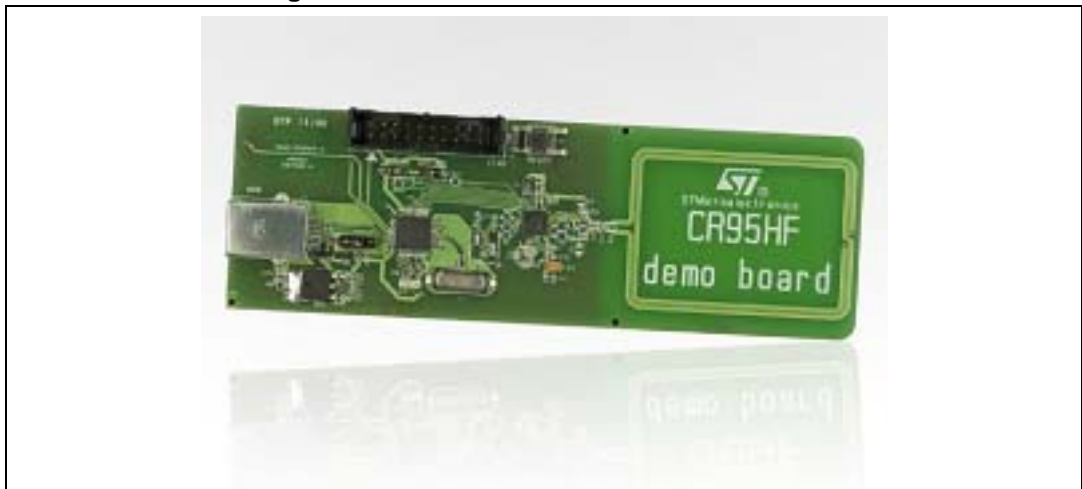
The part number of the CR95HF demo kit is DEMO-CR95HF-A.

#### 3.4.2 DEMO-CR95HF-A

The DEMO-CR95HF-A is a demonstration kit used to evaluate the performances of ST CR95HF 13.56 MHz multiprotocol contactless transceiver.

The DEMO-CR95HF-A is powered through the USB bus and no external power supply is required. It includes a CR95HF contactless transceiver, a 47 x 34 mm 13.56 MHz inductive etched antenna and its associated tuning components.

Figure 55. DEMO-CR95HF-A demonstration kit



### 3.5 Connecting the readers and cables to your computer

Once the installation of the software drivers is complete (see previous sections [Installing the setup.exe](#) and [Installing the setup.exe](#)), you have to physically connect the readers.

#### Connecting the RF reader

- first, connect the external antenna to the RF reader
  - then, connect the power supply of the RF reader
  - you can now connect the RF reader to the USB port of your computer
- The RF reader is ready to be used. Keep your tag on the external antenna to communicate through the application software.

#### Connecting the I<sup>2</sup>C bus reader

- First, connect the I<sup>2</sup>C bus reader to the USB port of your computer
- then connect the I<sup>2</sup>C cable from the I<sup>2</sup>C bus reader to an M24LR64-R tag

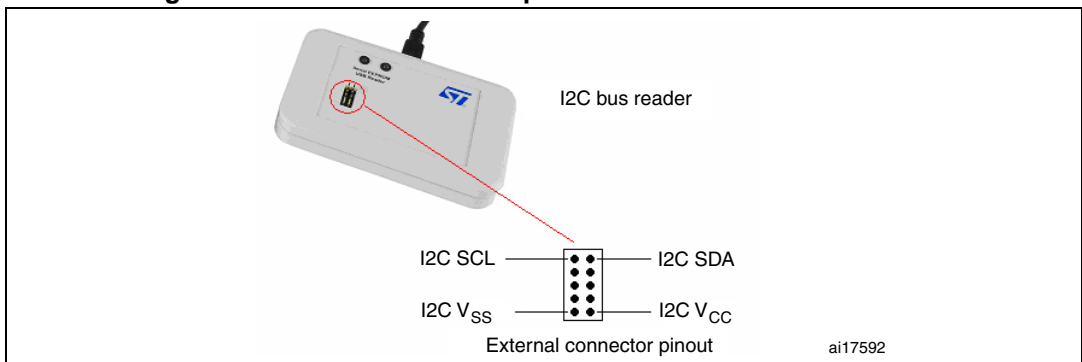
Figure 56. External connector pinout of the serial I<sup>2</sup>C bus reader

Figure 57. External connector pinout of the M24LR64-R tag

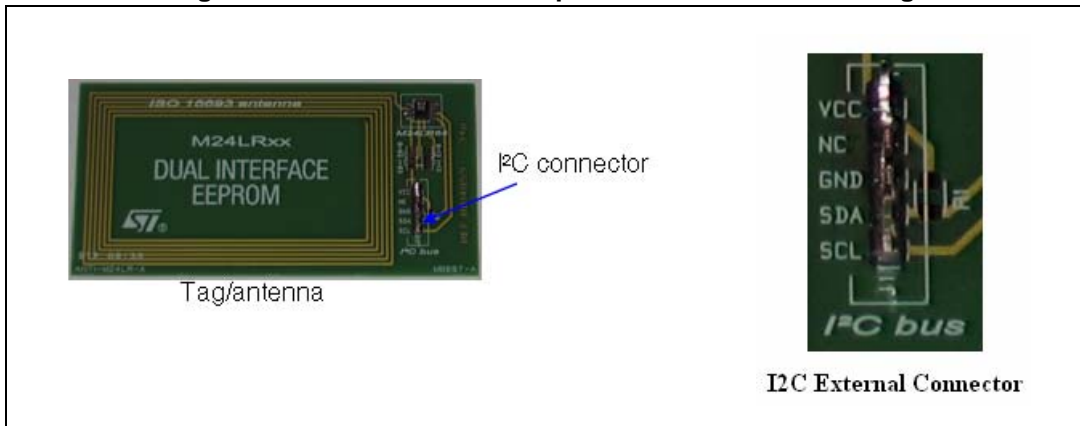
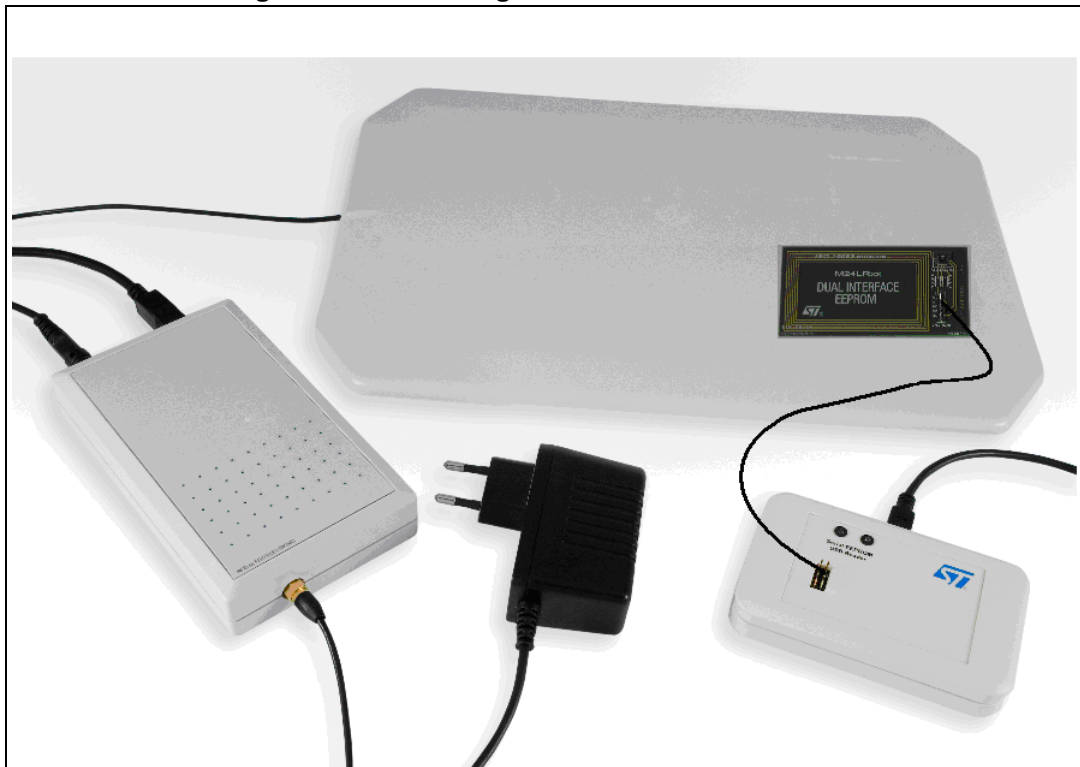


Figure 58. Connecting the RF and I<sup>2</sup>C bus readers



### 3.6 Web support and references

ST products (M24LR64-R datasheet, application notes, etc.)  
Serial EEPROM USB reader  
Software

*For further information and copies of the available technical documentation, please contact your nearest ST sales office.*



FEIG ELECTRONICS RF readers

<http://www.obid.eu/>

<http://www.feig.de/>

eStar RF & I<sup>2</sup>C reader

<http://www.estarcorp.net/en/index.asp>

STM32-PRIMER2

<http://www.raisonance.com/>

<http://www.stm32circle.com/>

**You can now enjoy your kit!**

## 4 Revision history

Table 1. Document revision history

Date	Revision	Changes
30-Nov-2009	1	Initial release.
22-Sep-2011	2	Modified title of document. Replaced part number "M24LR64-R" with "M24LRXX" throughout the document. Added <a href="#">Section 3.4: DEMO-CR95HF-A</a> .
28-Oct-2011	3	Changed document title.
13-May-2013	4	Updated document title. Updated <a href="#">Section : Introduction</a> and <a href="#">Section 1: Installing the setup.exe</a> to present the STSW-M24LR011. Updated <a href="#">Section 3.3: M24LR64-R starter kit</a> . Document converted to new corporate template and disclaimer updated.

**Please Read Carefully:**

Information in this document is provided solely in connection with ST products. STMicroelectronics NV and its subsidiaries ("ST") reserve the right to make changes, corrections, modifications or improvements, to this document, and the products and services described herein at any time, without notice.

All ST products are sold pursuant to ST's terms and conditions of sale.

Purchasers are solely responsible for the choice, selection and use of the ST products and services described herein, and ST assumes no liability whatsoever relating to the choice, selection or use of the ST products and services described herein.

No license, express or implied, by estoppel or otherwise, to any intellectual property rights is granted under this document. If any part of this document refers to any third party products or services it shall not be deemed a license grant by ST for the use of such third party products or services, or any intellectual property contained therein or considered as a warranty covering the use in any manner whatsoever of such third party products or services or any intellectual property contained therein.

**UNLESS OTHERWISE SET FORTH IN ST'S TERMS AND CONDITIONS OF SALE ST DISCLAIMS ANY EXPRESS OR IMPLIED WARRANTY WITH RESPECT TO THE USE AND/OR SALE OF ST PRODUCTS INCLUDING WITHOUT LIMITATION IMPLIED WARRANTIES OF MERCHANTABILITY, FITNESS FOR A PARTICULAR PURPOSE (AND THEIR EQUIVALENTS UNDER THE LAWS OF ANY JURISDICTION), OR INFRINGEMENT OF ANY PATENT, COPYRIGHT OR OTHER INTELLECTUAL PROPERTY RIGHT.**

**ST PRODUCTS ARE NOT AUTHORIZED FOR USE IN WEAPONS. NOR ARE ST PRODUCTS DESIGNED OR AUTHORIZED FOR USE IN: (A) SAFETY CRITICAL APPLICATIONS SUCH AS LIFE SUPPORTING, ACTIVE IMPLANTED DEVICES OR SYSTEMS WITH PRODUCT FUNCTIONAL SAFETY REQUIREMENTS; (B) AERONAUTIC APPLICATIONS; (C) AUTOMOTIVE APPLICATIONS OR ENVIRONMENTS, AND/OR (D) AEROSPACE APPLICATIONS OR ENVIRONMENTS. WHERE ST PRODUCTS ARE NOT DESIGNED FOR SUCH USE, THE PURCHASER SHALL USE PRODUCTS AT PURCHASER'S SOLE RISK, EVEN IF ST HAS BEEN INFORMED IN WRITING OF SUCH USAGE, UNLESS A PRODUCT IS EXPRESSLY DESIGNATED BY ST AS BEING INTENDED FOR "AUTOMOTIVE, AUTOMOTIVE SAFETY OR MEDICAL" INDUSTRY DOMAINS ACCORDING TO ST PRODUCT DESIGN SPECIFICATIONS. PRODUCTS FORMALLY ESCC, QML OR JAN QUALIFIED ARE DEEMED SUITABLE FOR USE IN AEROSPACE BY THE CORRESPONDING GOVERNMENTAL AGENCY.**

Resale of ST products with provisions different from the statements and/or technical features set forth in this document shall immediately void any warranty granted by ST for the ST product or service described herein and shall not create or extend in any manner whatsoever, any liability of ST.

ST and the ST logo are trademarks or registered trademarks of ST in various countries.

Information in this document supersedes and replaces all information previously supplied.

The ST logo is a registered trademark of STMicroelectronics. All other names are the property of their respective owners.

© 2013 STMicroelectronics - All rights reserved

STMicroelectronics group of companies

Australia - Belgium - Brazil - Canada - China - Czech Republic - Finland - France - Germany - Hong Kong - India - Israel - Italy - Japan - Malaysia - Malta - Morocco - Philippines - Singapore - Spain - Sweden - Switzerland - United Kingdom - United States of America

[www.st.com](http://www.st.com)

