

LM3535 Multi-Display LED Driver With Ambient Light Sensing and Dynamic Backlight Control Compatibility

1 Features

- Drives Up to 8 LEDs Each With Up to 25 mA of Diode Current
- External PWM Input for Dynamic Backlight Control
- Multi-Zone Ambient Light Sensing (ALS)
- ALS Interrupt Reporting
- Independent On/Off Control for All Current Sinks
- 128 Exponential Dimming Steps With 600:1 Dimming Ratio for Group A (Up to 6 LEDs)
- 8 Linear Dimming States for Groups B (Up to 3 LEDs) and D1C (1 LED)
- Programmable Auto-Dimming Function
- Up to 90% Efficiency
- 0.55% Accurate Current Matching
- Wide Input Voltage Range (2.7 V to 5.5 V)
- Active High Hardware Enable
- Total Solution Size < 16 mm²
- Low Profile 20-Pin DSBGA Package

2 Applications

- Smart-Phone LED Backlighting
- Large Format LCD Backlighting
- General LED Lighting

3 Description

The LM3535 device is a highly integrated LED driver capable of driving 8 LEDs in parallel for large display applications. Independent LED control allows selection of a subset of the 6 main display LEDs for partial-illumination applications. In addition to the main bank of 6, the LM3535 is capable of driving an additional 2 independently controlled LEDs to support Indicator applications.

The LED driver current sinks are split into three independently controlled groups. The primary group can be configured to drive up to six LEDs for use in the main phone display. Groups B and C are provided for driving secondary displays, keypads and indicator LEDs. All of the LED current sources can be independently turned on and off providing flexibility to address different application requirements.

The LM3535 provides multi-zone ambient light sensing allowing autonomous backlight intensity control in the event of changing ambient light conditions. A PWM input is also provided to give the user the means to adjust the backlight intensity dynamically based upon the content of the display.

The LM3535 provides excellent efficiency without the use of an inductor by operating the charge pump in a gain of 3/2 or in pass mode. The proper gain for maintaining current regulation is chosen, based on LED forward voltage, so that efficiency is maximized over the input voltage range.

The LM3535 is available in a tiny 20-pin, 0.4-mm pitch, thin DSBGA package.

Device Information⁽¹⁾

PART NUMBER	PACKAGE	BODY SIZE (MAX)
LM3535	DSBGA (20)	2.045 mm x 1.64 mm

(1) For all available packages, see the orderable addendum at the end of the data sheet.

Typical Application

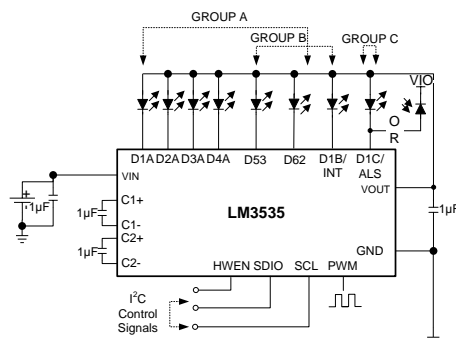

Table of Contents

1 Features 1 2 Applications 1 3 Description 1 4 Revision History 2 5 Pin Configuration and Functions 3 6 Specifications 4 6.1 Absolute Maximum Ratings 4 6.2 ESD Ratings 4 6.3 Recommended Operating Conditions 4 6.4 Thermal Information 5 6.5 Electrical Characteristics 5 6.6 Typical Characteristics 7 7 Detailed Description 10 7.1 Overview 10 7.2 Functional Block Diagram 10 7.3 Feature Description 11	7.4 Device Functional Modes 12 7.5 Programming 12 8 Application and Implementation 19 8.1 Application Information 19 8.2 Typical Application 19 9 Power Supply Recommendations 28 10 Layout 29 10.1 Layout Guidelines 29 10.2 Layout Example 29 11 Device and Documentation Support 30 11.1 Receiving Notification of Documentation Updates 30 11.2 Community Resources 30 11.3 Trademarks 30 11.4 Electrostatic Discharge Caution 30 11.5 Glossary 30 12 Mechanical, Packaging, and Orderable Information 30
---	---

4 Revision History

NOTE: Page numbers for previous revisions may differ from page numbers in the current version.

Changes from Revision A (May 2013) to Revision B	Page
• Added <i>Pin Configuration and Functions</i> section, <i>ESD Ratings</i> table, <i>Feature Description</i> , <i>Device Functional Modes</i> , <i>Application and Implementation</i> , <i>Power Supply Recommendations</i> , <i>Layout</i> , <i>Device and Documentation Support</i> , and <i>Mechanical, Packaging, and Orderable Information</i>	1
• Deleted references to "ALS2" option	1
• Changed ALS resistor accuracy values from –5% and 5% to –9% and 9%	6

Changes from Original (May 2013) to Revision A	Page
• Changed layout of National Data Sheet to TI format	27

5 Pin Configuration and Functions

**YFQ Package
20-Pin DSBGA
Top View**

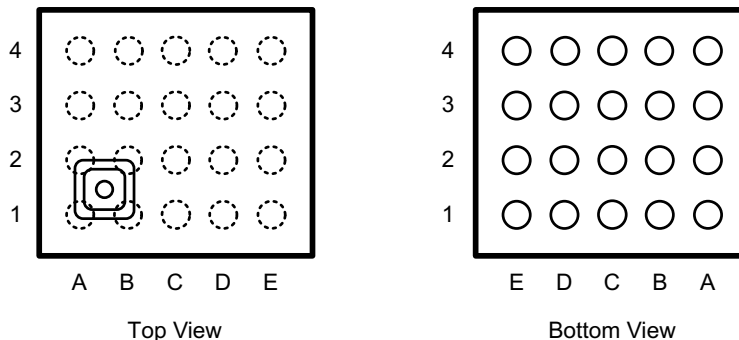

Pin Functions

PIN		TYPE	DESCRIPTION
NO.	NAME		
A1, C1, B1, B2	C1+, C1-, C2+, C2-	Power	Flying capacitor connections
A2	V _{OUT}	Power	Charge pump output voltage
A3	V _{IN}	Power	Input voltage; input range: 2.7 V to 5.5 V
A4	GND	Power	Ground
B3	D1B / INT	Input / Output	LED driver/ ALS interrupt - GroupB current sink or ALS interrupt pin. In ALS Interrupt mode, a pullup resistor is required. A zero (0) means a change has occurred, while a one (1) means no ALS adjustment has been made.
B4, C4	D53, D62	Output	LED drivers - configurable current sinks. Can be assigned to GroupA or GroupB
C2	SDIO	Input / Output	Serial data input/output pin
C3	D1C / ALS	Input / Output	LED driver / ALS input - indicator LED current sink or ambient light sensor input
D1	GND	Power	Ground
D2	PWM	Input	External PWM input - allows the current sinks to be turned on and off at a frequency and duty cycle externally controlled. Minimum on-time pulse width = 15 μsec.
D3, E3, E4, D4	D1A-D4A	Output	LED drivers - GroupA
E1	HWEN	Input	Hardware enable pin. High = normal operation, Low = RESET
E2	SCL	Input	Serial clock pin

6 Specifications

6.1 Absolute Maximum Ratings

 over operating free-air temperature range (unless otherwise noted)⁽¹⁾⁽²⁾⁽³⁾

	MIN	MAX	UNIT
V _{IN} pin voltage	-0.3	6	V
SCL, SDIO, HWEN, PWM pin voltages	-0.3	(V _{IN} + 0.3 V) with 6 V maximum	V
I _{Dxx} pin voltages	-0.3	(V _{VOUT} + 0.3 V) with 6 V maximum	V
Continuous power dissipation ⁽⁴⁾	Internally limited		
Junction temperature, t _{J-MAX}		150	°C
Maximum lead temperature (soldering)		See ⁽⁵⁾	°C
Storage temperature, T _{stg}	-65	150	°C

- (1) Stresses beyond those listed under *Absolute Maximum Ratings* may cause permanent damage to the device. These are stress ratings only, which do not imply functional operation of the device at these or any other conditions beyond those indicated under *Recommended Operating Conditions*. Exposure to absolute-maximum-rated conditions for extended periods may affect device reliability.
- (2) All voltages are with respect to the potential at the GND pins.
- (3) If Military/Aerospace specified devices are required, contact the Texas Instruments Sales Office/ Distributors for availability and specifications. All voltages are with respect to the potential at the GND pins.
- (4) Internal thermal shutdown circuitry protects the device from permanent damage. Thermal shutdown engages at T_J = 150°C (typical) and disengages at T_J = 125°C (typical).
- (5) For detailed soldering specifications and information, see Texas Instruments Application Report [AN-1112 DSBGA Wafer Level Chip Scale Package](#).

6.2 ESD Ratings

	VALUE	UNIT
V _(ESD) Electrostatic discharge Human-body model (HBM), per ANSI/ESDA/JEDEC JS-001 ⁽¹⁾⁽²⁾	±2000	V

- (1) JEDEC document JEP155 states that 500-V HBM allows safe manufacturing with a standard ESD control process.
- (2) The human body model is a 100-pF capacitor discharged through a 1.5-kΩ resistor into each pin. (MIL-STD-883 3015.7).

6.3 Recommended Operating Conditions

 over operating free-air temperature range (unless otherwise noted)⁽¹⁾⁽²⁾

	MIN	MAX	UNIT
Input voltage	2.7	5.5	V
LED voltage	2	4	V
Junction temperature, T _J	-30	110	°C
Ambient temperature, T _A ⁽³⁾	-30	85	°C

- (1) *Absolute Maximum Ratings* indicate limits beyond which damage to the component may occur. *Recommended Operating Ratings* are conditions under which operation of the device is ensured. Recommended Operating Ratings do not imply ensured performance limits. For ensured performance limits and associated test conditions, see the *Electrical Characteristics* tables.
- (2) All voltages are with respect to the potential at the GND pins.
- (3) In applications where high power dissipation and/or poor package thermal resistance is present, the maximum ambient temperature may have to be derated. Maximum ambient temperature (T_{A-MAX}) is dependent on the maximum operating junction temperature (T_{J-MAX-OP} = 110°C), the maximum power dissipation of the device in the application (P_{D-MAX}), and the junction-to ambient thermal resistance of the device/package in the application (R_{θJA}), as given by the following equation: T_{A-MAX} = T_{J-MAX-OP} - (R_{θJA} × P_{D-MAX}).

6.4 Thermal Information

THERMAL METRIC ⁽¹⁾		LM3535	UNIT
		YFQ (WCSP)	
		20 PINS	
R _{θJA}	Junction-to-ambient thermal resistance	70.5	°C/W
R _{θJC(top)}	Junction-to-case (top) thermal resistance	0.6	°C/W
R _{θJB}	Junction-to-board thermal resistance	16.7	°C/W
ψ _{JT}	Junction-to-top characterization parameter	0.4	°C/W
ψ _{JB}	Junction-to-board characterization parameter	16.9	°C/W
R _{θJC(bot)}	Junction-to-case (bottom) thermal resistance	N/A	°C/W

(1) For more information about traditional and new thermal metrics, see the [Semiconductor and IC Package Thermal Metrics](#) application report.

6.5 Electrical Characteristics

Typical limits are T_A = 25°C, and minimum and maximum limits in apply over the full operating temperature range (–30°C to +85°C). Unless otherwise specified: V_{IN} = 3.6 V; V_{HWEN} = V_{IN}; V_{PWM} = 0 V; V_{DxA} = V_{DxB} = V_{DxC} = 0.4 V; GroupA = GroupB = GroupC = full-scale current; ENxA, ENxB, ENxC bits = 1; 53A, 62A bits = 0; C₁ = C₂ = C_{IN} = C_{OUT} = 1 μF.⁽¹⁾⁽²⁾⁽³⁾

PARAMETER		TEST CONDITIONS	MIN	TYP	MAX	UNIT
I _{Dxx}	Output current regulation GroupA	2.7 V ≤ V _{IN} ≤ 5.5 V EN1A to EN4A = 1, 53A = 62A = 0, EN53 = EN62 = ENxB = ENxC = 0 4 LEDs in GroupA	23.6 (–5.6%)	25	26.3 (5.2%)	mA (%)
		2.7 V ≤ V _{IN} ≤ 5.5 V EN1A to EN4A = EN53 = EN62 = 1, 53A = 62A = 1, ENxB = ENxC = 0 6 LEDs in GroupA	23.2 (–7.2%)	25	26.3 5.2%	mA (%)
	Output current regulation GroupB	2.7 V ≤ V _{IN} ≤ 5.5 V EN1B = EN53 = EN62 = 1, 53A = 62A = 0, ENxA = ENC = 0 3 LEDs in GroupB	23.3 (–6.8%)	25	(+4%)	mA (%)
	Output current regulation IDC	2.7 V ≤ V _{IN} ≤ 5.5 V ENC = 1, ENxA = ENxB = 0	23.8 (–4.8%)	25	26.8 (7.2%)	mA (%)
	Output current regulation GroupA, GroupB, and GroupC enabled	3.2 V ≤ V _{IN} ≤ 5.5 V V _{LED} = 3.6 V		25 DxA		mA
			25 DxB			
			25 DxC			
I _{Dxx-MATCH}	LED current matching ⁽⁴⁾	2.7 V ≤ V _{IN} ≤ 5.5 V	GroupA (4 LEDs)		0.25%	2.4%
			GroupA (6 LEDs)		0.55%	2.78
			GroupB (3 LEDs)		0.25%	2.41%
V _{DxTH}	V _{Dxx} 1x to 3/2x gain transition threshold	V _{DxA} and/or V _{DxB} falling		130		mV
V _{HR}	Current sink headroom voltage requirement ⁽⁵⁾	I _{Dxx} = 95% × I _{Dxx} (nominal) (I _{Dxx} (nominal) = 25 mA)		100		mV

(1) All voltages are with respect to the potential at the GND pins.

(2) Minimum and maximum limits are ensured by design, test, or statistical analysis. Typical numbers are not ensured, but do represent the most likely norm.

(3) C_{IN}, C_{VOULT}, C₁, and C₂ : Low-ESR surface-mount ceramic capacitors (MLCCs) used in setting electrical characteristics

(4) For the two groups of current sinks on a part (GroupA and GroupB), the following are determined: the maximum sink current in the group (MAX), the minimum sink current in the group (MIN), and the average sink current of the group (AVG). For each group, two matching numbers are calculated: (MAX-AVG)/AVG and (AVG-MIN)/AVG. The largest number of the two (worst case) is considered the matching figure for the Group. The matching figure for a given part is considered to be the highest matching figure of the two Groups. The typical specification provided is the most likely norm of the matching figure for all parts.

(5) For each Dxxpin, headroom voltage is the voltage across the internal current sink connected to that pin. For Group A, B, and C current sinks, V_{HRx} = V_{OUT} – V_{LED}. If headroom voltage requirement is not met, LED current regulation will be compromised.

Electrical Characteristics (continued)

Typical limits are $T_A = 25^\circ\text{C}$, and minimum and maximum limits in apply over the full operating temperature range (-30°C to $+85^\circ\text{C}$). Unless otherwise specified: $V_{IN} = 3.6\text{ V}$; $V_{HWEN} = V_{IN}$; $V_{PWM} = 0\text{ V}$; $V_{DxA} = V_{DxB} = V_{DxC} = 0.4\text{ V}$; GroupA = GroupB = GroupC = full-scale current; ENxA, ENxB, ENxC bits = 1; 53A, 62A bits = 0; $C1 = C2 = C_{IN} = C_{OUT} = 1\text{ }\mu\text{F}$.⁽¹⁾⁽²⁾⁽³⁾

PARAMETER		TEST CONDITIONS	MIN	TYP	MAX	UNIT
R_{OUT}	Open-loop charge pump output resistance	Gain = 3/2		2.4		Ω
		Gain = 1		0.5		
I_Q	Quiescent supply current	Gain = 3/2, no load		2.86	4.38	mA
		Gain = 1, no load		1.09	2.31	
I_{SB}	Standby supply current	$2.7\text{ V} \leq V_{IN} \leq 5.5\text{ V}$ HWEN = V_{IN} , all ENx bits = 0		1.7	4	μA
I_{SD}	Shutdown supply current	$2.7\text{ V} \leq V_{IN} \leq 5.5\text{ V}$ HWEN = 0 V, All ENx bits = 0		1.7	4	μA
f_{SW}	Switching frequency		1.1	1.33	1.56	MHz
t_{START}	Start-up time	$V_{OUT} = 90\%$ steady state		250		μs
V_{ALS}	ALS reference voltage accuracy		0.95 (-5%)	1	1.05 5%	V
R_{ALS}	ALS resistor accuracy	$R_{ALS} = 9.08\text{ k}\Omega$		-9%	9%	
		$R_{ALS} = 5.46\text{ k}\Omega$		-9%	9%	
V_{HWEN}	HWEN voltage thresholds	$2.7\text{ V} \leq V_{IN} \leq 5.5\text{ V}$	Reset	0	0.45	V
			Normal operation	1.2	V_{IN}	
V_{PWM}	PWM voltage thresholds	$2.7\text{ V} \leq V_{IN} \leq 5.5\text{ V}$	Diodes off	0	0.45	V
			Diodes on	1.2	V_{IN}	
V_{OL-INT}	Interrupt output logic low 0	$I_{LOAD} = 3\text{ mA}$			400	mV
I²C-COMPATIBLE INTERFACE VOLTAGE SPECIFICATIONS (SCL, SDIO)						
V_{IL}	Input logic low 0	$2.7\text{ V} \leq V_{IN} \leq 5.5\text{ V}$	0		0.45	V
V_{IH}	Input logic high 1	$2.7\text{ V} \leq V_{IN} \leq 5.5\text{ V}$	1.2		V_{IN}	V
V_{OL}	SDIO output logic low 0	$I_{LOAD} = 3\text{ mA}$			400	mV
I²C-COMPATIBLE INTERFACE TIMING SPECIFICATIONS (SCL, SDIO)						
t_1	SCL (clock period)	See ⁽⁶⁾	2.5			μs
t_2	Data in setup time to SCL high		100			ns
t_3	Data out stable after SCL low		0			ns
t_4	SDIO low setup time to SCL low (start)		100			ns
t_5	SDIO high hold time after SCL high (stop)		100			ns

(6) SCL is tested with a 50% duty-cycle clock.

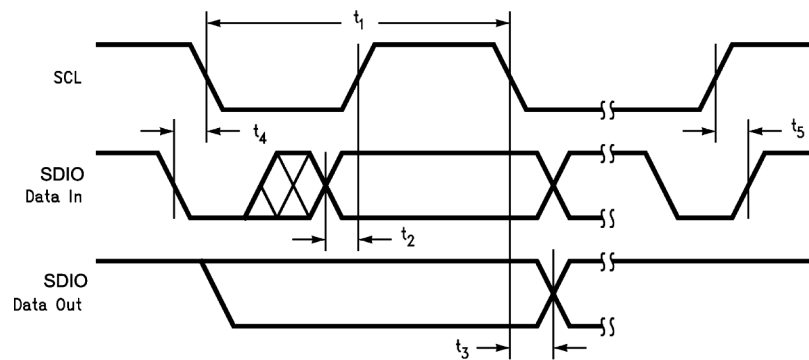

Figure 1. I²C Timing Diagram

6.6 Typical Characteristics

Unless otherwise specified: $T_A = 25^\circ\text{C}$; $V_{IN} = 3.6\text{ V}$; $V_{HWEN} = V_{IN}$; $C_{IN} = 1\ \mu\text{F}$, $C_{OUT} = 1\ \mu\text{F}$, $C_1 = C_2 = 1\ \mu\text{F}$.

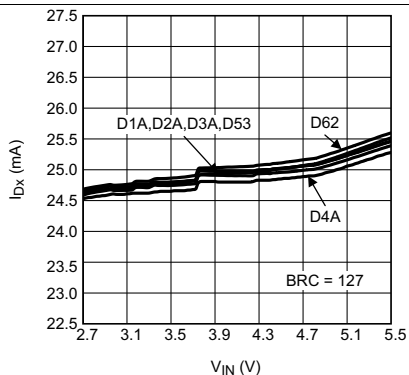

Figure 2. I_{LED} vs Input Voltage 6 LEDs

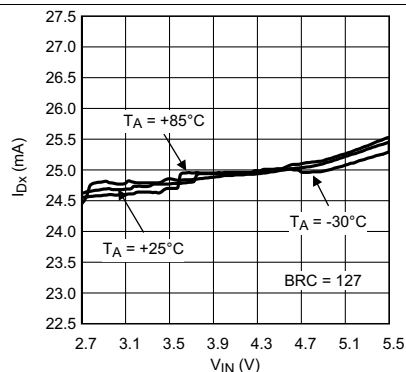

Figure 3. I_{LED} vs Input Voltage

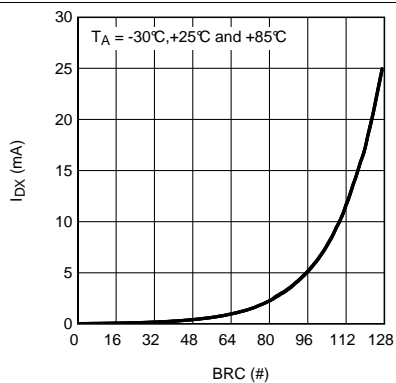

Figure 4. I_{LED} vs Brightness Code Linear Scale

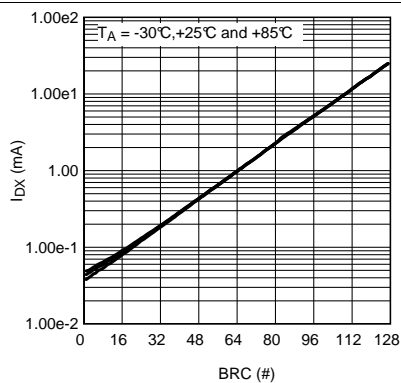

Figure 5. I_{LED} vs Brightness Code Log Scale

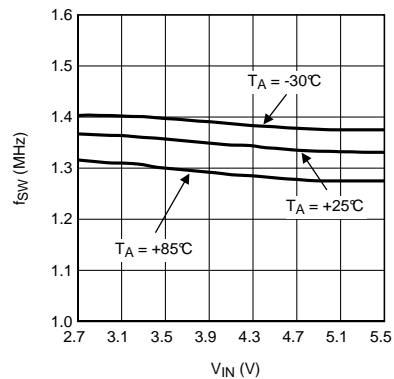

Figure 6. Switching Frequency vs Input Voltage Tri-Temp

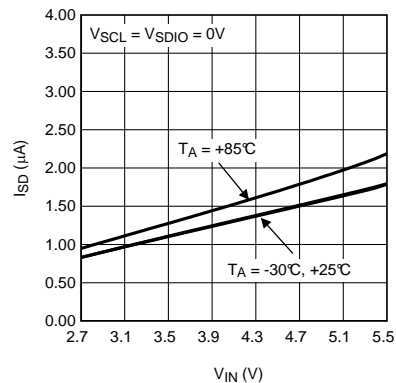

Figure 7. Shutdown Current vs Input Voltage $V_{IO} = 0\text{ V}$

Typical Characteristics (continued)

Unless otherwise specified: $T_A = 25^\circ\text{C}$; $V_{IN} = 3.6\text{ V}$; $V_{HWEN} = V_{IN}$; $C_{IN} = 1\ \mu\text{F}$, $C_{OUT} = 1\ \mu\text{F}$, $C_1 = C_2 = 1\ \mu\text{F}$.

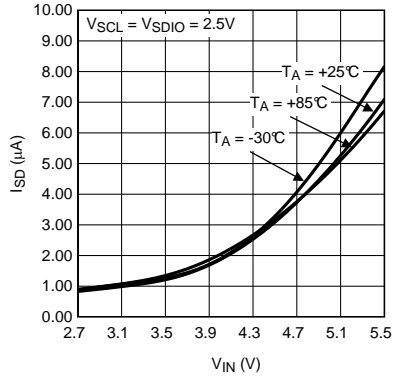

Figure 8. Shutdown Current vs Input Voltage $V_{I0} = 2.5\text{ V}$

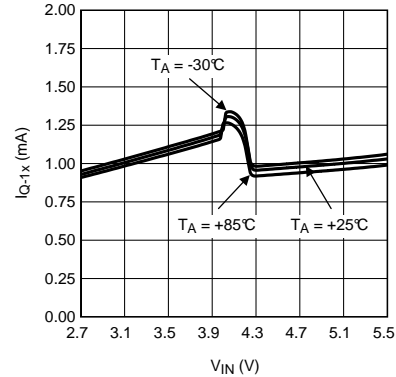

Figure 9. Quiescent Current vs Input Voltage 1x Gain

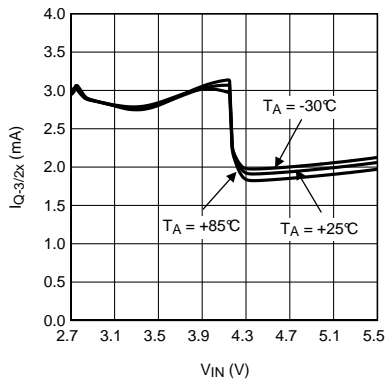

Figure 10. Quiescent Current vs Input Voltage 3/2x Gain

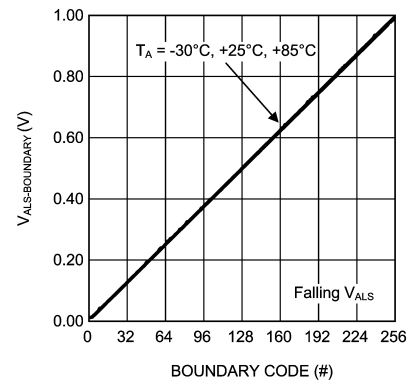

Figure 11. ALS Boundary Voltage vs Boundary Code Falling ALS Voltage

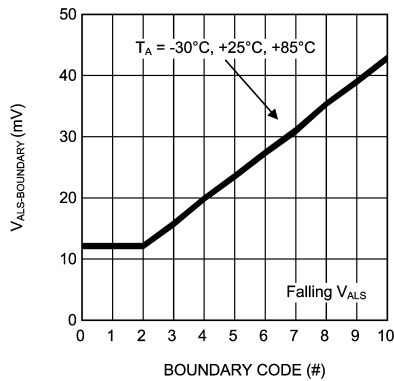

Figure 12. ALS Boundary Voltage vs Boundary Code Falling ALS Voltage (Zoom)

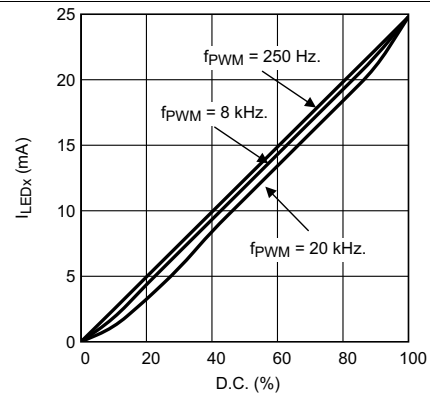

Figure 13. Diode Current vs PWM Duty Cycle

Typical Characteristics (continued)

Unless otherwise specified: $T_A = 25^\circ\text{C}$; $V_{IN} = 3.6\text{ V}$; $V_{HWEN} = V_{IN}$; $C_{IN} = 1\ \mu\text{F}$, $C_{OUT} = 1\ \mu\text{F}$, $C_1 = C_2 = 1\ \mu\text{F}$.

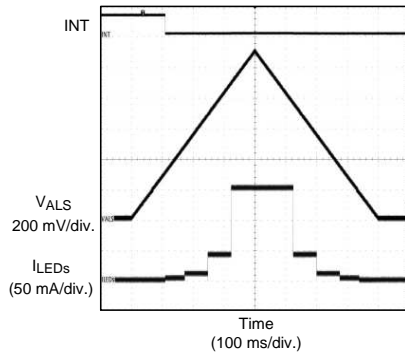

Figure 14. Ambient Light Sensor Response

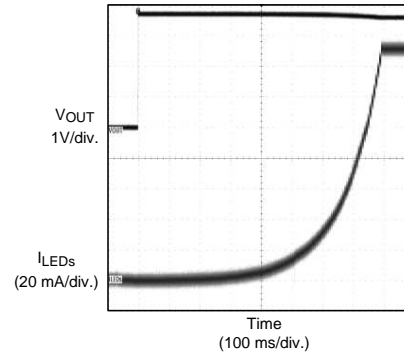

Figure 15. Diode Current Ramp-Up $T_{STEP} = 6\text{ ms}$

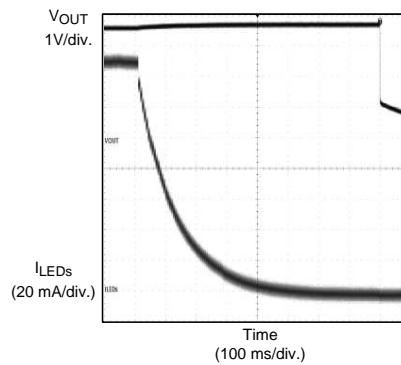

Figure 16. Diode Current Ramp-Down $T_{STEP} = 6\text{ ms}$

7 Detailed Description

7.1 Overview

The LM3535 is a white LED driver system based upon an adaptive 3/2x – 1x CMOS charge pump capable of supplying up to 200 mA of total output current. With three separately controlled groups of constant current sinks, the LM3535 is an ideal solution for platforms requiring a single white LED driver IC for main display, sub display, and indicator lighting. The tightly matched current sinks ensure uniform brightness from the LEDs across the entire small-format display.

Each LED is configured in a common anode configuration, with the peak drive current set to 25 mA. An I²C compatible interface is used to enable the device and vary the brightness within the individual current sink Groups. For GroupA, 128 exponentially-spaced analog brightness control levels are available. GroupB and GroupC have 8 linearly-spaced analog brightness levels.

Additionally, the LM3535 provides 1 input for an ambient light sensor to adaptively adjust the diode current based on ambient conditions, and a PWM pin to allow the diode current to be pulse width modulated to work with a display driver utilizing dynamic or content adjusted backlight control (DBC or CABG).

7.2 Functional Block Diagram

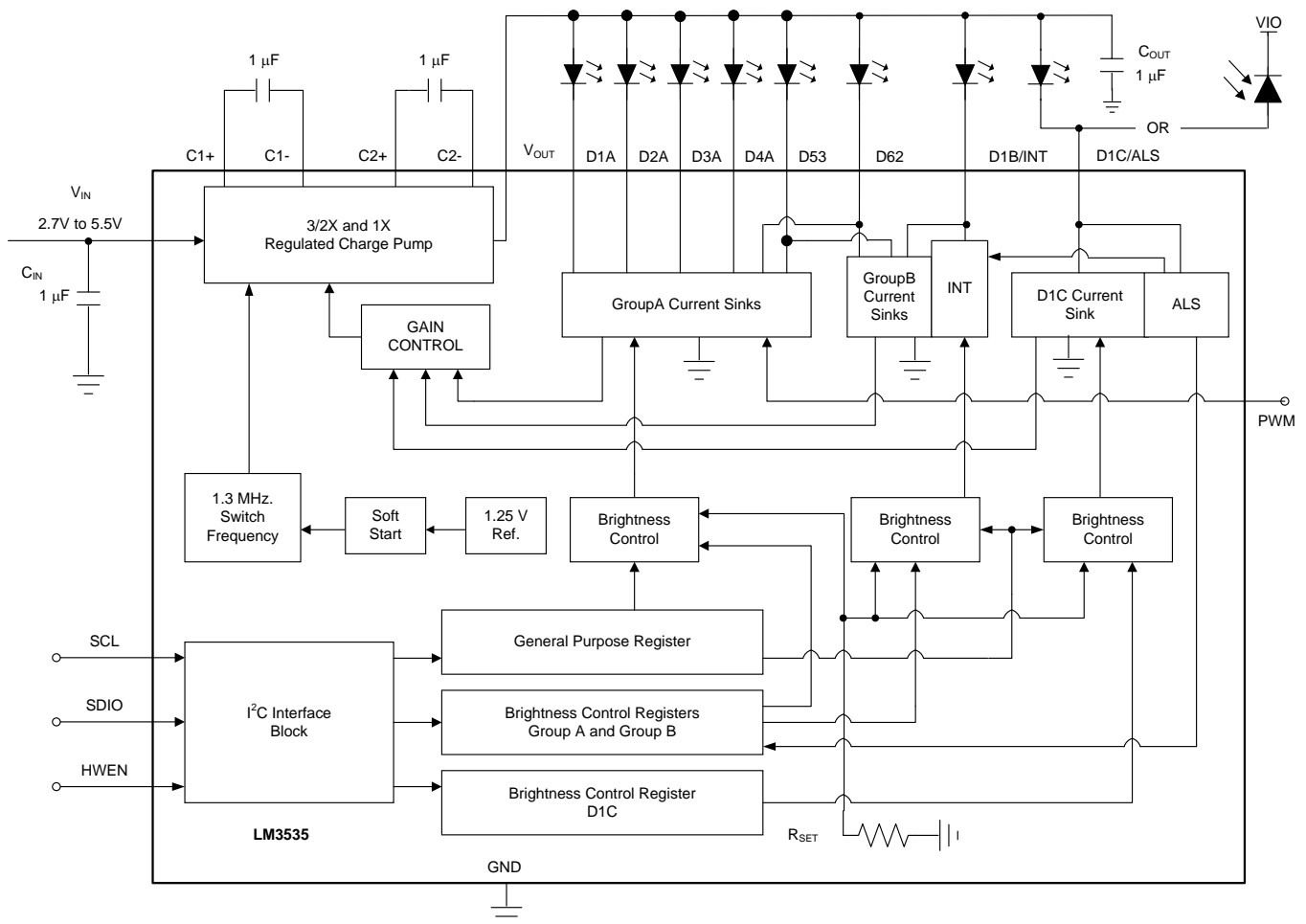

7.3 Feature Description

7.3.1 Charge Pump

The input to the 3/2x or 1x charge pump is connected to the V_{IN} pin, and the regulated output of the charge pump is connected to the V_{OUT} pin. The recommended input voltage range of the LM3535 is 2.7 V to 5.5 V. The device regulated charge pump has both open loop and closed loop modes of operation. When the device is in open loop, the voltage at V_{OUT} is equal to the gain times the voltage at the input. When the device is in closed loop, the voltage at V_{OUT} is regulated to 4.3 V (typical). The charge pump gain transitions are actively selected to maintain regulation based on LED forward voltage and load requirements.

7.3.2 Diode Current Sinks

Matched currents are ensured with the use of tightly matched internal devices and internal mismatch cancellation circuitry. There are eight regulated current sinks configurable into 3 different lighting regions.

7.3.3 Ambient Light Sensing (ALS) And Interrupt

The LM3535 provides an ambient light sensing input for use with ambient backlight control. By connecting the anode of a photo diode / sensor to the sensor input pins, and configuring the appropriate ALS resistors, the LM3535 can be configured to adjust the diode current to five unique settings, corresponding to four adjustable light region trip points. Additionally, when the LM3535 determines that an ambient condition has changed, the interrupt pin, when connected to a pullup resistor toggles to a 0 alerting the controller. See [I²C Compatible Interface](#) for more details regarding the register configurations.

7.3.4 Dynamic Backlight Control Input (PWM Pin)

The pulse width modulation (PWM) pin allows a display driver utilizing dynamic backlight control (DBC) to adjust the LED brightness based on the content. The PWM input can be turned on or off (Acknowledge or Ignore), and the polarity can be flipped (active high or active low) through the I2C interface. The current sinks of the LM3535 require approximately 15 μ s to reach steady-state target current. This turnon time sets the minimum usable PWM pulse width for DBC/CABC.

7.3.5 LED Forward Voltage Monitoring

The LM3535 has the ability to switch gains (1x or 3/2x) based on the forward voltage of the LED load. This ability to switch gains maximizes efficiency for a given load. Forward voltage monitoring occurs on all diode pins. At higher input voltages, the LM3535 operates in pass mode, allowing the V_{OUT} voltage to track the input voltage. As the input voltage drops, the voltage on the Dxx pins also drops ($V_{DXX} = V_{VOUT} - V_{LEDx}$). Once any of the active Dxx pins reaches a voltage approximately equal to 130 mV, the charge pump will switch to the gain of 3/2. This switchover ensures that the current through the LEDs never becomes pinched off due to a lack of headroom across the current sinks. *Once a gain transition occurs, the LM3535 remains in the gain of 3/2 until an I²C write to the part occurs. At that time, the LM3535 re-evaluates the LED conditions and selects the appropriate gain.*

Only active Dxx pins are monitored.

7.3.6 Configurable Gain Transition Delay

To optimize efficiency, the LM3535 has a user selectable gain transition delay that allows the part to ignore short duration input voltage drops. By default, the LM3535 does not change gains if the input voltage dip is shorter than 3 to 6 milliseconds. There are three selectable gain transition delay ranges available on the LM3535. All delay ranges are set within the VF Monitor Delay Register. See [Internal Registers of LM3535](#) for more information regarding the delay ranges.

7.3.7 Hardware Enable (HWEN)

The LM3535 has a hardware enable/reset pin (HWEN) that allows the device to be disabled by an external controller without requiring an I²C write command. Under normal operation, hold the HWEN pin high (logic 1) to prevent an unwanted reset. When the HWEN is driven low (logic 0), all internal control registers reset to the default states, and the device becomes disabled. See the [Electrical Characteristics](#) section of the data sheet for required voltage thresholds.

7.4 Device Functional Modes

7.4.1 Shutdown

The LM3535 enters shutdown mode if HWEN pin is held low. In this mode, the LM3535 has a shutdown current of 1.7 μA . I2C communication is not possible when in shutdown.

7.4.2 Standby

The LM3535 enters standby mode if HWEN pin is held high and when the ENx bits are set to 0. In this mode, the LM3535 has a standby current of 1.7 μA . I2C communication is possible when in standby.

7.4.3 Active Mode

The LM3535 enters active mode if HWEN pin is held high and when any of the ENx bits are set to 1. When the LM3535 is in pass-mode operation, the typical quiescent current drawn is 1.09 mA. When the LM3535 is in boost-mode operation, the typical quiescent current drawn is 2.86 mA. I2C communication is possible when in active mode.

7.5 Programming

7.5.1 I²C Compatible Interface

7.5.1.1 Data Validity

The data on SDIO line must be stable during the HIGH period of the clock signal (SCL). In other words, state of the data line can only be changed when SCL is LOW.

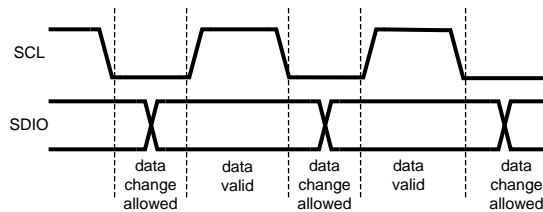

Figure 17. Data Validity Diagram

A pullup resistor between the VIO line and SDIO of the controller must be greater than $[(VIO - V_{OL}) / 3 \text{ mA}]$ to meet the V_{OL} requirement on SDIO. Using a larger pullup resistor results in lower switching current with slower edges, while using a smaller pullup results in higher switching currents with faster edges.

7.5.1.2 Start and Stop Conditions

START and STOP conditions classify the beginning and the end of the I²C session. A START condition is defined as SDIO signal transitioning from HIGH to LOW while SCL line is HIGH. A STOP condition is defined as the SDIO transitioning from LOW to HIGH while SCL is HIGH. The I²C master always generates START and STOP conditions. The I²C bus is considered to be busy after a START condition and free after a STOP condition. During data transmission, the I²C master can generate repeated START conditions. First START and repeated START conditions are equivalent, function-wise.

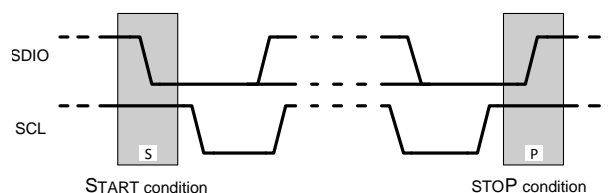

Figure 18. Start and Stop Conditions

Programming (continued)

7.5.1.3 Transferring Data

Every byte put on the SDIO line must be eight bits long, with the most significant bit (MSB) transferred first. Each byte of data has to be followed by an acknowledge bit. The acknowledge related clock pulse is generated by the master. The master releases the SDIO line (HIGH) during the acknowledge clock pulse. The LM3535 pulls down the SDIO line during the 9th clock pulse, signifying an acknowledge. The LM3535 generates an acknowledge after each byte is received. There is no acknowledge created after data is read from the LM3535.

After the START condition, the I²C master sends a chip address. This address is seven bits long followed by an eighth bit which is a data direction bit (R/W). The LM3535 7-bit address is 38h. For the eighth bit, a “0” indicates a WRITE and a “1” indicates a READ. The second byte selects the register to which the data will be written. The third byte contains data to write to the selected register.

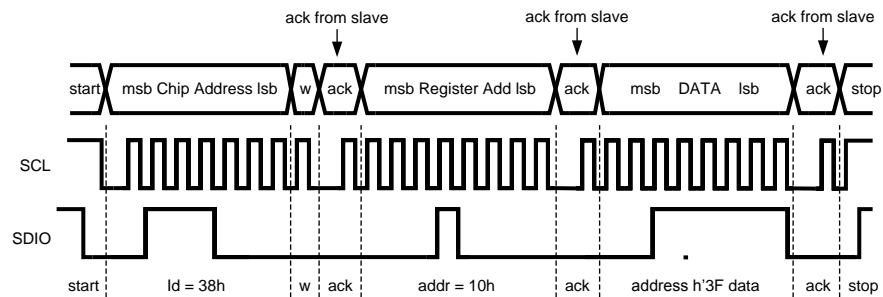

Figure 19. Write Cycle
W = Write (SDIO = 0)
R = Read (SDIO = 1)
Ack = Acknowledge (SDIO Pulled Down by Either Master or Slave)
ld = Chip Address, 38h For Lm3535

7.5.1.4 I²C Compatible Chip Address

The 7-bit chip address for LM3535 is 111000, or 0x38.

7.5.1.5 Internal Registers of LM3535

REGISTER	INTERNAL HEX ADDRESS	POWER ON VALUE
Diode Enable Register	0x10	0000 0000 (0x00)
Configuration Register	0x20	0000 0000 (0x00)
Options Register	0x30	0000 0000 (0x00)
ALS Zone Readback	0x40	1111 0000 (0xF0)
ALS Control Register	0x50	0000 0011 (0x03)
ALS Resistor Register	0x51	0000 0000 (0x00)
ALS Zone Boundary #0	0x60	0011 0011 (0x33)
ALS Zone Boundary #1	0x61	0110 0110 (0x66)
ALS Zone Boundary #2	0x62	1001 1001 (0x99)
ALS Zone Boundary #3	0x63	1100 1100 (0xCC)
ALS Brightness Zone #1	0x70	1001 1001 (0x99)
ALS Brightness Zone #2	0x71	1011 0110 (0xB6)
ALS Brightness Zone #3	0x72	1100 1100 (0xCC)
ALS Brightness Zone #4	0x73	1110 0110 (0xE6)
ALS Brightness Zone #5	0x74	1111 1111 (0xFF)
Group A Brightness Control Register	0xA0	1000 0000 (0x80)
Group B Brightness Control Register	0xB0	1100 0000 (0xC0)
Group C Brightness Control Register	0xC0	1111 1000 (0xF8)

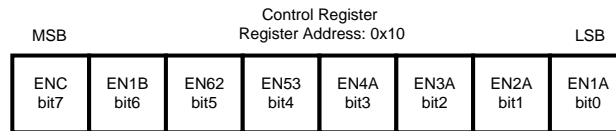

Figure 20. Diode Enable Register Description
Internal Hex Address: 0x10

Each ENx Bit controls the state of the corresponding current sink. Writing a 1 to these bits enables the current sinks. Writing a 0 disables the current sinks. In order for current to begin flowing through the BankA current sinks, the brightness codes stored in either the BankA Brightness register or the ALS Brightness registers (with ALS enabled) must be non-zero. The BankA current sinks can be disabled in two different manners. Writing 0 to the ENx bits when the current sinks are active will disable the current sinks without going through the ramp down sequence. Additionally, setting the BankA brightness code to 0 when the current sinks are active (ENx = 1) does force the diode current to ramp down. All ramping behavior is tied to the BankA Brightness or ALS Brightness Register settings. Any change in these values causes the LM3535 brightness state machine to ramp the diode current.

Writing a '1 to ENC, EN1B, EN62 and EN53 (when EN62 and EN53 are assigned to BankB) by default enables the corresponding current sinks and drive the LEDs to the current value stored in the BankB and BankC brightness registers. Writing a 0 to these bits immediately disables the current sinks.

The ENC and EN1B bits are ignored if the D1C/ALS pin is configured as an ALS input and if the D1B/INT is configured as an interrupt flag.

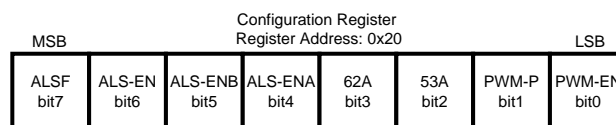

Figure 21. Configuration Register Description
Internal Hex Address: 0x20

- PWM-EN: PWM Input Enable. Writing a 1 = Enable, and a 0 = Ignore (default).
- PWM-P: PWM Input Polarity. Writing a 0 = Active High (default) and a 1 = Active Low.
- 53A: Assign D53 diode to BankA. Writing a 0 assigns D53 to BankB (default) and a 1 assigns D53 to BankA.
- 62A: Assign D62 diode to BankA. Writing a 0 assigns D62 to BankB (default) and a 1 assigns D62 to BankA.
- ALS-ENA: Enable ALS on BankA. Writing a 1 enables ALS control of diode current and a 0 (default) forces the BankA current to the value stored in the BankA brightness register. The ALS-EN bit must be set to a 1 for the ALS block to control the BankA brightness.
- ALS-ENB: Enable ALS on BankB. Writing a 1 enables ALS control of diode current and a 0 (default) forces the BankB current to the value stored in the BankB brightness register. The ALS-EN bit must be set to a 1 for the ALS block to control the BankB brightness. The ALS function for BankB is different than bankA in that the ALS will only enable and disable the BankB diodes depending on the ALS zone chosen by the user. BankA utilizes the 5 different zone brightness registers (Addresses 0x70 to 0x74).
- ALS-EN: Enables ALS monitoring. Writing a 1 enables the ALS monitoring circuitry and a 0 disables it. This feature can be enabled without having the current sinks or charge pump active. The ALS value is updated in register 0x40 (ALS Zone Register)
- ALSF: ALS Interrupt Enable. Writing a 1 sets the D1B/INT pin to the ALS interrupt pin and writing a 0 (default) sets the pin to a BankB current sink.

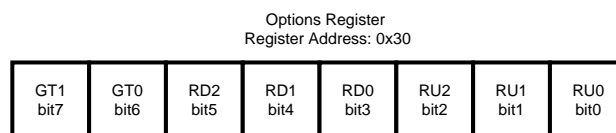

Figure 22. Options Register
Internal Hex Address: 0x30

- RD0-RD2: Diode Current Ramp Down Step Time. : '000' = 6 μs, '001' = 0.77 ms, '010' = 1.5 ms, '011' = 3 ms, '100' = 6 ms, '101' = 12 ms, '110' = 25ms, '111' = 50ms
- RU0-RU2: Diode Current Ramp Up Step Time. : '000' = 6 μs, '001' = 0.77 ms, '010' = 1.5 ms, '011' = 3 ms, '100' = 6 ms, '101' = 12 ms, '110' = 25ms, '111' = 50ms
- GT0-GT1: Gain Transition Filter. The value stored in this register determines the filter time used to make a gain transition in the event of an input line step. Filter times = '00' = 3-6 ms, '01' = 0.8-1.5 ms, '10' = 20 μs, **On LM3535-2ALS, '11' = 1μs, On LM3535, '11' = DO NOT USE**

The Ramp-Up and Ramp-Down times follow the equations: $T_{RAMP} = (N_{Start} - N_{Target}) \times \text{Ramp-Step Time}$

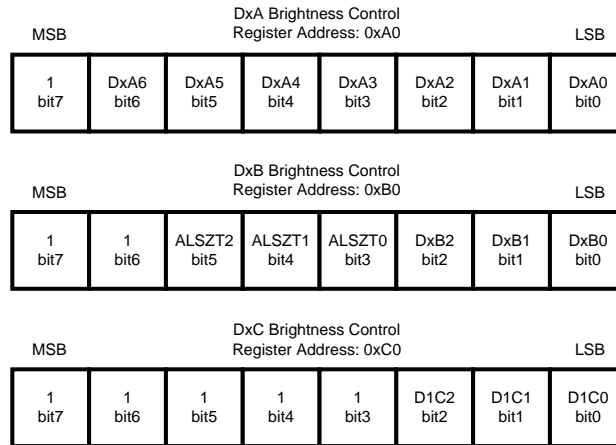

Figure 23. Brightness Control Register Description
Internal Hex Address: 0xa0 (Groupa), 0xb0 (Groupb), 0xc0 (Groupc)

NOTE

DxA6-DxA0: Sets Brightness for DxA pins (GroupA). 1111111 = Fullscale. Code 0 in this register disables the BankA current sinks.

DxB2-DxB0: Sets Brightness for DxB pins (GroupB). 111 = Fullscale

ALSZT2-ALSZT0: Sets the Brightness Zone boundary used to enable and disable BankB diodes based upon ambient lighting conditions.

DxC2-DxC0: Sets Brightness for D1C pin. 111 = Fullscale

The BankA Current can be approximated by Equation 1 where N = BRC = the decimal value stored in either the BankA Brightness Register or the five different ALS Zone Brightness Registers:

$$I_{LED} \text{ (mA)} \approx 25 \times 0.85^{[44 - ((N+1)/2.91)]}$$

Or

$$BRC \text{ (\#)} \approx 127 + 17.9 \times \text{LN}(I_{LED(\text{mA})}/25 \text{ mA}) \tag{1}$$

Table 1. I_{LED} vs Brightness Register Data

BankA or ALS Brightness Data	% of I _{LED_MAX}	BankA or ALS Brightness Data	% of I _{LED_MAX}	BankA or ALS Brightness Data	% of I _{LED_MAX}	BankA or ALS Brightness Data	% of I _{LED_MAX}
0000000	0.000%	0100000	0.803%	1000000	4.078%	1100000	20.713%
0000001	0.166%	0100001	0.845%	1000001	4.290%	1100001	21.792%
0000010	0.175%	0100010	0.889%	1000010	4.514%	1100010	22.928%
0000011	0.184%	0100011	0.935%	1000011	4.749%	1100011	24.122%
0000100	0.194%	0100100	0.984%	1000100	4.996%	1100100	25.379%
0000101	0.204%	0100101	1.035%	1000101	5.257%	1100101	26.701%
0000110	0.214%	0100110	1.089%	1000110	5.531%	1100110	28.092%
0000111	0.226%	0100111	1.146%	1000111	5.819%	1100111	29.556%
0001000	0.237%	0101000	1.205%	1001000	6.122%	1101000	31.096%
0001001	0.250%	0101001	1.268%	1001001	6.441%	1101001	32.716%
0001010	0.263%	0101010	1.334%	1001010	6.776%	1101010	34.420%
0001011	0.276%	0101011	1.404%	1001011	7.129%	1101011	36.213%
0001100	0.291%	0101100	1.477%	1001100	7.501%	1101100	38.100%
0001101	0.306%	0101101	1.554%	1001101	7.892%	1101101	40.085%
0001110	0.322%	0101110	1.635%	1001110	8.303%	1101110	42.173%
0001111	0.339%	0101111	1.720%	1001111	8.735%	1101111	44.371%
0010000	0.356%	0110000	1.809%	1010000	9.191%	1110000	46.682%
0010001	0.375%	0110001	1.904%	1010001	9.669%	1110001	49.114%
0010010	0.394%	0110010	2.003%	1010010	10.173%	1110010	51.673%
0010011	0.415%	0110011	2.107%	1010011	10.703%	1110011	54.365%
0010100	0.436%	0110100	2.217%	1010100	11.261%	1110100	57.198%
0010101	0.459%	0110101	2.332%	1010101	11.847%	1110101	60.178%
0010110	0.483%	0110110	2.454%	1010110	12.465%	1110110	63.313%
0010111	0.508%	0111011	2.582%	1010111	13.114%	1110111	66.611%
0011000	0.535%	0110111	2.716%	1011000	13.797%	1111000	70.082%
0011001	0.563%	0111000	2.858%	1011001	14.516%	1111001	73.733%
0011010	0.592%	0111001	3.007%	1011010	15.272%	1111010	77.574%
0011011	0.623%	0111010	3.163%	1011011	16.068%	1111011	81.616%
0011100	0.655%	0111011	3.328%	1011100	16.905%	1111100	85.868%
0011101	0.689%	0111100	3.502%	1011101	17.786%	1111101	90.341%
0011110	0.725%	0111101	3.684%	1011110	18.713%	1111110	95.048%
0011111	0.763%	0111111	3.876%	1011111	19.687%	1111111	100.000%

GroupB and GroupC Brightness Levels = 2.5, 5, 7.5, 10, 12.5, 15, 17.5, 25mA

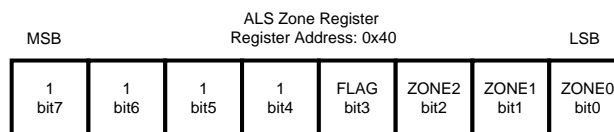

Figure 24. Als Zone Register Description
Internal Hex Address: 0x40

- ZONE0-ZONE2: ALS Zone information: '000' = Zone0, '001' = Zone1, '010' = Zone2, '011' = Zone3, '100' = Zone4. Other combinations not used
- FLAG: ALS Transition Flag. 1 = Transition has occurred. 0 = No Transition. The FLAG bit is cleared once the 0x40 register has been read.

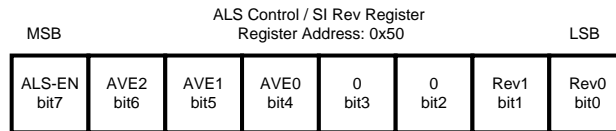

Figure 25. ALS Control / Silicon Revision Register Description
Internal Hex Address: 0x50

- Rev0-Rev1 : Stores the Silicon Revision value. LM3535 = 11
- AVE2-AVE0: Sets Averaging Time for ALS sampling. Need two to three Averaging periods to make transition decision. 000 = 25 ms, 001 = 50 ms, 010 = 100 ms 011 = 200 ms, 100 = 400 ms, 101 = 800 ms 110 = 1.6 s, 111 = 3.2s

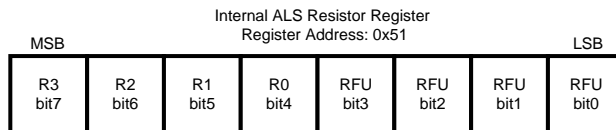

Figure 26. ALS Resistor Control Register Description
Internal Hex Address: 0x51

- R0-R3: Sets the internal ALS resistor value

Table 2. Internal ALS Resistor Table

R3	R2	R1	R0	ALS RESISTOR VALUE (Ω)
0	0	0	0	High Impedance
0	0	0	1	13.6 k
0	0	1	0	9.08 k
0	0	1	1	5.47 k
0	1	0	0	2.32 k
0	1	0	1	1.99 k
0	1	1	0	1.86 k
0	1	1	1	1.65 k
1	0	0	0	1.18 k
1	0	0	1	1.1 k
1	0	1	0	1.06 k
1	0	1	1	986
1	1	0	0	804
1	1	0	1	764
1	1	1	0	745
1	1	1	1	711

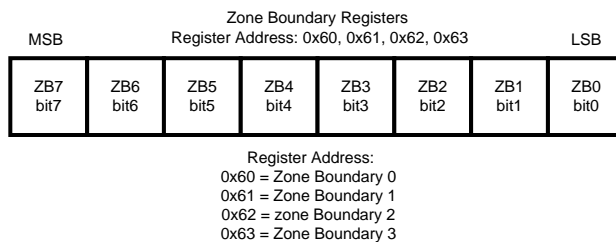

Figure 27. Zone Boundary Register Descriptions

- ZB7-ZB0: Sets Zone Boundary Lines with a Falling ALS voltage.
 - 0xFF w/ ALS Falling = 992.3 mV (typical).

- $V_{TRIP-LOW} (typ) = [Boundary\ Code \times 3.874mV] + 4.45mV$
- For boundary codes 2 to 255. Code 0 and Code1 are mapped to equal the Code2 value.
- Each zone line has approx. 5.5mV of hysteresis between the falling and rising ALS trip points.
- Zone Boundary 0 is the line between ALS Zone 0 and Zone 1. Default Code = 0x33 or approximately 200 mV
- Zone Boundary 1 is the line between ALS Zone 1 and Zone 2. Default Code = 0x66 or approximately 400 mV
- Zone Boundary 2 is the line between ALS Zone 2 and Zone 3. Default Code = 0x99 or approximately 600 mV
- Zone Boundary 3 is the line between ALS Zone 3 and Zone 4. Default Code = 0xCC or approximately 800 mV

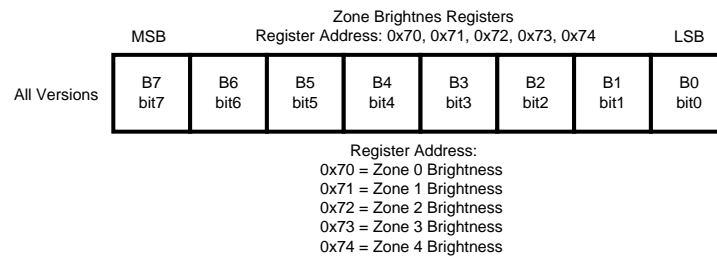

Figure 28. Zone Brightness Region Register Description

- B7-B0: Sets the ALS Zone Brightness Code. B7 always = 1 (unused). Use the formula found in the BankA Brightness Register Description ([Figure 23](#)) to set the desired target brightness. Default values can be overwritten
- Zone0 Brightness Address = 0x70. Default = 0x99 (25) or 0.084 mA
- Zone1 Brightness Address = 0x71. Default = 0xB6 (54) or 0.164 mA
- Zone2 Brightness Address = 0x72. Default = 0xCC (76) or 1.45 mA
- Zone3 Brightness Address = 0x73. Default = 0xE6 (102) or 6.17 mA
- Zone4 Brightness Address = 0x74. Default = 0xFF (127) or 25 mA

8 Application and Implementation

NOTE

Information in the following applications sections is not part of the TI component specification, and TI does not warrant its accuracy or completeness. TI's customers are responsible for determining suitability of components for their purposes. Customers should validate and test their design implementation to confirm system functionality.

8.1 Application Information

8.2 Typical Application

The LM3535 device is a highly integrated LED driver capable of driving 8 LEDs in parallel for large display applications. Independent LED control allows selection of a subset of the 6 main display LEDs for partial-illumination applications. In addition to the main bank of 6, the LM3535 is capable of driving an additional 2 independently controlled LEDs to support Indicator applications.

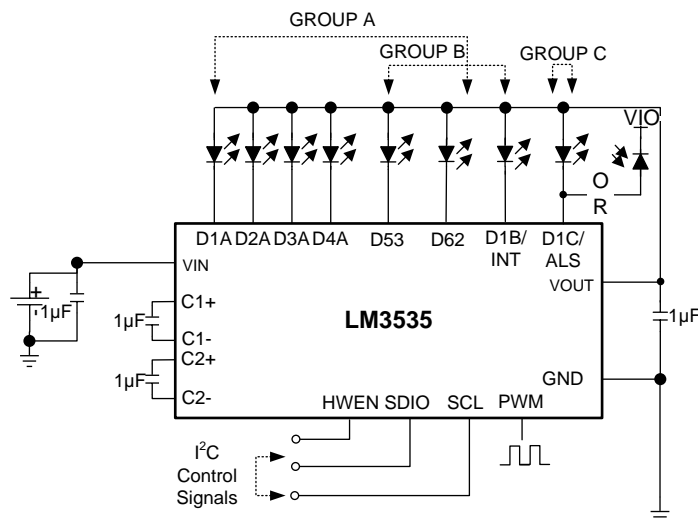

Figure 29. LM3535 Typical Application

8.2.1 Design Requirements

A detailed design procedure is described based on a design example. For this design example, use the parameters listed in Table 3 as the input parameters.

Table 3. Design Example Parameters

DESIGN PARAMETER	VALUE
Input voltage V_{IN}	2.7 V to 5.5 V
LED current maximum per channel	25 mA
Operating frequency	1.33 MHz

8.2.2 Detailed Design Procedure

8.2.2.1 Ambient Light Sensing

8.2.2.1.1 Ambient Light Sensor Block

The LM3535 incorporates an ambient light sensing interface (ALS) which translates an analog output ambient light sensor to a user specified brightness level. The ambient light sensing circuit has 4 programmable boundaries (ZB0 – ZB3) which define 5 ambient brightness zones. Each ambient brightness zone corresponds to a programmable brightness threshold (Z0T – Z4T).

Furthermore, the ambient light sensing input features 15 internal software-selectable voltage setting resistors. This allows the LM3535 the capability of interfacing with a wide selection of ambient light sensors. Additionally, the ALS inputs can be configured as high impedance, thus providing for a true shutdown during low power modes. The ALS resistors are selectable through the ALS Resistor Select Register (see [Table 2](#)). [Figure 30](#) shows a functional block diagram of the ambient light sensor input.

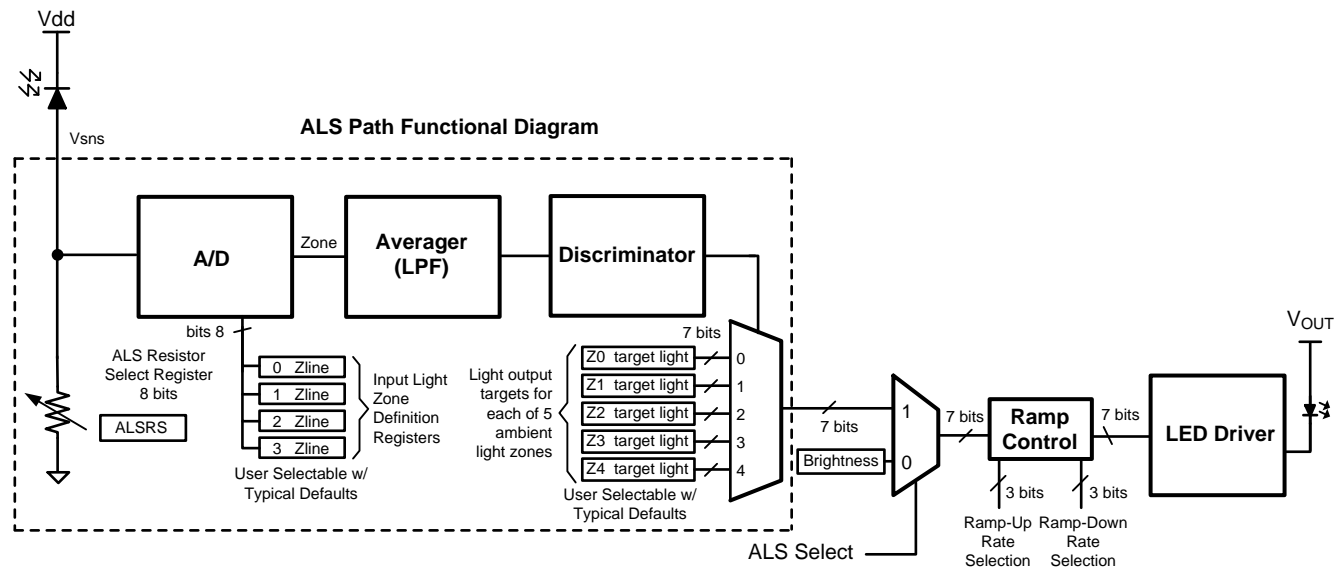

Figure 30. Ambient Light Sensor Functional Block Diagram

8.2.2.1.2 ALS Operation

The ambient light sensor input has a 0 to 1 V operational input voltage range. The [Specifications](#) shows the LM3535 with an ambient light sensor (AVAGO, APDS-9005) and the internal ALS Resistor Select Register set to 0x40 (2.32 k Ω). This circuit converts 0 to 1000 LUX light into approximately a 0 to 850 mV linear output voltage. The voltage at the active ambient light sensor input is compared against the 8 bit values programmed into the Zone Boundary Registers (ZB0 – ZB3). When the ambient light sensor output crosses one of the ZB0 – ZB3 programmed thresholds the internal ALS circuitry will smoothly transition the LED current to the new 7 bit brightness level as programmed into the appropriate Zone Target Register (Z0T – Z4T, see [Figure 28](#)).

With bits [6:4] of the Configuration Register set to 1 (Bit6 = ALS Block Enable, Bit5 = BankB ALS Enable, Bit4 = BankA ALS Enable), the LM3535 is configured for ambient light current Control. In this mode the ambient light sensing input (ALS) monitors the output of analog output ambient light sensing photo diode and adjusts the LED current depending on the ambient light. The ambient light sensing circuit has 4 configurable ambient light boundaries (ZB0 – ZB3) programmed through the four (8-bit) Zone Boundary Registers. These zone boundaries define 5 ambient brightness zones.

On start-up the 4 Zone Boundary Registers are pre-loaded with 0x33 (51d), 0x66 (102d), 0x99 (153d), and 0xCC (204d). The ALS input has a 1-V active input voltage range which makes the default Zone Boundaries approx. set at:

Zone Boundary 0 = 200 mV

Zone Boundary 1 = 400 mV

Zone Boundary 2 = 600 mV

Zone Boundary 3 = 800 mV

These Zone Boundary Registers are all 8-bit (readable and writable) registers. By default, the first zone (Z0) is defined between 0 and 200 mV, default for Z1 is defined between 200 mV and 400 mV, Z2 is defined between 400 mV and 600 mV, Z3 is defined between 600 mV and 800 mV, and Z4 is defined between 800 mV and 1 V. The default settings for the 5 Zone Target Registers are 0x19, 0x33, 0x4C, 0x66, and 0x7F. This corresponds to LED brightness settings of 84 μ A, 164 μ A, 1.45 mA, 6.17 mA and 25 mA of current, respectively. See Figure 31.

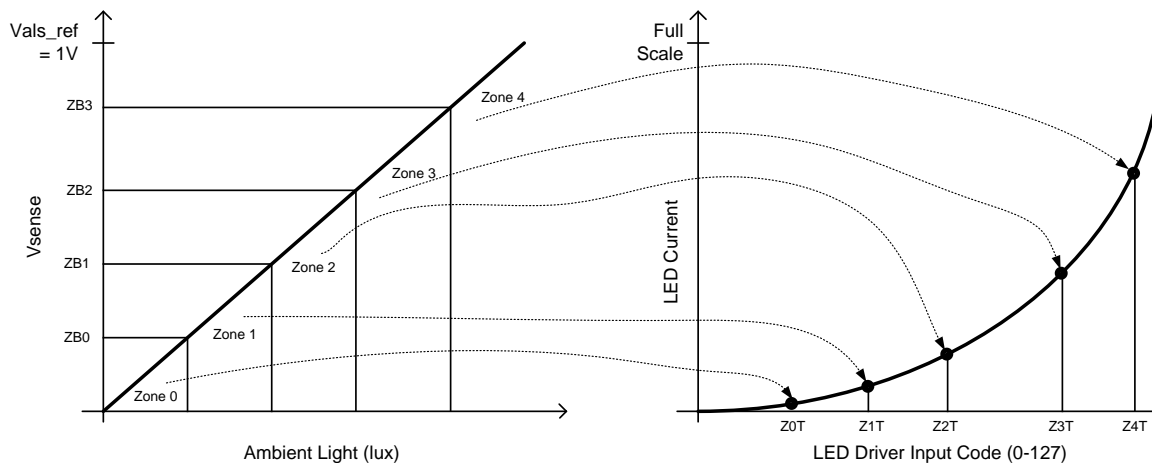

Figure 31. ALS Zone to LED Brightness Mapping

8.2.2.1.2.1 ALS Configuration Example

As an example, assume that the APDS-9005 is used as the ambient light sensing photo diode with its output connected to the ALS input. The ALS Resistor Select Register (Address 0x51) is loaded with 0x40 which configures the ALS input for a 2.32-k Ω internal pulldown resistor (see Table 2). This gives the output of the APDS-9005 a typical voltage swing of 0 to 875mV with a 0 to 1k LUX change in ambient light (0.875mV/Lux). Next, the Configuration Register (Address 0x20) is programmed with 0xDC, the ALS Control Register (Address 0x50) programmed to 0x40 and the Control Register is programmed to 0x3F . This configures the device ALS interface for:

- Ambient Light Current Control for BankA enabled
- ALS circuitry enabled
- Assigns D53 and D62 to bankA
- Sets the ALS Averaging Time to 400 ms

Next, the Control Register (Address 0x10) is programmed with 0x3F which enables the 6 LEDs via the I²C-compatible interface.

Now assume that the APDS-9005 ambient light sensor detects a 100 LUX ambient light at its input. This forces the ambient light sensor output (and the ALS input) to 87.5 mV corresponding to Zone 0. Since Zone 0 points to the brightness code programmed in Zone Target Register 0 (loaded with code 0x19), the LED current becomes:

$$I_{LED} = I_{LED_FS} \times \text{ZoneTarget0} = 25 \text{ mA} \times 0.336\% \approx 84 \mu\text{A}. \quad (2)$$

Next assume that the ambient light changes to 500 LUX (corresponding to an ALS voltage of 437.5 mV). This moves the ambient light into Zone 2 which corresponds to Zone Target Register 2 (loaded with code 0x4C) the LED current then becomes:

$$I_{LED} = I_{LED_FS} \times ZoneTarget2 = 25 \text{ mA} \times 5.781\% \approx 1.45 \text{ mA} \tag{3}$$

8.2.2.1.3 ALS Averaging Time

The ALS averaging time is the time over which the averager block collects samples from the A/D converter and then averages them to pass to the discriminator block (see Figure 32). Ambient light sensor samples are averaged and then further processed by the discriminator block to provide rejection of noise and transient signals. The averager is configurable with 8 different averaging times to provide varying amounts of noise and transient rejection (see Figure 25). The discriminator block algorithm has a maximum latency of two averaging cycles, therefore the averaging time selection determines the amount of delay that will exist between a steady state change in the ambient light conditions and the associated change of the backlight illumination. For example, the A/D converter samples the ALS inputs at 16 kHz. If the averaging time is set to 800 ms, the averager sends the updated zone information to the discriminator every 800 ms. This zone information contains the average of approximately 12800 samples (800 ms × 16 kHz). Due to the latency of 2 averaging cycles, when there is a steady-state change in the ambient light, the LED current begins to transition to the appropriate target value after approximately 1600 ms have elapsed.

The sign and magnitude of these averager outputs are used to determine whether the LM3535 should change brightness zones. The averager block follows the following rules to make a zone transition:

- The averager always begins with a Zone0 reading stored at start-up. If the main display LEDs are active before the ALS block is enabled, it is recommended that the ALS-EN bit be enabled at least 3 averaging cycles times before the ALS-ENA bit is enabled.
- The averager always rounds down to the lower zone in the case of a non-integer zone average (1.2 rounds to 1 and 1.75 also rounds to 1). Figure 32 shows an example of how the Averager will make the zone decisions for different ambient conditions.

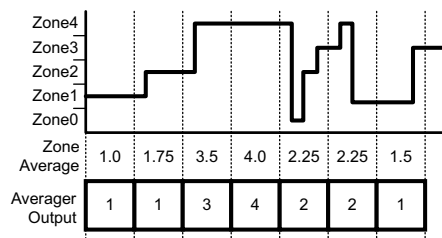

Figure 32. Averager Calculation

- The two most current averaging samples are used to make zone change decisions.
- To make a zone change, data from three averaging cycles are needed (starting value, first transition, second transition or rest).
- To Increase the brightness zone, a positive averager zone output must be followed by a second positive averager output or a repeated Averager zone. ('+' to '+' or '+' to 'Rest')
- To decrease the brightness zone, a negative averager zone output must be followed by a second negative averager output or a repeated Averager zone. ('-' to '-' or '-' to 'Rest')
- In the case of two increases or decreases in the averager output, the LM3535 transitions to zone equal to the last averager output.

Figure 33 provides a graphical representation of the behavior of the averager.

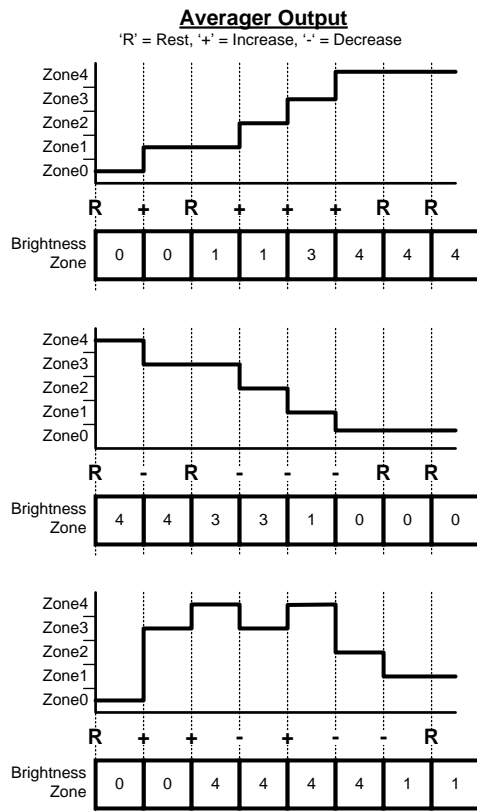

Figure 33. Brightness Zone Change Examples

Using the diagram for the ALS block (Figure 30), Figure 34 shows the flow of information starting with the A/D, transitioning to the averager, followed by the discriminator. Each state filters the previous output to help prevent unwanted zone to zone transitions.

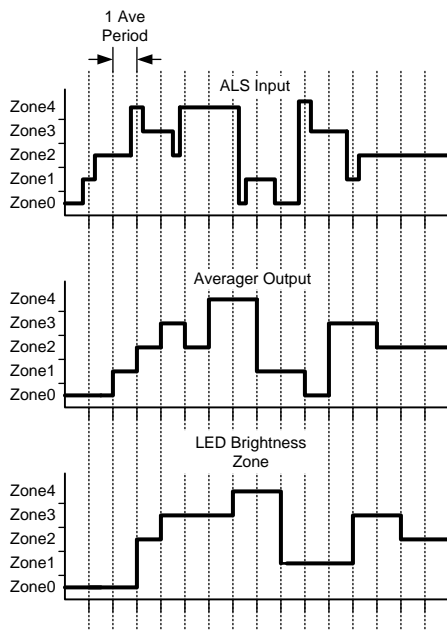

Figure 34. Ambient Light Input To Backlight Mapping

When using the ALS averaging functionality, it is important to remember that the averaging cycle is free running and is not synchronized with changing ambient lighting conditions. Due to the nature of the averager round down, an increase in brightness can take between 2 and 3 averaging cycles to change zones while a decrease in brightness can take between 1 and 2 averaging cycles to change. See [Figure 25](#) for a list of possible averager periods. [Figure 35](#) shows an example of how the perceived brightness change time can vary.

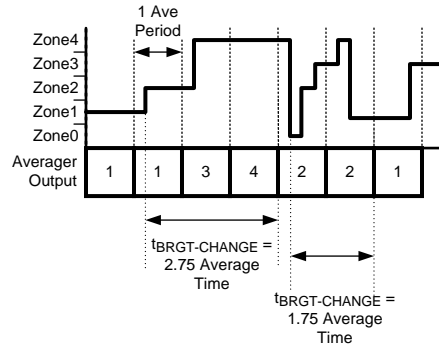
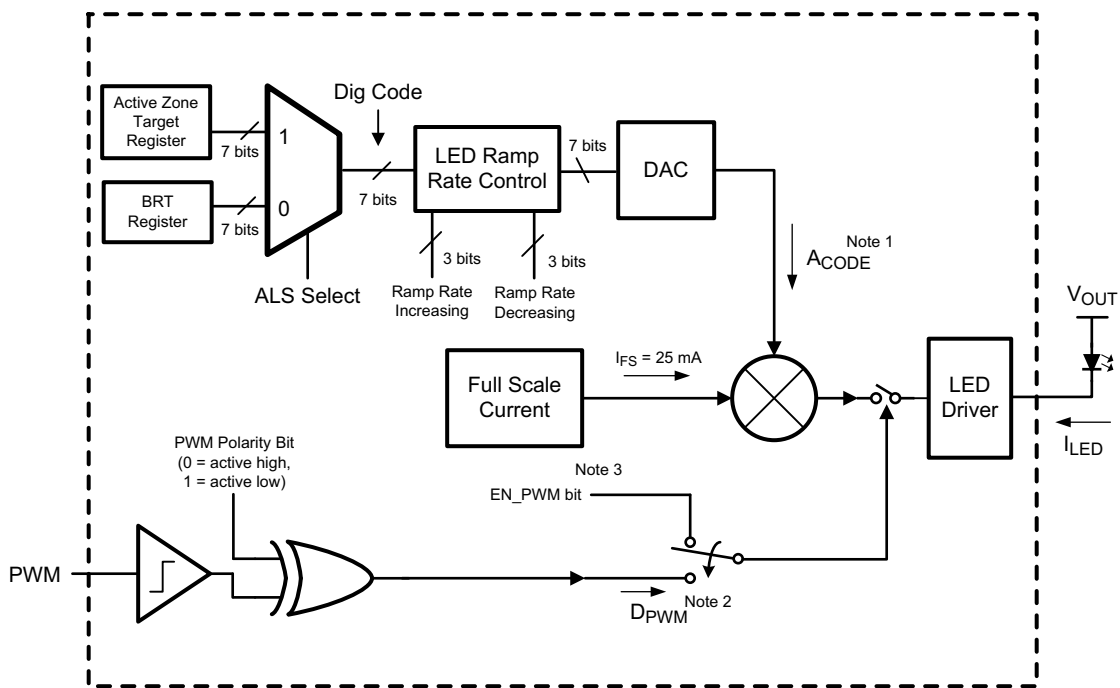

Figure 35. Perceived Brightness Change Time

8.2.2.1.4 Ambient Light Current Control + PWM

The ambient light current control can also be a function of the PWM input duty cycle. Assume the LM3535 is configured as described in the previous example, but this time the Enable PWM bit set to 1 (Configuration Register bit [0]). [Figure 36](#) shows how the different blocks (PWM and ALS) influence the LED current.



Note 1: A_{CODE} Is a Scaler between 0 and 1 based on the Brightness Data or Zone Target Data Depending on the ALS Select Bit

Note 2: D_{PWM} Is a Scaler between 0 and 1 and corresponds to the duty cycle of the PWM input signal

Note 3: For EN_PWM bit = 1
 $I_{LED} = I_{FS} \times A_{CODE} \times D_{PWM}$
 For EN_PWM bit = 0
 $I_{LED} = I_{FS} \times A_{CODE}$

Figure 36. Current Control Block Diagram

8.2.2.1.4.1 ALS + PWM Example

In this example, the APDS-9005 sensor detects that the ambient light has changed to 1 kLux. The voltage at the ALS input is now approximately 875 mV and the ambient light falls within Zone 5. This causes the LED brightness to be a function of Zone Target Register 5 (loaded with 0x7F). Now assume the PWM input is also driven with a 50% duty cycle pulsed waveform. The LED current now becomes:

$$I_{LED} = I_{LED_FS} \times ZoneTarget5 \times D = 25 \text{ mA} \times 100\% \times 50\% \approx 12.5 \text{ mA} \quad (4)$$

8.2.2.2 LED Configurations

The LM3535 has a total of 8 current sinks capable of sinking 200 mA of total diode current. These 8 current sinks are configured to operate in three independently controlled lighting regions. GroupA has four dedicated current sinks, while GroupB and GroupC each have one. To add greater lighting flexibility, the LM3535 has two additional drivers (D53 and D62) that can be assigned to either GroupA or GroupB through a setting in the general purpose register.

At start-up, the default condition is four LEDs in GroupA, three LEDs in GroupB and a single LED in GroupC (NOTE: GroupC only consists of a single current sink (D1C) under any configuration). Bits 53A and 62A in the general purpose register control where current sinks D53 and D62 are assigned. By writing a 1 to the 53A or 62A bits, D53 and D62 become assigned to the GroupA lighting region. Writing a 0 to these bits assigns D53 and D62 to the GroupB lighting region. With this added flexibility, the LM3535 is capable of supporting applications requiring 4, 5, or 6 LEDs for main display lighting, while still providing additional current sinks that can be used for a wide variety of lighting functions.

8.2.2.3 Maximum Output Current, Maximum LED Voltage, Minimum Input Voltage

The LM3535 can drive 8 LEDs at 25 mA each (GroupA, GroupB, GroupC) from an input voltage as low as 3.2 V, as long as the LEDs have a forward voltage of 3.6 V or less (room temperature).

The statement above is a simple example of the LED drive capability of the LM3535. The statement contains the key application parameters that are required to validate an LED-drive design using the LM3535: LED current (I_{LEDx}), number of active LEDs (N_x), LED forward voltage (V_{LED}), and minimum input voltage (V_{IN-MIN}).

Equation 5 and Equation 6 can be used to estimate the maximum output current capability of the LM3535:

$$I_{LED_MAX} = [(1.5 \times V_{IN}) - V_{LED} - (I_{ADDITIONAL} \times R_{OUT})] / [(N_x \times R_{OUT}) + k_{HRx}] \quad (5)$$

$$I_{LED_MAX} = [(1.5 \times V_{IN}) - V_{LED} - (I_{ADDITIONAL} \times 2.4 \Omega)] / [(N_x \times 2.4 \Omega) + k_{HRx}] \quad (6)$$

$I_{ADDITIONAL}$ is the additional current that could be delivered to the other LED groups.

R_{OUT} – Output resistance. This parameter models the internal losses of the charge pump that result in voltage droop at the pump output V_{OUT} . Since the magnitude of the voltage droop is proportional to the total output current of the charge pump, the loss parameter is modeled as a resistance. The output resistance of the LM3535 is typically 2.4 Ω ($V_{IN} = 3.6 \text{ V}$, $T_A = 25^\circ\text{C}$) — see Equation 7:

$$V_{OUT} = (1.5 \times V_{IN}) - [(N_A \times I_{LEDA} + N_B \times I_{LEDB} + N_C \times I_{LEDC}) \times R_{OUT}] \quad (7)$$

k_{HR} – Headroom constant. This parameter models the minimum voltage required to be present across the current sinks for them to regulate properly. This minimum voltage is proportional to the programmed LED current, so the constant has units of mV/mA. The typical k_{HR} of the LM3535 is 4mV/mA — see Equation 8:

$$(V_{OUT} - V_{LEDx}) > k_{HRx} \times I_{LEDx} \quad (8)$$

$$\text{Typical Headroom Constant Values } k_{HRA} = k_{HRB} = k_{HRC} = 4 \text{ mV/mA} \quad (9)$$

Equation 5 is obtained from combining Equation 7 (the R_{OUT} equation) with Equation 8 (the k_{HRx} equation) and solving for I_{LEDx} . Maximum LED current is highly dependent on minimum input voltage and LED forward voltage. Output current capability can be increased by raising the minimum input voltage of the application, or by selecting an LED with a lower forward voltage. Excessive power dissipation may also limit output current capability of an application.

8.2.2.3.1 Total Output Current Capability

The maximum output current that can be drawn from the LM3535 is 200 mA.

DRIVER TYPE	MAXIMUM Dxx CURRENT
DxA	25 mA per DxA pin
DxB	25 mA per DxB pin
D1C	25 mA

8.2.2.4 Parallel Connected and Unused Outputs

Connecting the outputs in parallel does not affect internal operation of the LM3535 and has no impact on the [Electrical Characteristics](#) and limits previously presented. The available diode output current, maximum diode voltage, and all other specifications provided in the [Electrical Characteristics](#) table apply to this parallel output configuration, just as they do to the standard LED application circuit.

All Dx current sinks utilize LED forward voltage sensing circuitry to optimize the charge-pump gain for maximum efficiency. Due to the nature of the sensing circuitry, TI recommends not leaving any of the Dx pins open when the current sinks are enabled (ENx bits are set to 1). Leaving Dx pins unconnected forces the charge-pump into 3/2x mode over the entire V_{IN} range negating any efficiency gain that could have been achieved by switching to 1x mode at higher input voltages.

If the D1B or D1C drivers are not going to be used, make sure that the ENB and ENC bits in the general purpose register are set to 0 to ensure optimal efficiency.

8.2.2.5 Power Efficiency

Efficiency of LED drivers is commonly taken to be the ratio of power consumed by the LEDs (P_{LED}) to the power drawn at the input of the part (P_{IN}). With a 3/2x – 1x charge pump, the input current is equal to the charge pump gain times the output current (total LED current). The efficiency of the LM3535 can be predicted as follow:

$$P_{LEDTOTAL} = (V_{LEDA} \times N_A \times I_{LEDA}) + (V_{LEDB} \times N_B \times I_{LEDB}) + (V_{LEDC} \times I_{LEDC}) \quad (10)$$

$$P_{IN} = V_{IN} \times I_{IN} \quad (11)$$

$$P_{IN} = V_{IN} \times (GAIN \times I_{LEDTOTAL} + I_Q) \quad (12)$$

$$E = (P_{LEDTOTAL} / P_{IN}) \quad (13)$$

The LED voltage is the main contributor to the charge-pump gain selection process. Use of low forward-voltage LEDs (3 V to 3.5 V) allows the LM3535 to stay in the gain of 1x for a higher percentage of the lithium-ion battery voltage range when compared to the use of higher forward voltage LEDs (3.5 V to 4 V). See [LED Forward Voltage Monitoring](#) for a more detailed description of the gain selection and transition process.

For an advanced analysis, TI recommends that power consumed by the circuit ($V_{IN} \times I_{IN}$) for a given load be evaluated rather than power efficiency.

8.2.2.6 Power Dissipation

The power dissipation (P_{DISS}) and junction temperature (T_J) can be approximated with the equations below. P_{IN} is the power generated by the 3/2x – 1x charge pump, P_{LED} is the power consumed by the LEDs, T_A is the ambient temperature, and $R_{\theta JA}$ is the junction-to-ambient thermal resistance for the DSBGA 20-bump package. V_{IN} is the input voltage to the LM3535, V_{LED} is the nominal LED forward voltage, N is the number of LEDs and I_{LED} is the programmed LED current.

$$P_{DISS} = P_{IN} - P_{LEDA} - P_{LEDB} - P_{LEDC} \quad (14)$$

$$P_{DISS} = (GAIN \times V_{IN} \times I_{GroupA} + I_{GroupB} + I_{GroupC}) - (V_{LEDA} \times N_A \times I_{LEDA}) - (V_{LEDB} \times N_B \times I_{LEDB}) - (V_{LEDC} \times I_{LEDC}) \quad (15)$$

$$T_J = T_A + (P_{DISS} \times R_{\theta JA}) \quad (16)$$

The junction temperature rating takes precedence over the ambient temperature rating. The LM3535 may be operated outside the ambient temperature rating, so long as the junction temperature of the device does not exceed the maximum operating rating of 110°C. The maximum ambient temperature rating must be derated in applications where high power dissipation and/or poor thermal resistance causes the junction temperature to exceed 110°C.

8.2.2.7 Thermal Protection

Internal thermal protection circuitry disables the LM3535 when the junction temperature exceeds 150°C (typical). This feature protects the device from being damaged by high die temperatures that might otherwise result from excessive power dissipation. The device recovers and operates normally when the junction temperature falls below 125°C (typical). It is important that the board layout provide good thermal conduction to keep the junction temperature within the specified operating ratings.

8.2.2.8 Capacitor Selection

The LM3535 requires 4 external capacitors for proper operation ($C_1 = C_2 = C_{IN} = C_{OUT} = 1 \mu\text{F}$). Surface-mount multi-layer ceramic capacitors are recommended. These capacitors are small, inexpensive and have very low equivalent series resistance (ESR < 20 mΩ typical). Tantalum capacitors, OS-CON capacitors, and aluminum electrolytic capacitors are not recommended for use with the LM3535 due to their high ESR, as compared to ceramic capacitors.

For most applications, ceramic capacitors with X7R or X5R temperature characteristic are preferred for use with the LM3535. These capacitors have tight capacitance tolerance (as good as ±10%) and hold their value over temperature (X7R: ±15% over –55°C to 125°C; X5R: ±15% over –55°C to 85°C).

Capacitors with Y5V or Z5U temperature characteristic are generally not recommended for use with the LM3535. Capacitors with these temperature characteristics typically have wide capacitance tolerance (+80%, –20%) and vary significantly over temperature (Y5V: +22%, –82% over –30°C to +85°C range; Z5U: +22%, –56% over +10°C to +85°C range). Under some conditions, a nominal 1μF Y5V or Z5U capacitor could have a capacitance of only 0.1 μF. Such detrimental deviation is likely to cause Y5V and Z5U capacitors to fail to meet the minimum capacitance requirements of the LM3535.

The recommended voltage rating for the capacitors is 10 V to account for DC bias capacitance losses.

8.2.3 Application Curves

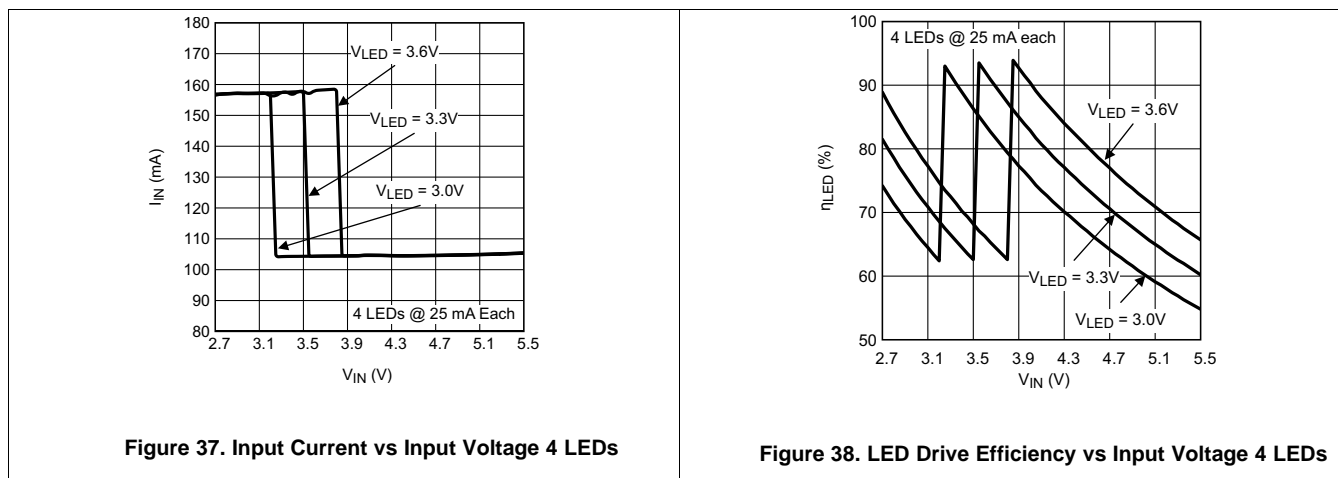

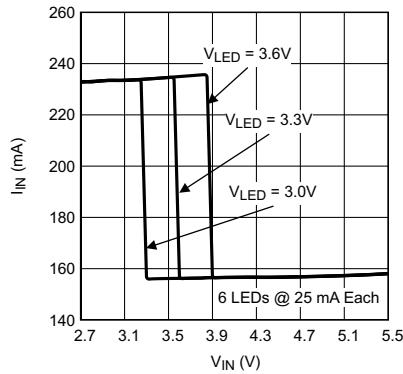

Figure 39. Input Current vs Input Voltage 6 LEDs

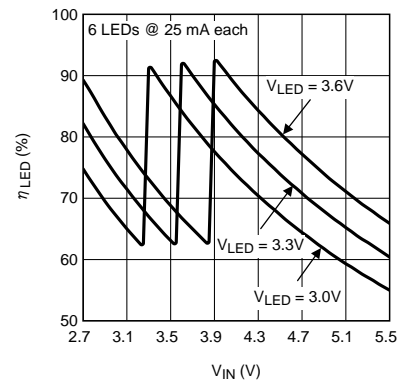

Figure 40. LED Drive Efficiency vs Input Voltage 6 LEDs

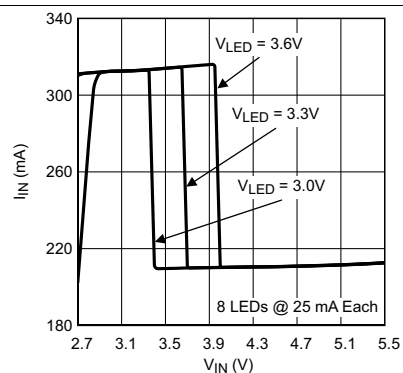

Figure 41. Input Current vs Input Voltage 8 LEDs

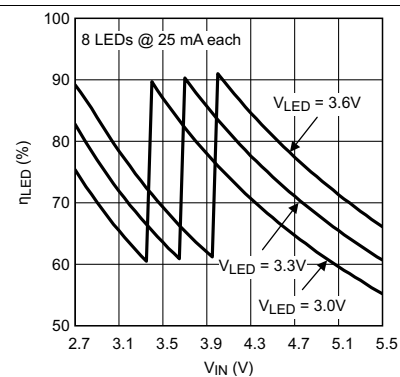

Figure 42. LED Drive Efficiency vs Input Voltage 8 LEDs

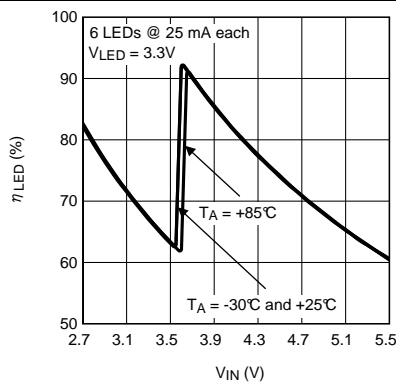

Figure 43. LED Drive Efficiency vs Input Voltage Tri-Temp 6 LEDs

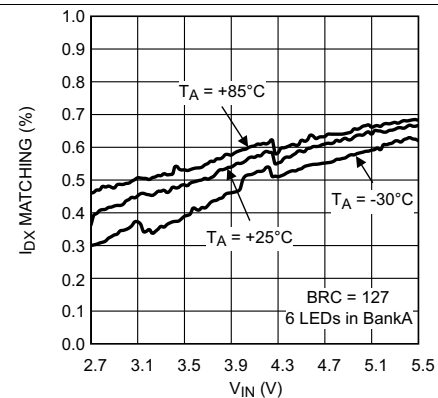

Figure 44. I_{LED} Matching vs Input Voltage 6 LEDs

9 Power Supply Recommendations

The LM3535 is designed to operate from an input voltage supply range between 2.7 V and 5.5 V. This input supply must be well regulated and capable to supply the required input current. If the input supply is located far from the LM3535 additional bulk capacitance may be required in addition to the ceramic bypass capacitors.

10 Layout

10.1 Layout Guidelines

Proper board layout helps to ensure optimal performance of the LM3535 circuit. The following guidelines are recommended:

- Place capacitors as close as possible to the LM3535, preferably on the same side of the board as the device.
- Use short, wide traces to connect the external capacitors to the LM3535 to minimize trace resistance and inductance.
- Use a low resistance connection between ground and the GND pins of the LM3535. Using wide traces and/or multiple vias to connect GND to a ground plane on the board is most advantageous.

10.2 Layout Example

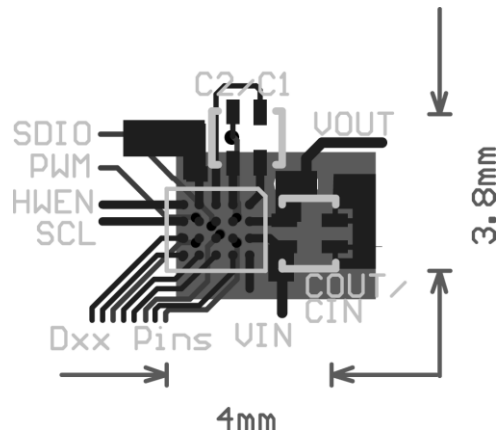

Figure 45. Minimum Layout

11 Device and Documentation Support

11.1 Receiving Notification of Documentation Updates

To receive notification of documentation updates, navigate to the device product folder on ti.com. In the upper right corner, click on *Alert me* to register and receive a weekly digest of any product information that has changed. For change details, review the revision history included in any revised document.

11.2 Community Resources

The following links connect to TI community resources. Linked contents are provided "AS IS" by the respective contributors. They do not constitute TI specifications and do not necessarily reflect TI's views; see TI's [Terms of Use](#).

TI E2E™ Online Community *TI's Engineer-to-Engineer (E2E) Community*. Created to foster collaboration among engineers. At e2e.ti.com, you can ask questions, share knowledge, explore ideas and help solve problems with fellow engineers.

Design Support *TI's Design Support* Quickly find helpful E2E forums along with design support tools and contact information for technical support.

11.3 Trademarks

E2E is a trademark of Texas Instruments.
All other trademarks are the property of their respective owners.

11.4 Electrostatic Discharge Caution



This integrated circuit can be damaged by ESD. Texas Instruments recommends that all integrated circuits be handled with appropriate precautions. Failure to observe proper handling and installation procedures can cause damage.

ESD damage can range from subtle performance degradation to complete device failure. Precision integrated circuits may be more susceptible to damage because very small parametric changes could cause the device not to meet its published specifications.

11.5 Glossary

SLYZ022 — *TI Glossary*.

This glossary lists and explains terms, acronyms, and definitions.

12 Mechanical, Packaging, and Orderable Information

The following pages include mechanical, packaging, and orderable information. This information is the most current data available for the designated devices. This data is subject to change without notice and revision of this document. For browser-based versions of this data sheet, refer to the left-hand navigation.

PACKAGING INFORMATION

Orderable Device	Status (1)	Package Type	Package Drawing	Pins	Package Qty	Eco Plan (2)	Lead finish/ Ball material (6)	MSL Peak Temp (3)	Op Temp (°C)	Device Marking (4/5)	Samples
LM3535TME/NOPB	ACTIVE	DSBGA	YFQ	20	250	RoHS & Green	SNAGCU	Level-1-260C-UNLIM	-30 to 85	3535	Samples
LM3535TMX/NOPB	ACTIVE	DSBGA	YFQ	20	3000	RoHS & Green	SNAGCU	Level-1-260C-UNLIM	-30 to 85	3535	Samples

(1) The marketing status values are defined as follows:

ACTIVE: Product device recommended for new designs.

LIFEBUY: TI has announced that the device will be discontinued, and a lifetime-buy period is in effect.

NRND: Not recommended for new designs. Device is in production to support existing customers, but TI does not recommend using this part in a new design.

PREVIEW: Device has been announced but is not in production. Samples may or may not be available.

OBSOLETE: TI has discontinued the production of the device.

(2) **RoHS:** TI defines "RoHS" to mean semiconductor products that are compliant with the current EU RoHS requirements for all 10 RoHS substances, including the requirement that RoHS substance do not exceed 0.1% by weight in homogeneous materials. Where designed to be soldered at high temperatures, "RoHS" products are suitable for use in specified lead-free processes. TI may reference these types of products as "Pb-Free".

RoHS Exempt: TI defines "RoHS Exempt" to mean products that contain lead but are compliant with EU RoHS pursuant to a specific EU RoHS exemption.

Green: TI defines "Green" to mean the content of Chlorine (Cl) and Bromine (Br) based flame retardants meet JS709B low halogen requirements of <=1000ppm threshold. Antimony trioxide based flame retardants must also meet the <=1000ppm threshold requirement.

(3) MSL, Peak Temp. - The Moisture Sensitivity Level rating according to the JEDEC industry standard classifications, and peak solder temperature.

(4) There may be additional marking, which relates to the logo, the lot trace code information, or the environmental category on the device.

(5) Multiple Device Markings will be inside parentheses. Only one Device Marking contained in parentheses and separated by a "~" will appear on a device. If a line is indented then it is a continuation of the previous line and the two combined represent the entire Device Marking for that device.

(6) Lead finish/Ball material - Orderable Devices may have multiple material finish options. Finish options are separated by a vertical ruled line. Lead finish/Ball material values may wrap to two lines if the finish value exceeds the maximum column width.

Important Information and Disclaimer:The information provided on this page represents TI's knowledge and belief as of the date that it is provided. TI bases its knowledge and belief on information provided by third parties, and makes no representation or warranty as to the accuracy of such information. Efforts are underway to better integrate information from third parties. TI has taken and continues to take reasonable steps to provide representative and accurate information but may not have conducted destructive testing or chemical analysis on incoming materials and chemicals. TI and TI suppliers consider certain information to be proprietary, and thus CAS numbers and other limited information may not be available for release.

In no event shall TI's liability arising out of such information exceed the total purchase price of the TI part(s) at issue in this document sold by TI to Customer on an annual basis.

TAPE AND REEL INFORMATION

QUADRANT ASSIGNMENTS FOR PIN 1 ORIENTATION IN TAPE

*All dimensions are nominal

Device	Package Type	Package Drawing	Pins	SPQ	Reel Diameter (mm)	Reel Width W1 (mm)	A0 (mm)	B0 (mm)	K0 (mm)	P1 (mm)	W (mm)	Pin1 Quadrant
LM3535TME/NOPB	DSBGA	YFQ	20	250	178.0	8.4	1.89	2.2	0.76	4.0	8.0	Q1
LM3535TMX/NOPB	DSBGA	YFQ	20	3000	178.0	8.4	1.89	2.2	0.76	4.0	8.0	Q1

TAPE AND REEL BOX DIMENSIONS

*All dimensions are nominal

Device	Package Type	Package Drawing	Pins	SPQ	Length (mm)	Width (mm)	Height (mm)
LM3535TME/NOPB	DSBGA	YFQ	20	250	208.0	191.0	35.0
LM3535TMX/NOPB	DSBGA	YFQ	20	3000	208.0	191.0	35.0

YFQ0020

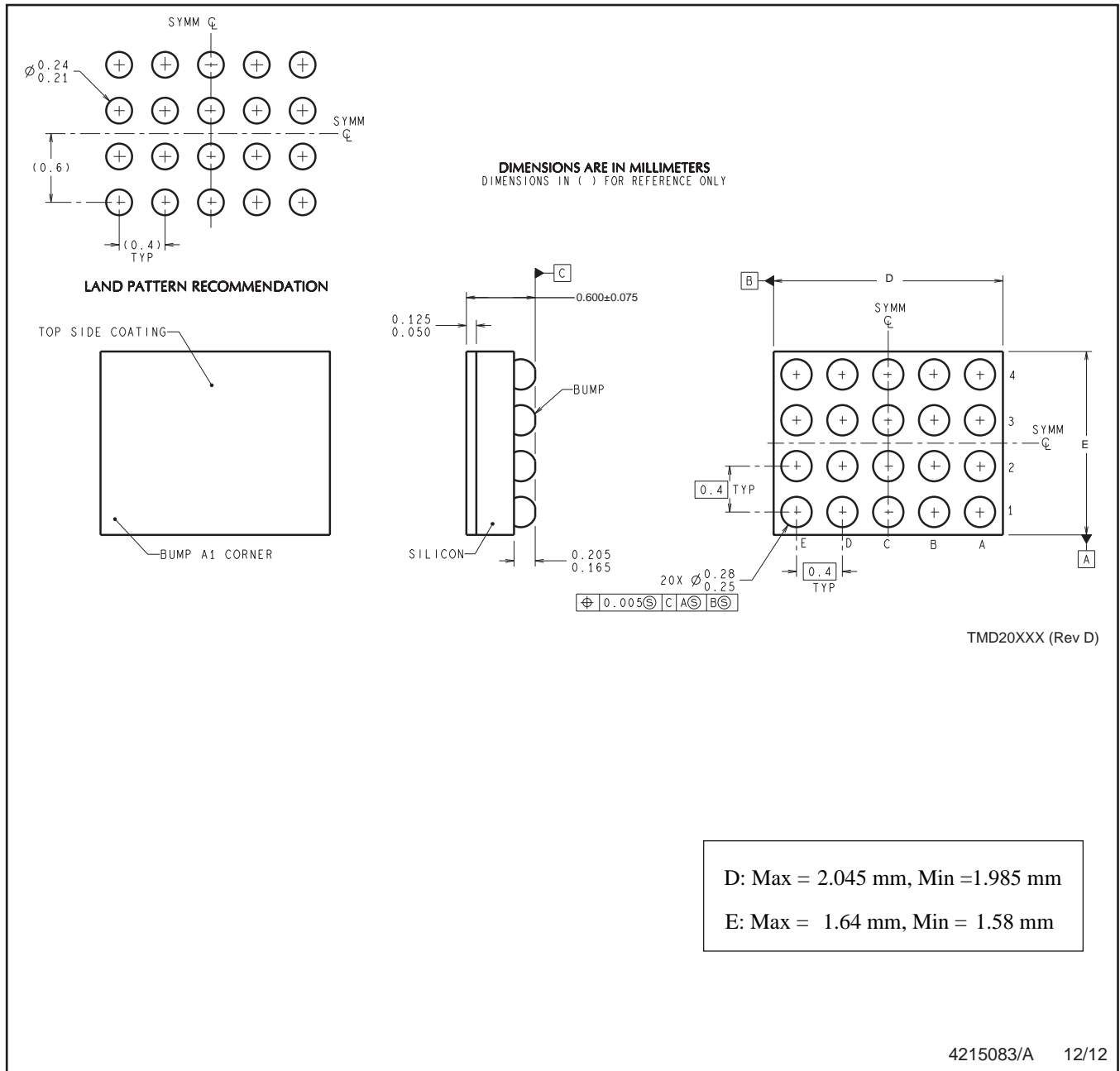

NOTES: A. All linear dimensions are in millimeters. Dimensioning and tolerancing per ASME Y14.5M-1994.
B. This drawing is subject to change without notice.

IMPORTANT NOTICE AND DISCLAIMER

TI PROVIDES TECHNICAL AND RELIABILITY DATA (INCLUDING DATA SHEETS), DESIGN RESOURCES (INCLUDING REFERENCE DESIGNS), APPLICATION OR OTHER DESIGN ADVICE, WEB TOOLS, SAFETY INFORMATION, AND OTHER RESOURCES "AS IS" AND WITH ALL FAULTS, AND DISCLAIMS ALL WARRANTIES, EXPRESS AND IMPLIED, INCLUDING WITHOUT LIMITATION ANY IMPLIED WARRANTIES OF MERCHANTABILITY, FITNESS FOR A PARTICULAR PURPOSE OR NON-INFRINGEMENT OF THIRD PARTY INTELLECTUAL PROPERTY RIGHTS.

These resources are intended for skilled developers designing with TI products. You are solely responsible for (1) selecting the appropriate TI products for your application, (2) designing, validating and testing your application, and (3) ensuring your application meets applicable standards, and any other safety, security, regulatory or other requirements.

These resources are subject to change without notice. TI grants you permission to use these resources only for development of an application that uses the TI products described in the resource. Other reproduction and display of these resources is prohibited. No license is granted to any other TI intellectual property right or to any third party intellectual property right. TI disclaims responsibility for, and you will fully indemnify TI and its representatives against, any claims, damages, costs, losses, and liabilities arising out of your use of these resources.

TI's products are provided subject to [TI's Terms of Sale](#) or other applicable terms available either on ti.com or provided in conjunction with such TI products. TI's provision of these resources does not expand or otherwise alter TI's applicable warranties or warranty disclaimers for TI products.

TI objects to and rejects any additional or different terms you may have proposed.

Mailing Address: Texas Instruments, Post Office Box 655303, Dallas, Texas 75265
Copyright © 2022, Texas Instruments Incorporated