

NOTE:

MATERIAL	
HOUSING:	PA66 UL94V-0, BLACK
CONTACT:	BRASS
NUT:	BRASS
O-RING:	EPDM, BLACK
FINISH	
CONTACT:	10u" GOLD PLATED
NUT:	NICKEL
ELECTRICAL	
RATED CURRENT:	4A
RATED VOLTAGE:	250V
INSULATOR RESISTANCE:	100 MOhms MIN.
CONTACT RESISTANCE:	10 mOhms MAX.
WATER PROOF:	IP67
ENVIRONMENT	
OPERATION TEMPERATURE:	-40°C TO +85°C
MAX WIRE AWG:	22 AWG

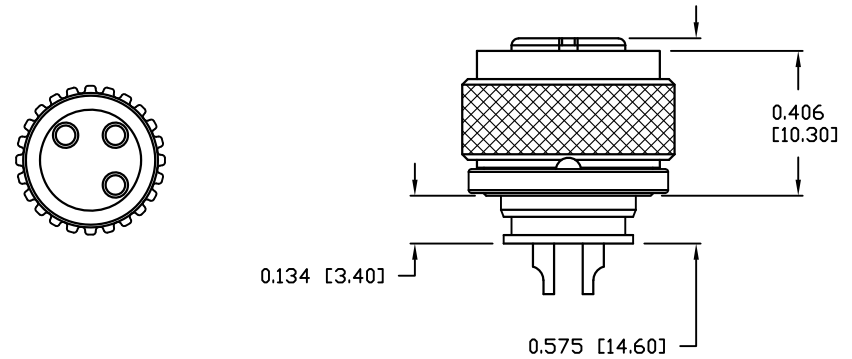
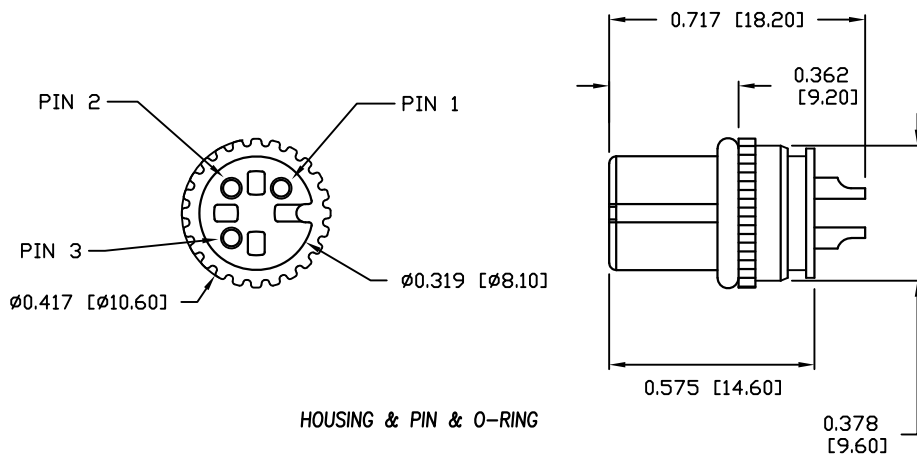

RoHS COMPLIANT

UNITS = inch [mm]

DO NOT SCALE FROM DRAWING



THESE DRAWINGS AND SPECIFICATIONS ARE THE PROPERTY OF NorComp AND SHALL NOT BE REPRODUCED, COPIED OR USED AS THE BASIS FOR THE MANUFACTURE OR SALE OF APPARATUS WITHOUT WRITTEN PERMISSION.

DRAWN:
M. SIGMON

DATE:
08/04/2016

NorComp

SCALE: NTS	SHEET 1	OF 1	REV 3
---------------	------------	---------	----------

DWG NO. 858VA03-203RLU4