

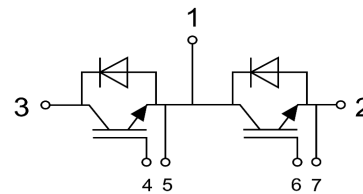
$V_{CES} = 1200V$
$I_C = 50A$ at $T_C = 80^\circ C$
$V_{CE(ON)} = 1.70V$ at $I_C = 50A$

**IGBT Half-Bridge
POWIR 34™ Package**



Applications:

- Industrial Motor Drive
- Uninterruptible Power Supply
- Welding and Cutting Machine
- Switched Mode Power Supply
- Induction Heating
- AC Inverter Drive



Features	Benefits
Low $V_{CE(ON)}$ and Switching Losses	High Efficiency in a Wide Range of Applications
100% RBSOA Tested	Rugged Transient Performance
POWIR 34™ Package	Industry Standard
Lead Free	RoHS Compliant, Environmental Friendly

Base Part Number	Package Type	Standard Pack	Quantity	Orderable Part Number
IRG7U50HF12A	POWIR 34™	Box	80	IRG7U50HF12A

Absolute Maximum Ratings of IGBT

V_{CES}	Collector to Emitter Voltage	1200	V
V_{GES}	Continuous Gate to Emitter Voltage	±20	V
I_C	Continuous Collector Current	$T_C = 80^\circ C$	50 A
		$T_C = 25^\circ C$	100 A
I_{CM}	Pulse Collector Current	$T_J = 175^\circ C$	100 A
P_D	Maximum Power Dissipation (IGBT)	$T_C = 25^\circ C, T_J = 175^\circ C$	310 W
T_J	Maximum IGBT Junction Temperature	175	°C
T_{JOP}	Maximum Operating Junction Temperature Range	-40 to +150	°C
T_{stg}	Storage Temperature	-40 to +125	°C

Electrical Characteristics of IGBT at $T_J = 25^\circ\text{C}$ (Unless Otherwise Specified)

Parameter		Min.	Typ.	Max.	Unit	Test Conditions	
$V_{(BR)CES}$	Collector to Emitter Breakdown Voltage	1200			V	$V_{GE} = 0V, I_C = 1mA$	
$V_{GE(th)}$	Gate Threshold Voltage	3.4	4.2	4.9	V	$I_C = 2mA, V_{CE} = V_{GE}$	
$V_{CE(ON)}$	Collector to Emitter Saturation Voltage		1.70	2.00	V	$T_J = 25^\circ\text{C}$	$I_C = 50A, V_{GE} = 15V$
			1.90		V	$T_J = 125^\circ\text{C}$	
I_{CES}	Collector to Emitter Leakage Current			1	mA	$V_{GE} = 0V, V_{CE} = V_{CES}$	
I_{GES}	Gate to Emitter Leakage Current			400	nA	$V_{GE} = \pm 20V, V_{CE} = 0V$	

Switching Characteristics of IGBT

Parameter		Min.	Typ.	Max.	Unit	Test Conditions	
$t_{d(on)}$	Turn-on Delay Time		495		ns	$T_J = 25^\circ\text{C}$	$V_{CC} = 600V, I_C = 50A, R_G = 40\Omega, V_{GE} = \pm 15V, \text{Inductive Load}$
			495			$T_J = 125^\circ\text{C}$	
t_r	Rise Time		90		ns	$T_J = 25^\circ\text{C}$	
			85			$T_J = 125^\circ\text{C}$	
$t_{d(off)}$	Turn-off Delay Time		475		ns	$T_J = 25^\circ\text{C}$	
			500			$T_J = 125^\circ\text{C}$	
t_f	Fall Time		170		ns	$T_J = 25^\circ\text{C}$	
			260			$T_J = 125^\circ\text{C}$	
E_{on}	Turn-on Switching Loss		4.9		mJ	$T_J = 25^\circ\text{C}$	
			5.8			$T_J = 125^\circ\text{C}$	
E_{off}	Turn-off Switching Loss		1.7		mJ	$T_J = 25^\circ\text{C}$	
			2.5			$T_J = 125^\circ\text{C}$	
Q_g	Total Gate Charge		450		nC	$T_J = 25^\circ\text{C}$	
C_{ies}	Input Capacitance		6.0		nF	$V_{CE} = 25V, V_{GE} = 0V, f = 1MHz, T_J = 25^\circ\text{C}$	
C_{oes}	Output Capacitance		0.19				
C_{res}	Reverse Transfer Capacitance		0.13				
RBSOA	Reverse Bias Safe Operating Area	Trapezoid				$I_C = 100A, V_{CC} = 960V, V_P = 1200V, R_G = 15\Omega, V_{GE} = +15V \text{ to } 0V, T_J = 150^\circ\text{C}$	

Absolute Maximum Ratings of Freewheeling Diode

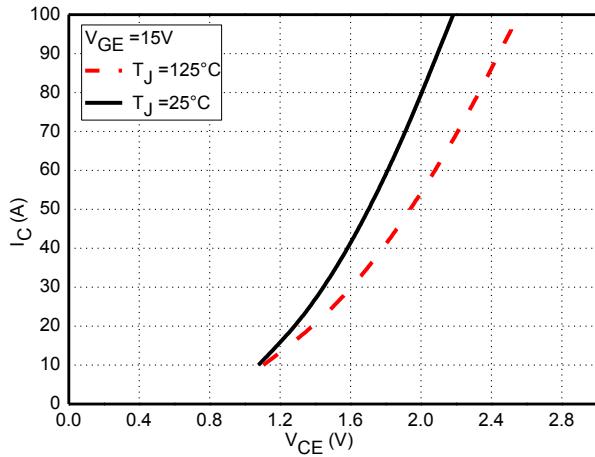
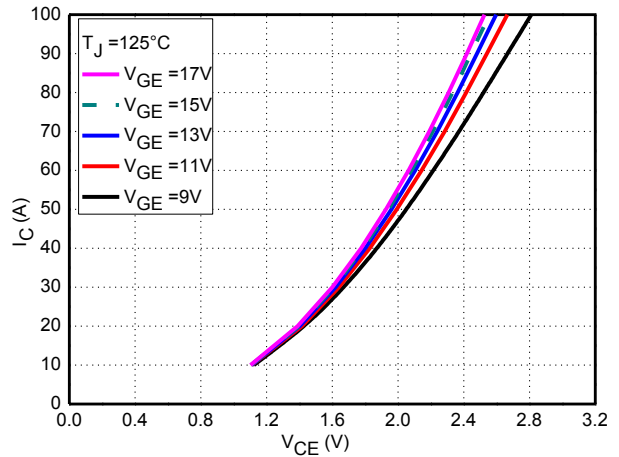
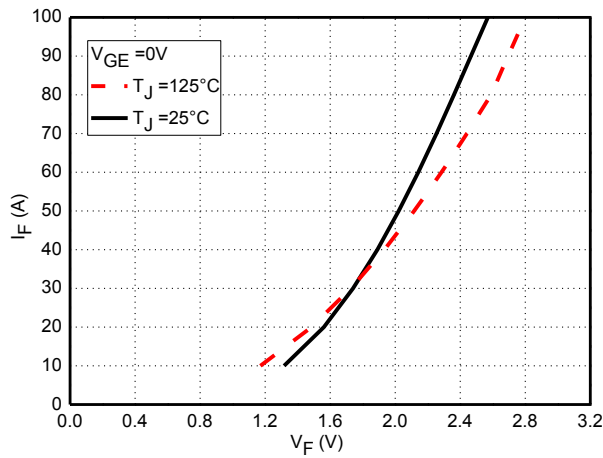
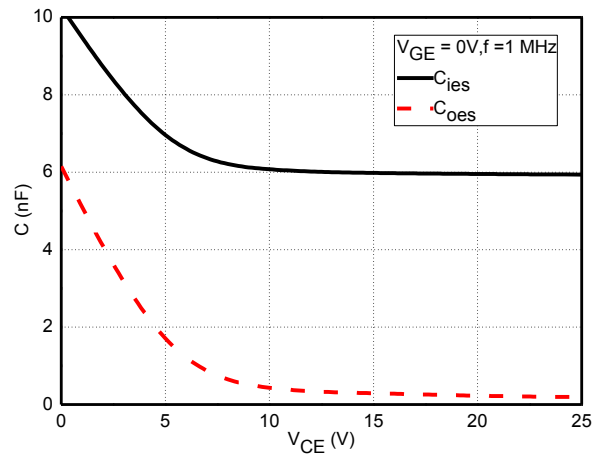
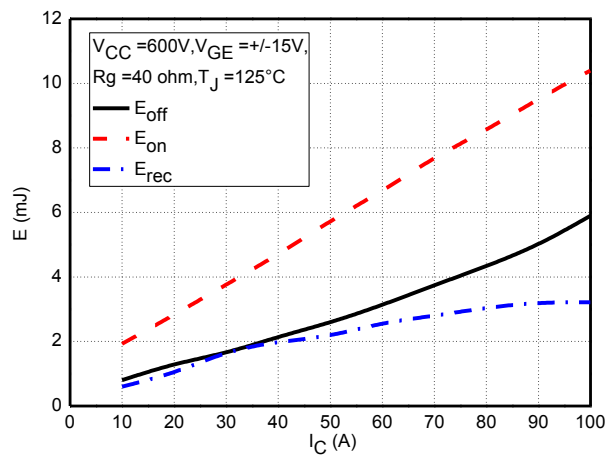
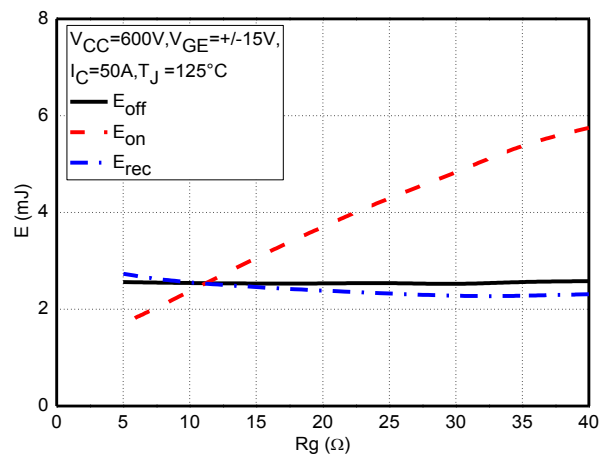
V_{RRM}	Repetitive Peak Reverse Voltage	1200	V
I_F	Diode Continuous Forward Current, $T_C = 25^\circ\text{C}$	100	A
	Diode Continuous Forward Current, $T_C = 80^\circ\text{C}$	50	
I_{FM}	Pulse Diode Current	100	A

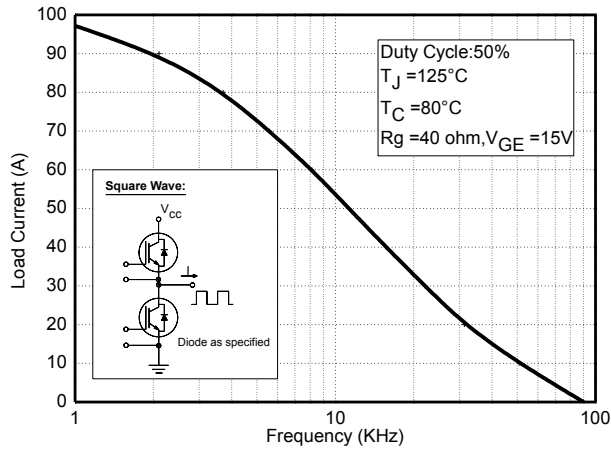
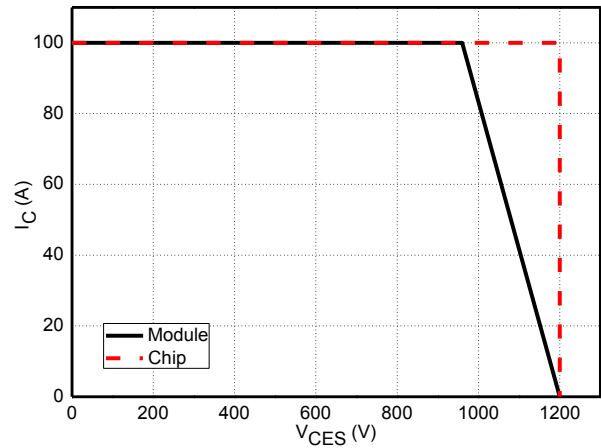
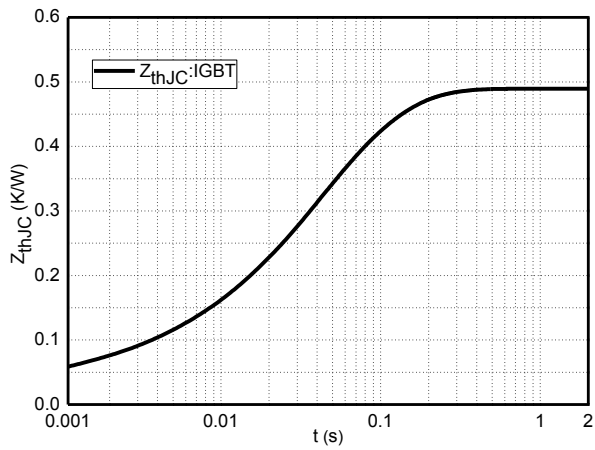
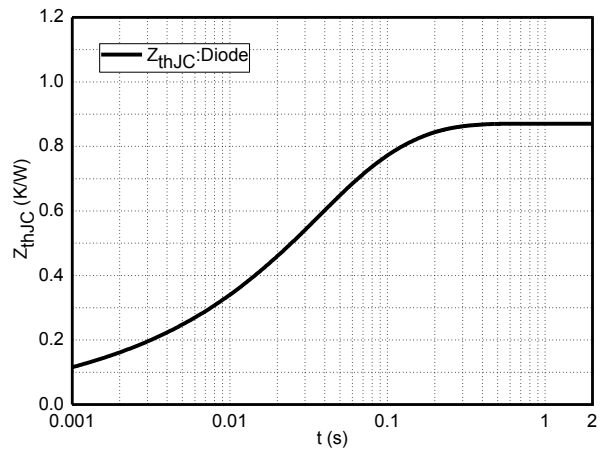
Electrical and Switching Characteristics of Freewheeling Diode

Parameter		Typ.	Max.	Unit	Test Conditions	
V_F	Forward Voltage	2.00	2.70	V	$T_J = 25^\circ\text{C}$	$I_F = 50\text{A}$, $V_{GE} = 0\text{V}$
		2.20			$T_J = 125^\circ\text{C}$	
I_{rr}	Peak Reverse Recovery Current	25		A	$T_J = 25^\circ\text{C}$	$I_F = 50\text{A}$, $di/dt = 660\text{A}/\mu\text{s}$, $V_{rr} = 600\text{V}$, $V_{GE} = -15\text{V}$
		30			$T_J = 125^\circ\text{C}$	
Q_{rr}	Reverse Recovery Charge	3.6		μC	$T_J = 25^\circ\text{C}$	
		5.9			$T_J = 125^\circ\text{C}$	
E_{rec}	Reverse Recovery Energy	1.00		mJ	$T_J = 25^\circ\text{C}$	
		2.15			$T_J = 125^\circ\text{C}$	

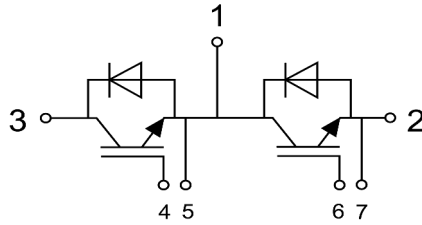
Module Characteristics

Parameter		Min.	Typ.	Max.	Unit
V_{iso}	Isolation Voltage (All Terminals Shorted), $f = 50\text{Hz}$, 1minute			2500	V
$R_{\theta JC}$	Junction-to-Case (IGBT)		0.48		$^\circ\text{C}/\text{W}$
$R_{\theta JC}$	Junction-to-Case (Diode)		0.87		$^\circ\text{C}/\text{W}$
$R_{\theta CS}$	Case-To-Sink (Conductive Grease Applied)		0.1		$^\circ\text{C}/\text{W}$
M	Power Terminals Screw: M5	3.0		5.0	N·m
M	Mounting Screw: M6	4.0		6.0	N·m
G	Weight		165		g

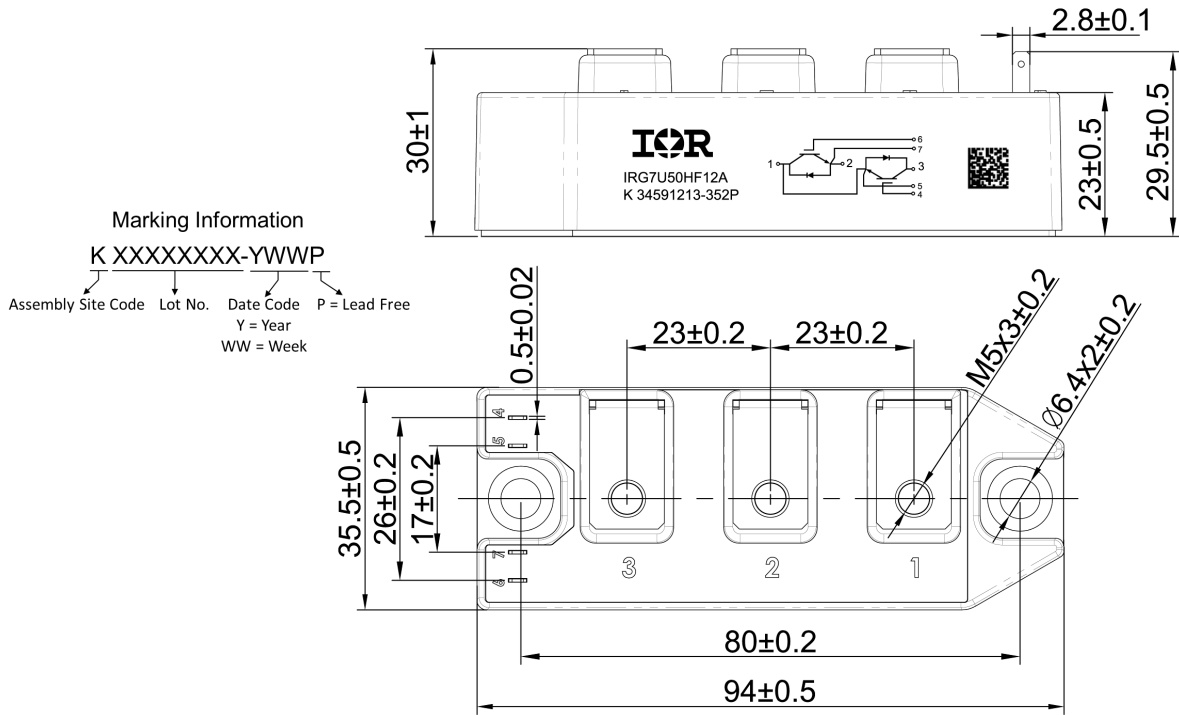

Fig.1 Typical IGBT Saturation Characteristics

Fig.2 Typical IGBT Output Characteristics

Fig.3 Typical Diode Forward Characteristics

Fig. 4 Typical Capacitance Characteristics

Fig.5 Typical Switching Loss vs. Collector Current

Fig.6 Typical Switching Loss vs. Gate Resistance


Fig.7 Typical Load Current vs. Frequency

Fig.8 Reverse Bias Safe Operation Area (RBSOA)

Fig.9 Typical Transient Thermal Impedance (IGBT)

Fig.10 Typical Transient Thermal Impedance (Diode)

Internal Circuit:



Package Outline (Unit: mm):



Qualification Information†

Qualification Level	Industrial
Moisture Sensitivity Level	Not Applicable
RoHS Compliant	Yes

† Qualification standards can be found at International Rectifier’s web site: <http://www.irf.com/product-info/reliability/>