



# American Opto Plus LED Corp.

## CTD591E-W/W

15.0 x 15.0 x 11.0 mm Touch LED Red Display

### PACKAGE DIMENSION

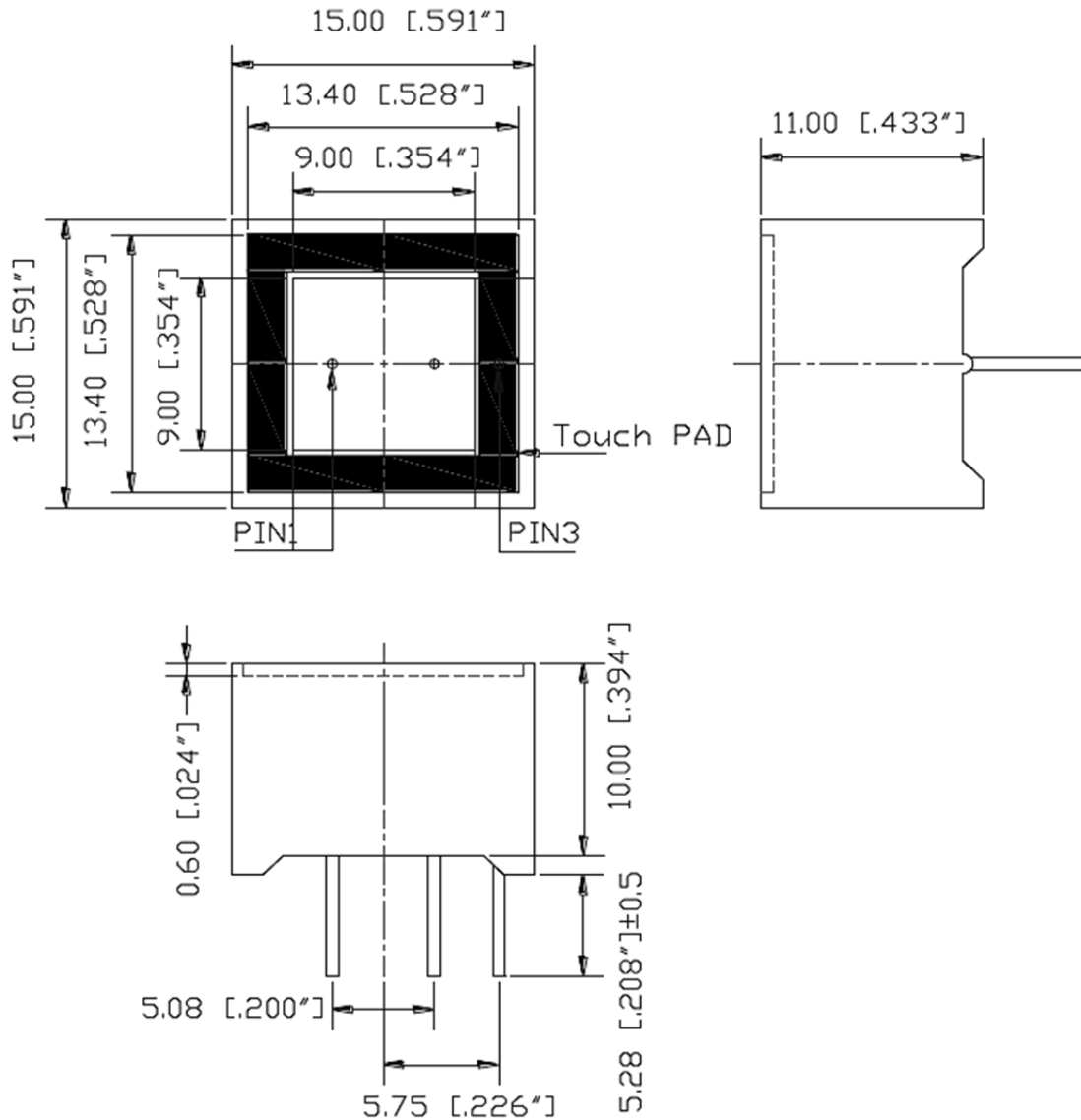

#### Notes:

1. All pins are  $\Phi 0.60[0.24]$ , dimensions in millimeter.
2. Tolerances are  $\pm 0.25[0.01]$  unless otherwise noted.

Chip Material	Color	
	Emitter	Face/Segment
AlGaInP	Red	White/ White



American Opto Plus LED Corp.

CTD591E-W/W

15.0 x 15.0 x 11.0 mm Touch LED Red Display

PIN POSITION & INTERNAL CIRCUIT DIAGRAM

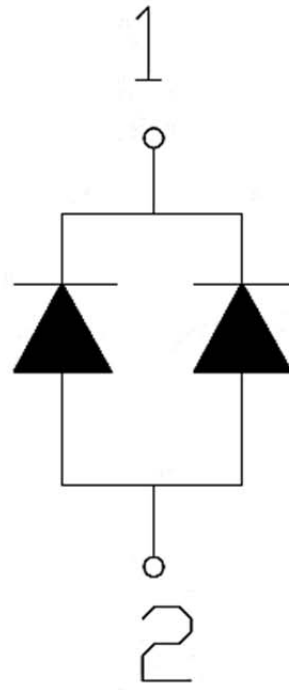
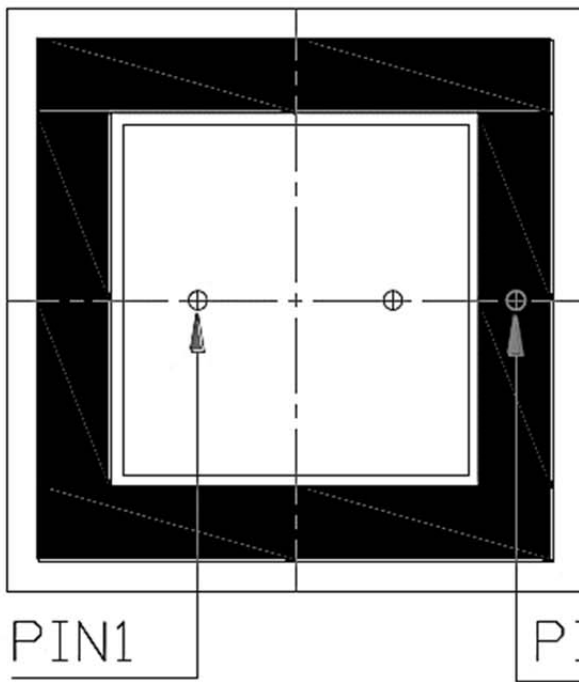

Touch PAD





# American Opto Plus LED Corp.

## CTD591E-W/W

15.0 x 15.0 x 11.0 mm Touch LED Red Display

### ABSOLUTE MAXIMUM RATINGS

(Ta=25°C)

Parameter	Symbol	Value	Unit
Power Dissipation Per Dice	$P_D$	70	mW
Derating Liner from 25°C Per Dice	--	0.33	mA/°C
Continuous Forward Current Per Dice	$I_F$	25	mA
Peak Current Per Dice (duty cycle 1/10, 1KHz)	$I_{FP}$	90	mA
Reverse Voltage Per Dice	$V_R$	5	V
Operating Temperature Range	$T_{OPR}$	-35~+85	°C
Storage Temperature Range	$T_{STG}$	-35~+85	°C

### OPTICAL-ELECTRICAL CHARACTERISTICS

(Ta=25°C)

Parameter	Symbol	Test Condition	Value			Unit
			Min	Typ	Max	
Forward Voltage	$V_F$	$I_F=20mA$	--	2.0	2.8	V
Luminous Intensity	$I_V$		44	78	--	mcd
Peak Emission Wavelength	$\lambda_P$		--	632	--	nm
Dominant Wavelength	$\lambda_D$		--	625	--	nm
Spectrum Radiation Bandwidth	$\Delta\lambda$		--	20	--	nm
Luminous Intensity Matching Ratio	$I_V-m$	$I_F=10mA$	--	--	2:1	--
Reverse Current	$I_R$	$V_R=5V$	--	--	100	$\mu A$

Forward voltage tolerance:  $\pm 0.1V$

Luminous intensity tolerance:  $\pm 20\%$



# American Opto Plus LED Corp.

## CTD591E-W/W

15.0 x 15.0 x 11.0 mm Touch LED Red Display

### LUMINOUS INTENSITY BIN GRADE

( $I_F=20\text{mA}$ )

N	P	Q
44.096	70.555	112.889
I	I	I
70.554	112.888	180.622



# American Opto Plus LED Corp.

## CTD591E-W/W

15.0 x 15.0 x 11.0 mm Touch LED Red Display

### OPTICAL CHARACTERISTIC CURVES

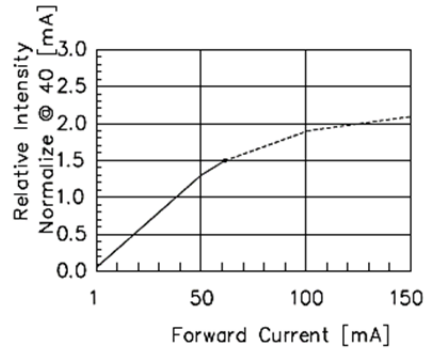
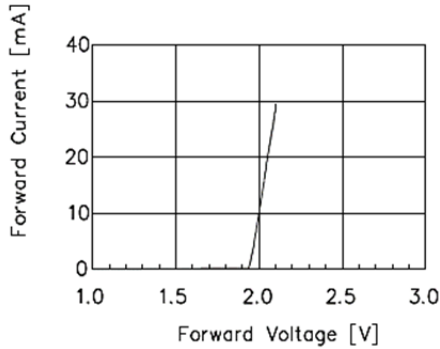

Fig 1. Forward Current vs. Forward Voltage(One chip) Fig 2. Relative Intensity vs. Forward Current

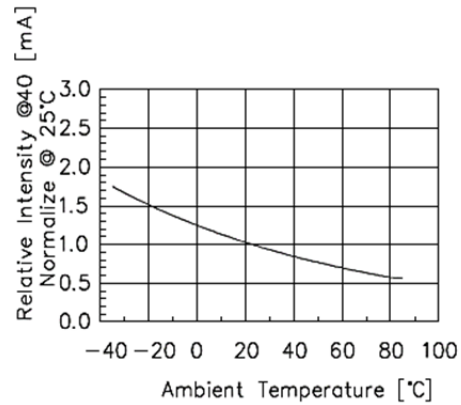
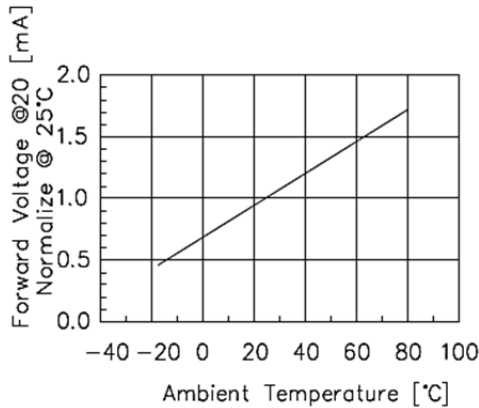

Fig 3. Forward Voltage vs. Temperature(One chip) Fig 4. Relative Intensity vs. Temperature

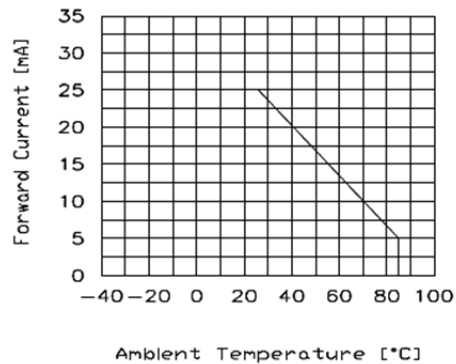
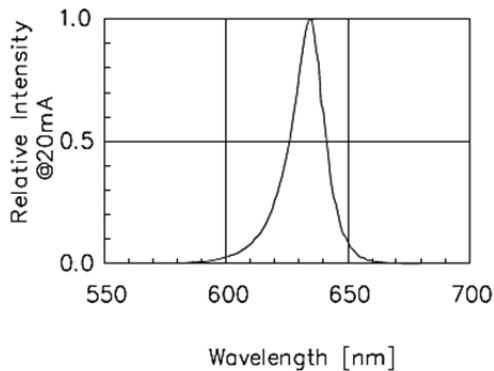

Fig 5. Relative Intensity vs. Wavelength(One chip) Fig 6. Maximum allowable DC current per segment vs. A function of ambient temperature(One chip)



# American Opto Plus LED Corp.

## CTD591E-W/W

15.0 x 15.0 x 11.0 mm Touch LED Red Display

### SOLDERING CONDITIONS

#### 1. Wave Soldering Profile

Distance: 1.6mm min (From Seating Plane)

Item	Condition		Note
Preheat	Temperature T1	80 – 120 °C	PWB Temperature (Soldering Side Surface)
	Time t1	60 – 180sec	
Solder Dip	Temperature T2	230 – 260°C	Bath Temperature
	Time t2	2 – 4 sec	Solder Tank Passage Time

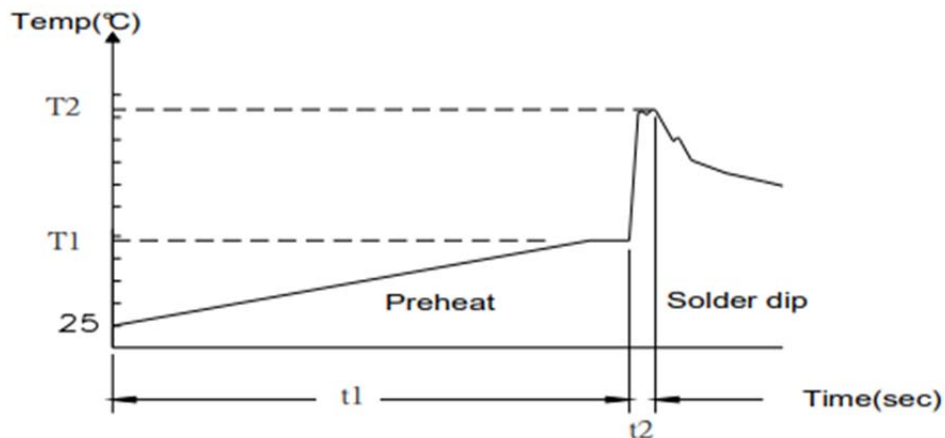

#### 2. Hand Soldering (Iron Condition)

Soldering Iron: 30W Max

Temperature 350°C Max

Soldering Time: 3 Seconds Max (One Time)

Distance: 1.6mm min (From Seating Plane)



# American Opto Plus LED Corp.

## CTD591E-W/W

15.0 x 15.0 x 11.0 mm Touch LED Red Display

### PACKAGE SPECIFICATION

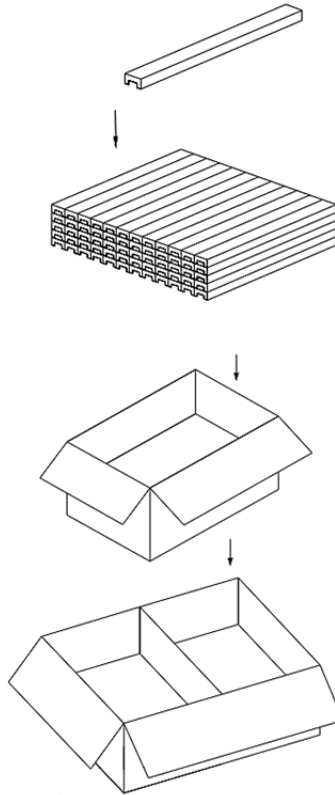

Package	Size	Unit	Amount	Unit	Amount	Unit	Note
TUBE	L300*W190*H20	mm	1	TUBE	10	Pcs	--
Inner Box	L305*W205*H240	mm	187	TUBE	1870	Pcs	17*11=187
Outer Box	L430*W330*H270	mm	2	Inner Box	3740	Pcs	--

### STORAGE METHOD

1. Product cannot be placed on the location of direct sunlight.
2. Product storage environment: Temp. -35°C~85°C, RH 45%~85%.
3. After unpacking the product be use within 1 year.
4. After unpacking, do not take anything up in order to avoid PIN shifting.