

MHS 5/02 H T3 B T

Weidmüller Interface GmbH & Co. KG

Klingenbergstraße 26

D-32758 Detmold

Germany

www.weidmueller.com

Product image

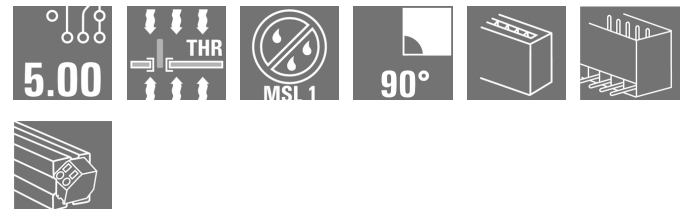

Configurable connector portfolio with fast and safe SNAP IN connection technology. The modular slice concept allows different hybrid combinations out of signal, data and power in one. The future-proof system is suitable for the highest requirements of the digital and connected world.

General ordering data

Order No.	274140000
Type	MHS 5/02 H T3 B T
GTIN (EAN)	4064675055389
Qty.	48 pc(s).
Product data	IEC: 400 V / 26.8 A UL: 300 V / 18.5 A
Packaging	Tube

Creation date December 21, 2020 4:38:28 PM CET

Catalogue status 08.12.2020 / We reserve the right to make technical changes.

MHS 5/02 H T3 B T

Weidmüller Interface GmbH & Co. KG

Klingenbergstraße 26

D-32758 Detmold

Germany

www.weidmueller.com

Technical data

Dimensions and weights

Depth	14 mm	Depth (inches)	0.551 inch
Height	15.1 mm	Height (inches)	0.594 inch
Height of lowest version	11.9 mm	Net weight	1.801 g
Weight	1.78 g	Width	11.4 mm
Width (inches)	0.449 inch		

System specifications

Type of connection	Board connection	Mounting onto the PCB	THT/THR solder connection
Pitch in mm (P)	5 mm	Pitch in inches (P)	0.197 inch
Outgoing elbow	90°	Number of poles	2
Number of solder pins per pole	1	Solder pin length (l)	3.2 mm
Solder pin dimensions	1.0 x 1.0 mm	Solder eyelet hole diameter (D)	1.4 mm
Solder eyelet hole diameter tolerance (D)+ 0,1 mm		Outside diameter of solder pad	2.3 mm
Template aperture diameter	2.1 mm	Number of rows	1
Pin series quantity	1	Touch-safe protection acc. to DIN VDE 57 106	Touch-safe above the printed circuit board
Touch-safe protection acc. to DIN VDE 0470	IP 20	Volume resistance	≤5 mΩ
Plugging force/pole, max.	8.5 N	Pulling force/pole, max.	8.5 N

Material data

Insulating material	PA 9T	Colour	black
Colour chart (similar)	RAL 9011	Insulating material group	I
Comparative Tracking Index (CTI)	≥ 600	Moisture Level (MSL)	1
UL 94 flammability rating	V-0	Contact base material	CuMg
Contact material	CuMg	Contact surface	tinned
Tinning type	matt	Layer structure of solder connection	1...3 μm Ni / 2...4 μm Sn matt
Layer structure of plug contact	1...3 μm Ni / 2...4 μm Sn matt	Storage temperature, min.	-25 °C
Storage temperature, max.	55 °C	Operating temperature, min.	-50 °C
Operating temperature, max.	100 °C		

Rated data acc. to IEC

tested acc. to standard	IEC 60664-1, IEC 61984	Rated current, min. number of poles (Tu=20°C)	26.8 A
Rated current, max. number of poles (Tu=20°C)	19.7 A	Rated current, min. number of poles (Tu=40°C)	23.1 A
Rated current, max. number of poles (Tu=40°C)	16.9 A	Rated voltage for surge voltage class / pollution degree II/2	400 V
Rated voltage for surge voltage class / pollution degree III/2	320 V	Rated voltage for surge voltage class / pollution degree III/3	250 V
Rated impulse voltage for surge voltage class/ pollution degree II/2	4 kV	Rated impulse voltage for surge voltage class/ pollution degree III/2	4 kV
Rated impulse voltage for surge voltage class/ contamination degree III/3	4 kV		

Data sheet

MHS 5/02 H T3 B T

Weidmüller Interface GmbH & Co. KG
 Klingenbergstraße 26
 D-32758 Detmold
 Germany

www.weidmueller.com

Technical data

Rated data acc. to UL 1059

Institute (cURus)



Certificate No. (cURus)

E60693

Rated voltage (Use group B / UL 1059) 300 V

Rated voltage (Use group D / UL 1059) 300 V

Rated current (Use group B / UL 1059) 18.5 A

Rated current (Use group D / UL 1059) 10 A

Reference to approval values Specifications are maximum values, details - see approval certificate.

Classifications

ETIM 6.0 EC002637

ETIM 7.0 EC002637

ECLASS 9.0 27-44-04-02

ECLASS 9.1 27-44-04-02

ECLASS 10.0 27-44-04-02

ECLASS 11.0 27-46-02-01

Important note

IPC conformity

Conformity: The products are developed, manufactured and delivered according international recognized standards and norms and comply with the assured properties in the data sheet resp. fulfill decorative properties in accordance with IPC-A-610 "Class 2". Further claims on the products can be evaluated on request.

Notes

- Rated current related to rated cross-section & min. No. of poles.
- P on drawing = pitch
- Rated data refer only to the component itself. Clearance and creepage distances to other components are to be designed in accordance with the relevant application standards.
- Diameter of solder eyelet D = 1.4+0.1mm

Approvals

Approvals



UL File Number Search E60693

Downloads

Engineering Data [STEP](#)

MHS 5/02 H T3 B T

Weidmüller Interface GmbH & Co. KG
 Klingenbergstraße 26
 D-32758 Detmold
 Germany

www.weidmueller.com

Drawings

Product image

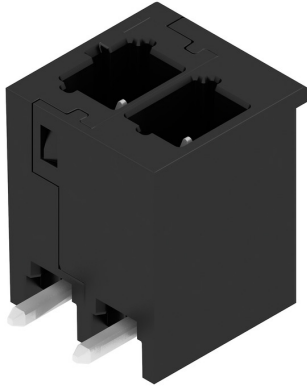

Dimensional drawing

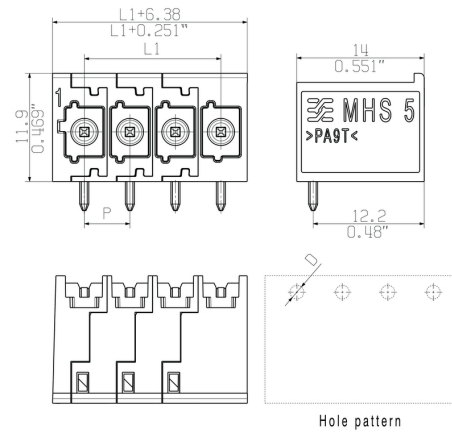

MHS 5/02 H T3 B T

Weidmüller Interface GmbH & Co. KG
 Klingenbergstraße 26
 D-32758 Detmold
 Germany

www.weidmueller.com

Mating connector (fully pluggable)

Without middle-flange

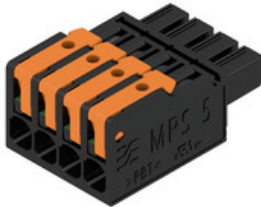

General ordering data

General ordering data		Product data	Packaging
Type	MPS 5/02 S TN B B	IEC: 400 V / 26.8 A / 0.5 - 2.5 mm ²	Box
Order No.	2741560000	UL: 300 V / 18.5 A / AWG 20 - AWG 12/7, AWG12/9	
GTIN (EAN)	4064675054993		
Qty.	168 pc(s).		

With middle-flange



General ordering data

General ordering data		Product data	Packaging
Type	MPS 5/02 S F1 TN B B	IEC: 400 V / 26.8 A / 0.5 - 2.5 mm ²	Box
Order No.	2741670000	UL: 300 V / 18.5 A / AWG 20 - AWG 12/7, AWG12/9	
GTIN (EAN)	4064675055198		
Qty.	168 pc(s).		

Allgemeingültige Kundenzeichnung, aktueller Stand nur auf Anfrage
 General customer drawing, topical version only if required

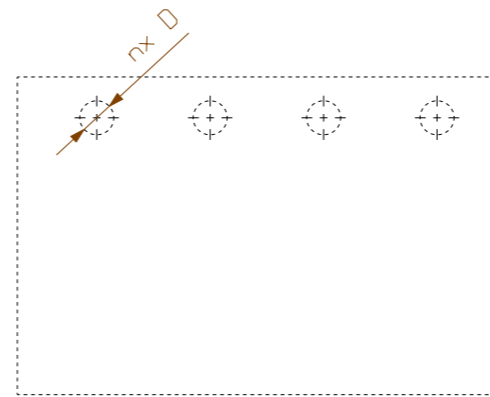
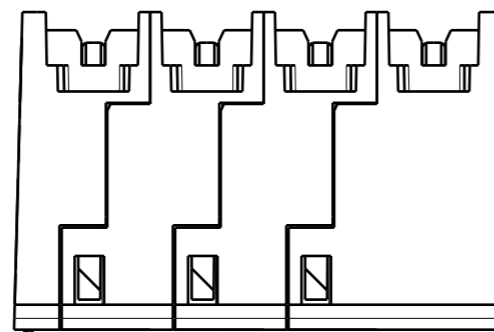
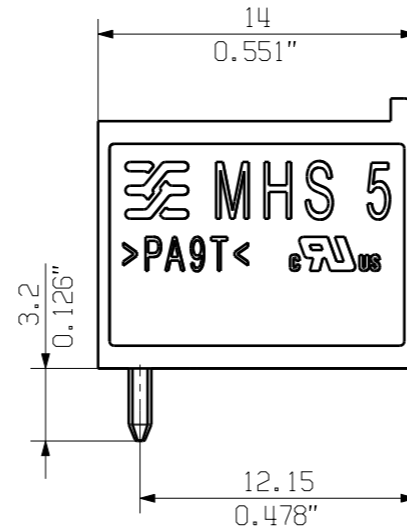
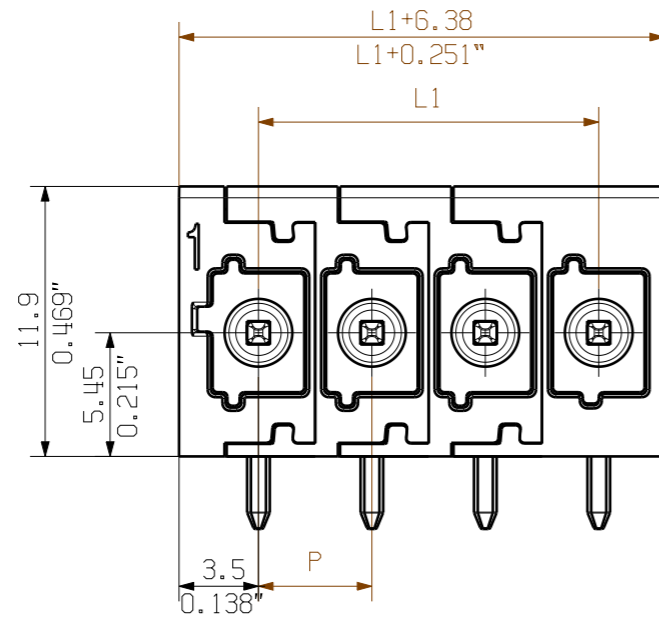

Hole pattern

12	55.00	2.165
11	50.00	1.969
10	45.00	1.772
9	40.00	1.575
8	35.00	1.378
7	30.00	1.181
6	25.00	0.984
5	20.00	0.787
4	15.00	0.591
3	10.00	0.394
2	5.00	0.197
n Poles	L1 [mm]	L1 [inch]

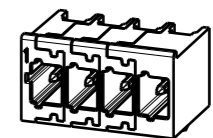

M 1/1

For the mounting of PCBs, it should be noted that the rated data relates only to the PCB components alone.

The necessary creepage and clearance paths must be observed in connection with the respective applicant in accordance to IEC 664 / VDE 0110. The current-carrying capacity and pitch tolerance is to be determined according to DIN IEC 326 part 3 very fine.

Weidmueller PCB components are tested according to the DIN EN 61984 or to the DIN EN 60947-7-4 standard, and are valid for its field of application. Provided that the components are used to the intended purpose, all requirements with respect to the occurring of electrical, mechanical, thermic and corrosive stress will be satisfied.

Further Dim. & Info. See data sheet

General tolerance:
 DIN ISO 2768-mK

	EC00004370 P028441	Prim PLM Part No.: .		Prim ERP Part No.: .	
	First Issue Date 07.05.2020	Max. nos.			72562 Drawing no. Issue no. 4
	Modification	Sheet 3 of 4 sheets			
		Drawn	Date	Name	
		Responsible	03.12.2020	Tauber-Reglin,	
Scale: 3/1 Size: A3		Approved		Schmitz, Till	
Drawings Assembly			Product file:		

MHS 5/... T3
 STIFTLAISTE
 MALE HEADER

not released

The reproduction, distribution and utilization of this document as well as the communication of its contents to others without explicit authorization is prohibited. Offenders will be held liable for the payment of damages. Weidmueller exclusively reserves the right to file for patents, utility models or designs. © Weidmueller Interface GmbH & Co. KG

Recommended reflow soldering profile

Weidmüller Interface GmbH & Co. KG
 Klingenbergstraße 16
 D-32758 Detmold
 Germany
 Fon: +49 5231 14-0
 Fax: +49 5231 14-292083
 www.weidmueller.com

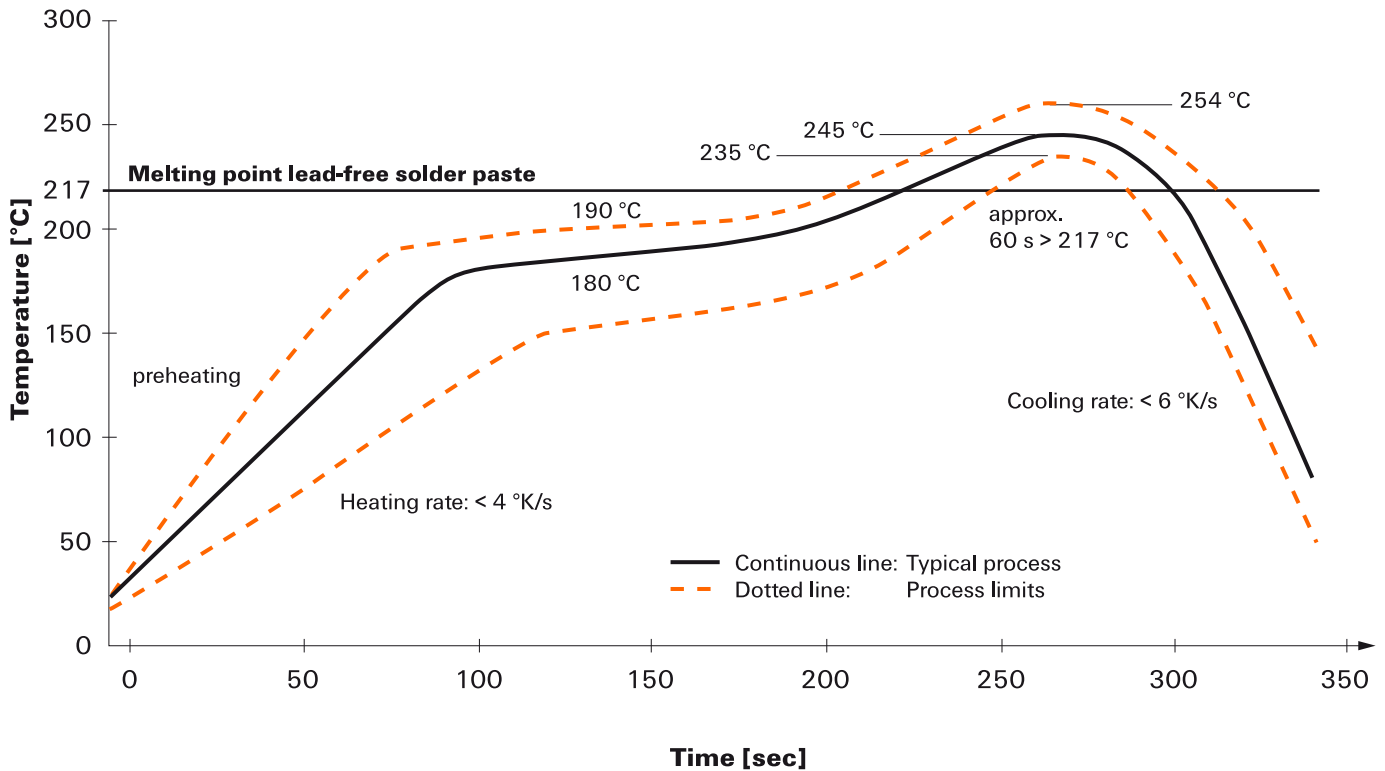

Reflow soldering profile

The perfect soldering profile for SMT Surface Mount Technology is one the most exiting question in SMT production. But there are more than one correct answer: The diagram of temperature-on-time is related to processing features of solder paste and to maximum load of components.

We have to consider the following parameters:

- Time for pre heating
- Maximum temperature
- Time above melting point
- Time for cooling
- Maximum heating rate
- Maximum cooling rate

We recommend a typical solder profile with associated process limits. With preheating components and board are prepared smoothly for the solder phase. Heating rate is typically $\leq +4\text{K/s}$. In parallel the solder paste is 'activated'. The time above melting point of 217°C the paste gets liquid and components and boards begin to connect. The maximum temperature of 245°C to 254°C should stay between 10 and 40 seconds. In the cooling phase at $\geq -6\text{K/s}$ solder is cured. Board and components cool down while avoiding cold cracks.

Wave Solder Profile

Empfohlene Wellenlötprofilen

Weidmüller Interface GmbH & Co. KG
 Klingenbergstraße 16
 D-32758 Detmold
 Germany
 Fon: +49 5231 14-0
 Fax: +49 5231 14-292083
 www.weidmueller.com

Single Wave:

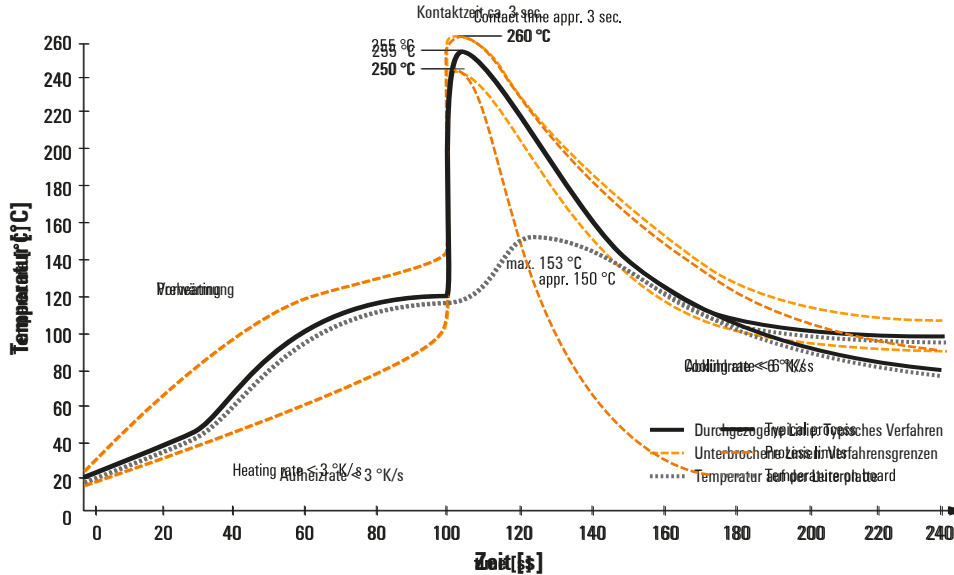

Doppel Wave:

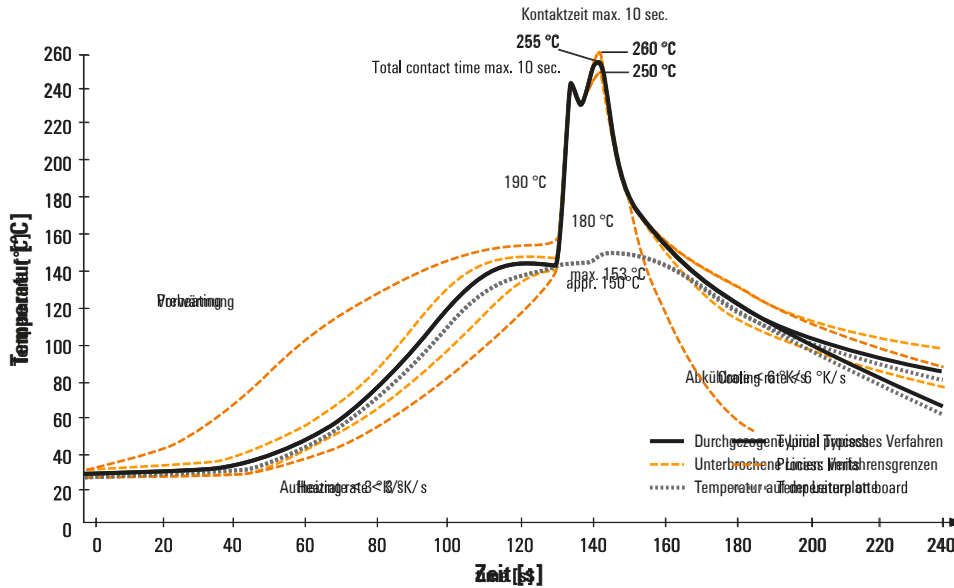

Wellenlötprofilen

Wired connection elements should be processed in accordance with the DIN EN 61760-1 standard. We have included two recommendations for practical wave soldering profiles, with which Weidmüller PCB terminals and connectors are qualified. Bedrahtete Anschlüsselemente sind in Anlehnung an die Norm DIN EN 61760-1 zu verarbeiten. Dabei sind zwei Empfehlungen für praxisbezogene Wellenlotprofile, mit denen Leiterplattenanschlussklammern und Steckverbinder von Weidmüller qualifiziert sind.

When choosing a suitable profile for your application, the following factors also need to be considered: Bei der Wahl eines passenden Profils für Ihre Anwendung sind unter anderem folgende Faktoren zu beachten:

- Stärke der Leiterplatte
- Anzahl der Schichten
- Ein-/Beidseitige Bestückung
- Produktspektrum
- Heating and cooling rates
- Aufheiz- und Abkühlrate

The single and double wave profiles each indicate the recommended operating range, including the maximum soldering temperature of 260°C. In practice, the maximum soldering temperature is quite often well below the above range. Die Einzel- und Doppelwelle zeigt jeweils den empfohlenen Verarbeitungsbereich inkl. der maximalen Löttemperatur von 260°C. In der Praxis liegt die maximale Löttemperatur sehr häufig weit unter dem o.g. Maximalprofil.

Veressete Änderungen vorbehalten.