

l) tails to fit in PC-board layout

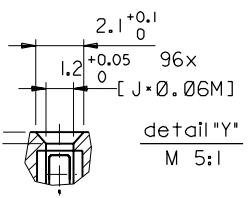
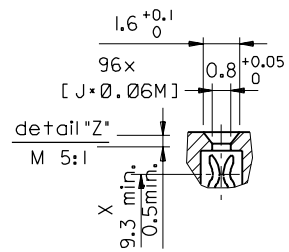
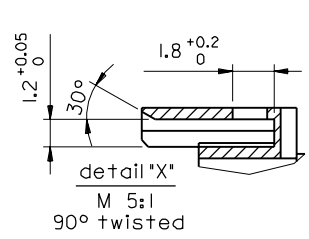
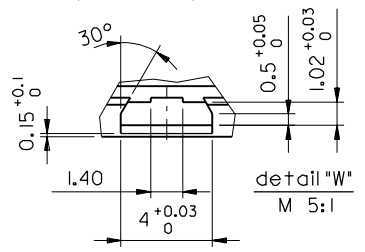
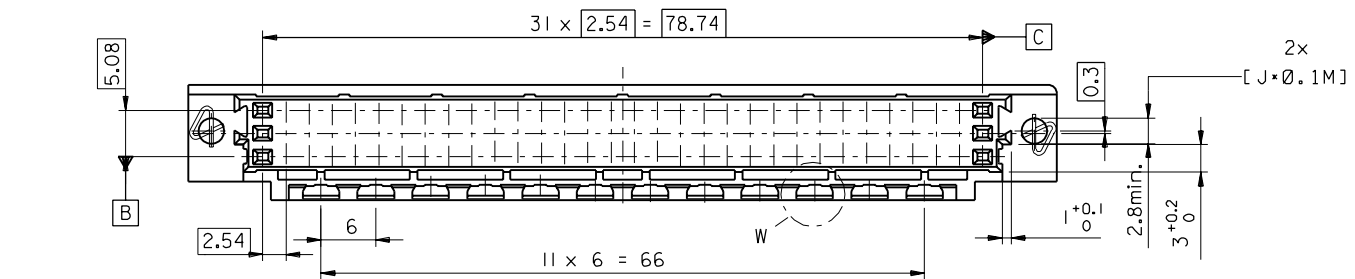
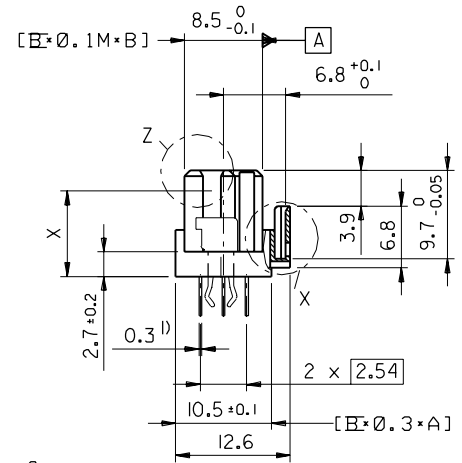
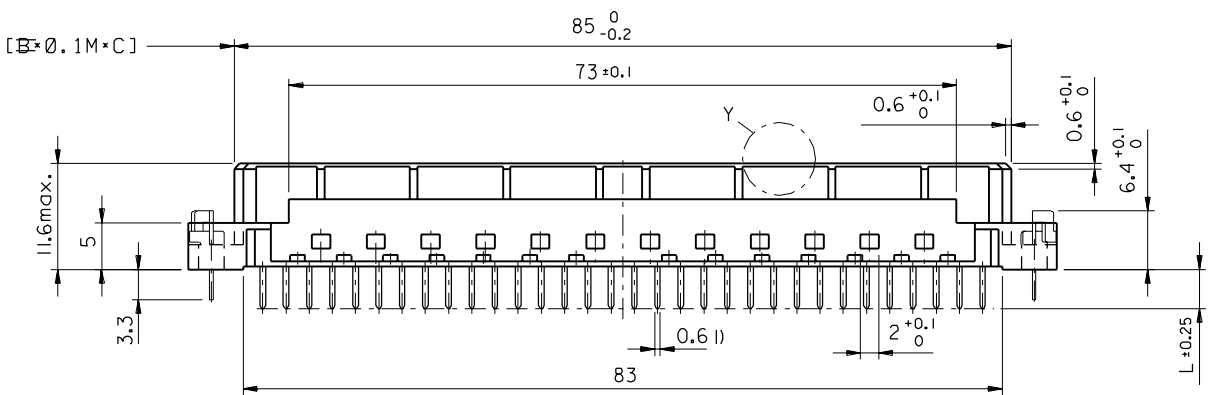

FIRST ANGLE PROJECTION		DRWG BY KN	SIGN
UNLESS OTHERWISE SPECIFIED TOLERANCES: ANGULAR ± 2°		CHK'D BY Ca	SIGN
3 PLACE ±	±	APP'D BY JB	SIGN
2 PLACE ±	±	SCALE	2:1
1 PLACE ±	±		
DRAFT WHERE APPLICABLE MUST REMAIN WITHIN DIMENSIONS			
DESIGN DIMENSION	<input checked="" type="checkbox"/> MM		
	<input type="checkbox"/> IN.		
EQUIVALENT DIMENSION	<input type="checkbox"/> MM		
	<input type="checkbox"/> IN.		
IF TWO DIMENSIONS ARE SHOWN THE UPPER IS THE DESIGN DIMENSION, LOWER IS SECONDARY			

REVISE ONLY ON CAD SYSTEM		SH.	REV.
CAD/CAM PROJECT NAME 85042000 s12		THIS DRAWING CONTAINS INFORMATION THAT IS PROPRIETARY TO MOLEX INC. & SHOULD NOT BE USED WITHOUT WRITTEN PERMISSION	
TITLE 96 pos. female connector DIN 41612 style C, + clip with coding, dimensions			
MOLEX MOLEX EUROPE		SHEET NO. DATE 2 of 2 96/04/30	
PART NO.	DWG NO.	SIZE	
SDA-85042-0001		B	

VIEW ON MATING SIDE

∩	A	A	A	A	A	A	A	A	A	A	A	A	A	A	A	A	A	A	A	A
∩																				
∩	A	A	A	A	A	A	A	A	A	A	A	A	A	A	A	A	A	A	A	A

1 2 3 4 5 6 7 8 9 10 11 12 13 14 15 16 17 18 19 20 21 22 23 24 25 26 27 28 29 30 31 32 33 34 35 36 37 38 39 40 41 42 43 44 45 46 47 48 49 50 51 52 53 54 55 56 57 58 59 60 61 62 63 64

A = 64 STANDARD CONTACTS L=4,5

Marking	Standard
Performance level	G2/0 = Contact area level2 / Termination tin
Flux proof	no
Fixing clip	no
Dimensions	SDA-85042-0001 sht.2
Technical Data	PS-85042-0001

A	G2/0	a1-32	c1-32
Contact symbol	Perform. level	Contact position number	

first release see ECN No. 2154	REVISIONS		FOR PREVIOUS REVISIONS SEE MRI LIST		REVISION ONLY ON CAD SYSTEM		SH. REV.
	LTR		LTR		SHEET NO. DATE		1 OF 1 96/05/24
UNLESS OTHERWISE SPECIFIED TOLERANCES: ANGULAR ± 2°		DRWG BY	SIGN	THIS DRAWING CONTAINS INFORMATION THAT IS PROPRIETARY TO MOLEX INC. & SHOULD NOT BE USED WITHOUT WRITTEN PERMISSION			
INCH		Cc		TITLE			
METRIC		CHK'D BY	SIGN	96 pos. female connector			
3 PLACE ± .	±	KN		acc. DIN 41612 style C			
2 PLACE ± .	±	APP'D BY	SIGN	contacts arrangement			
1 PLACE ± .	±	SCALE		MOLEX EUROPE			
DRAFT WHERE APPLICABLE MUST REMAIN WITHIN DIMENSIONS		DESIGN DIMENSION		PART NO.			
		<input type="checkbox"/> MM <input type="checkbox"/> IN.		SDA-85042-0189			
		EQUIVALENT DIMENSION		DWG NO.			
		<input type="checkbox"/> MM <input type="checkbox"/> IN.		SDA-85042-0189			
		IF TWO DIMENSIONS ARE SHOWN, THE UPPER IS THE DESIGN DIMENSION, LOWER IS SECONDARY		SIZE			
				A			