

Features

- Attenuation: 0.5 dB Steps to 31.5 dB
- Single Positive Supply
- Contains internal DC to DC converter
- Low DC Power Consumption
- Small Footprint, JEDEC Package
- Integral TTL Driver
- 50 ohm Impedance
- Lead-Free CSP-1 Package
- 100% Matte Tin Plating over Copper
- Halogen-Free “Green” Mold Compound
- 260°C Reflow Compatible
- RoHS* Compliant Version of AT90-1107

Description

The MAATCC0011 is a GaAs FET 6-bit digital attenuator with integral TTL driver. Step size is 0.5 dB providing a 31.5 dB total attenuation range. This device is in an PQFN plastic surface mount package.

The MAATCC0011 is ideally suited for use where accuracy, fast speed, very low power consumption and low costs are required. For dual supply designs without switching noise, use MAATCC0009.

Ordering Information¹

Part Number	Package
MAATCC0011	Bulk Packaging
MAATCC0011TR	1000 piece reel
MAATCC0011-TB	Sample Test Board

1. Reference Application Note M513 for reel size information.

* Restrictions on Hazardous Substances, European Union Directive 2011/65/EU.

Schematic with Off-Chip Components

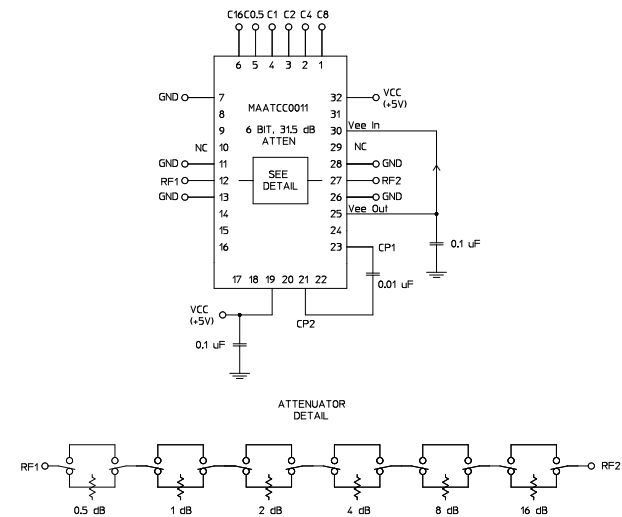

Pin Configuration²

Pin No.	Function	Pin No.	Function
1	C8	17	NC
2	C4	18	NC
3	C2	19	Vcc
4	C1	20	NC
5	C0.5	21	Cp
6	C16	22	NC
7	GND	23	Cp
8	NC	24	NC
9	NC	25	V _{EE} ⁴
10	NC ³	26	GND
11	GND	27	RF2
12	RF1	28	GND
13	GND	29	NC ³
14	NC	30	V _{EE} ⁴
15	NC	31	NC
16	NC	32	Vcc

2. The exposed pad centered on the package bottom must be connected to RF, DC and thermal ground.
3. Pins 10 & 29 must be isolated.
4. VEE is produced internally and requires a .1 μ F cap to GND. Generated noise is typical of switching DC-DC Converters.

Electrical Specifications: Freq. = DC - 4 GHz, T_A = +25°C

Parameter	Test Conditions	Units	Min.	Typ.	Max.
Insertion Loss	—	dB	—	4.5	5.1
Attenuation Accuracy	Individual Bits 0.5-1-2-4-8-16 dB Any Combination of Bits 1 to 31.5 dB	dB	±(0.3 +7% of atten setting) ±(0.5 +8% of atten setting)		
VSWR	Full Range	Ratio	—	2.0:1	2.2:1
Switching Speed	50% Control to 90%/10% RF 10% to 90% or 90% to 10%	ns	—	75 20	—
1 dB Compression	50 MHz 0.5 - 4.0 GHz	dBm	—	21 24	—
Input IP3	Two-tone inputs up to +5 dBm 50 MHz 0.5 - 4.0 GHz	dB	—	35 48	—
V _{CC}	—	V	4.75	5.0	5.25
V _{IL} V _{IH}	LOW-level input voltage HIGH-level input voltage	V	0.0 2.0	—	0.8 5.0
Input Leakage Current	V _{IN} = V _{CC} or GND	µA	-1.0	—	1.0
I _{CC} ⁵	V _{CC} min to max, Logic “0” or “1”	mA	—	6	10
Turn-on Current ⁶	For guaranteed start-up	mA	—	—	125
ΔI _{CC} (Additional Supply Current Per TTL Input Pin)	V _{CC} = max, V _{CNTRL} = V _{CC} - 2.1 V	mA	—	—	1.0
Switching Noise	Generated from DC-DC Converter with recommended capacitors @ 3.5 MHz	dBm	—	-93	—
Thermal Resistance θ _{JA}	PCB mount on FR4 material, copper trace, still air at +25°C	°C/W	—	15	—

5. During turn-on, the device requires an initial “Turn-on Current”. Once operational, I_{CC} will drop to the specified levels.

6. The DC-DC converter is guaranteed to start in 100 µs as long as the power supplies can provide a minimum of 100 mA “Turn-on Current”.

Absolute Maximum Ratings^{4,5}

Parameter	Absolute Maximum
Input Power 0.05 GHz 0.5 - 2.0 GHz	+27 dBm +34 dBm
V _{CC}	-0.5 V ≤ V _{CC} ≤ +6.0 V
V _{IN}	-0.5 V ≤ V _{IN} ≤ V _{CC} + 0.5 V
Operating Temperature	-40°C to +85°C
Storage Temperature	-65°C to +125°C

- Exceeding any one or combination of these limits may cause permanent damage to this device.
- MACOM does not recommend sustained operation near these survivability limits.

Truth Table (Digital Attenuator)

C16	C8	C4	C2	C1	C0.	Attenuation
0	0	0	0	0	0	Loss, Reference
0	0	0	0	0	1	0.5 dB
0	0	0	0	1	0	1.0 dB
0	0	0	1	0	0	2.0 dB
0	0	1	0	0	0	4.0 dB
0	1	0	0	0	0	8.0 dB
1	0	0	0	0	0	16.0 dB
1	1	1	1	1	1	31.5 dB

0 = TTL Low; 1 = TTL High

Recommended PCB Configuration⁸

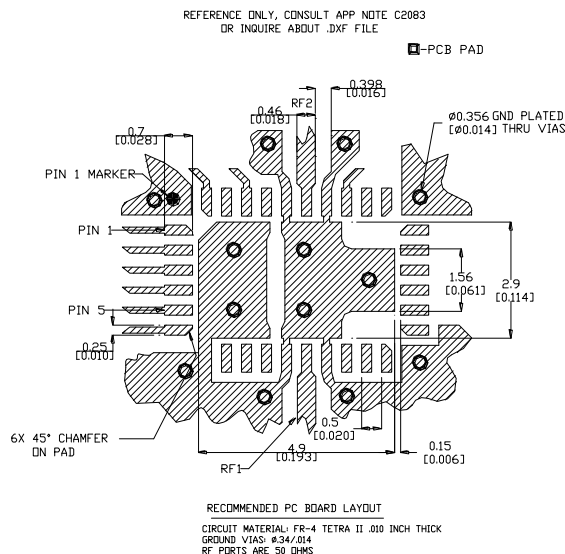

Handling Procedures

Please observe the following precautions to avoid damage:

Static Sensitivity

Gallium Arsenide Integrated Circuits are sensitive to electrostatic discharge (ESD) and can be damaged by static electricity. Proper ESD control techniques should be used when handling these devices.

Moisture Sensitivity

The MSL rating for this part is defined as Level 2 per IPC/JEDEC J-STD-020. Parts shall be stored and/or baked as required for MSL Level 2 parts.

Typical Performance Curves

Insertion Loss

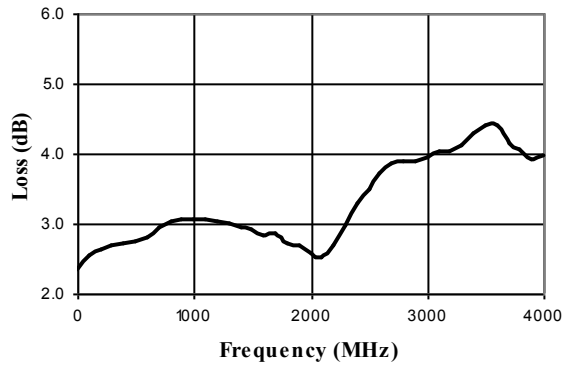

VSWR @ Insertion Loss

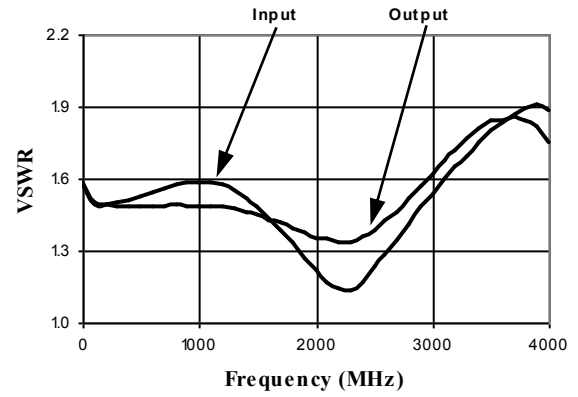

Attenuation Error, 0.5 dB Bit

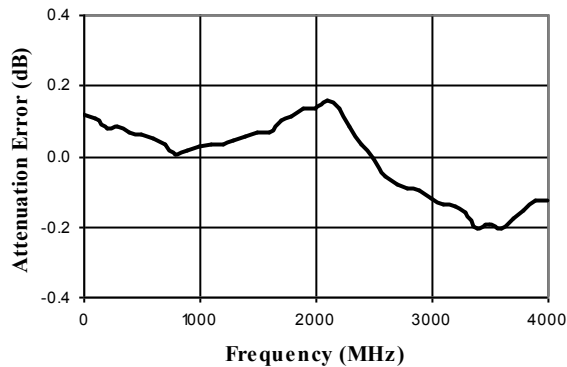

Attenuation Error, 1 dB Bit

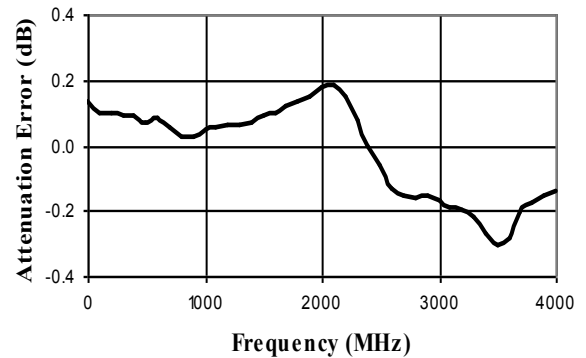

Attenuation Error, 2 dB Bit

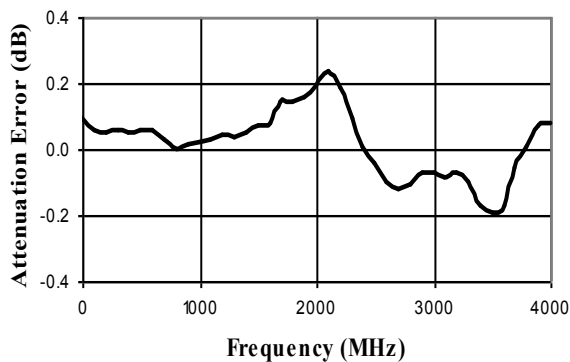

Attenuation Error, 4 dB Bit

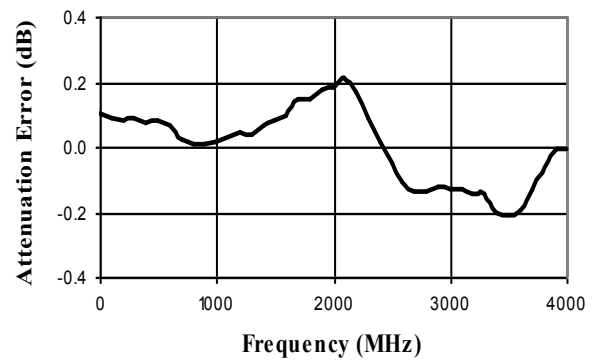

Typical Performance Curves

Attenuation Error, 8 dB Bit

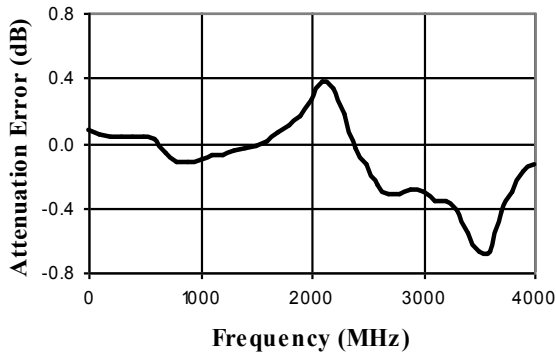

Attenuation Error, 16 dB Bit

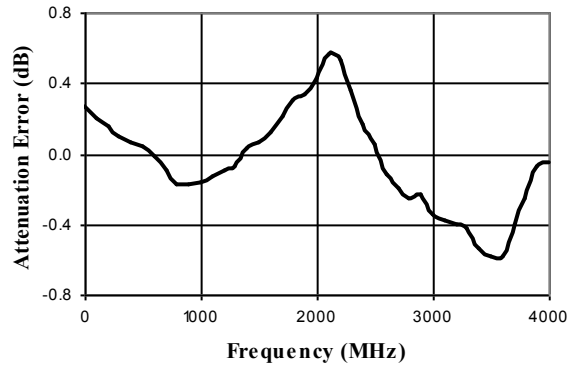

Attenuation Error, Max. Attenuation

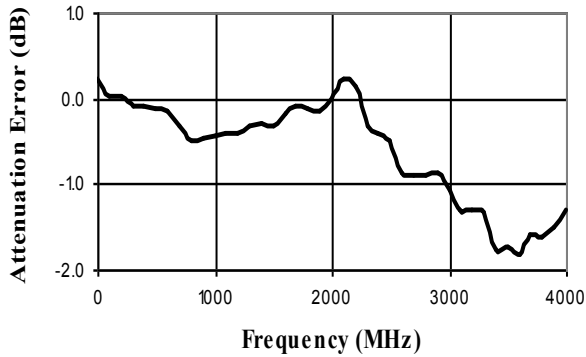

VSWR, 0.5 dB Bit

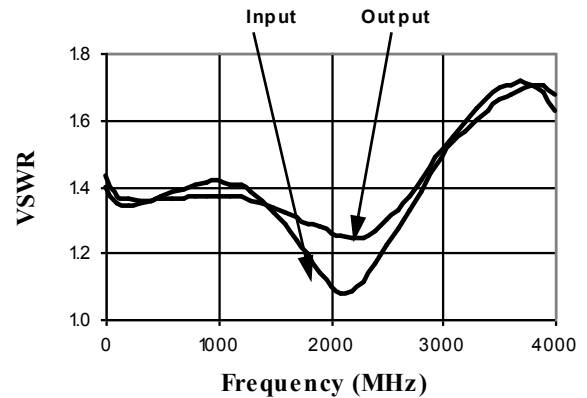

VSWR, 1 dB Bit

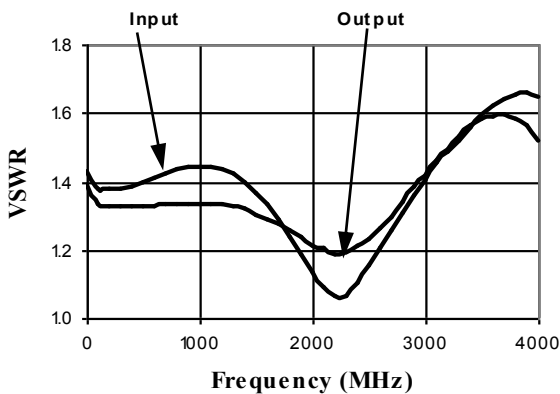

VSWR, 2 dB Bit

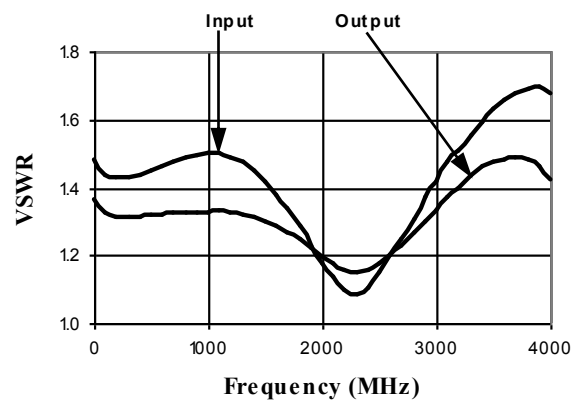

Typical Performance Curves

VSWR, 4 dB Bit

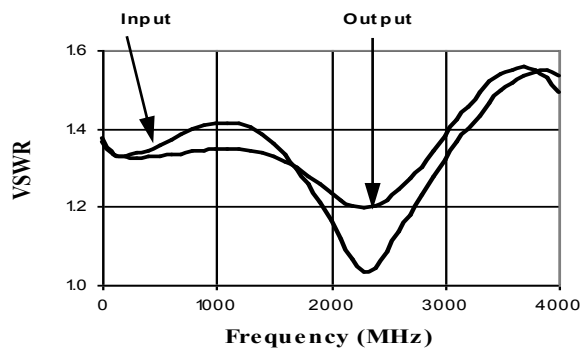

VSWR, 8 dB Bit

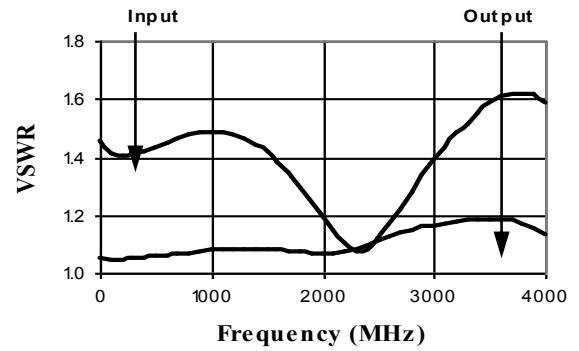

VSWR, 16 dB Bit

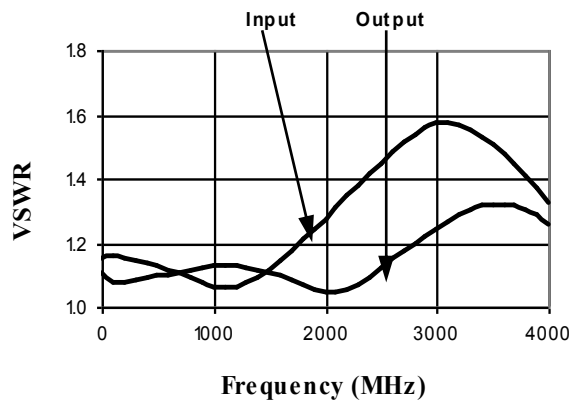

VSWR, Max. Attenuation

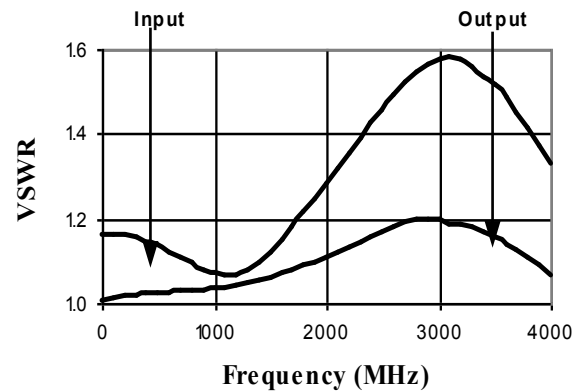

Typical Performance Curves

Typical Attenuation Deviation vs. Temperature for 0.5 dB Bit

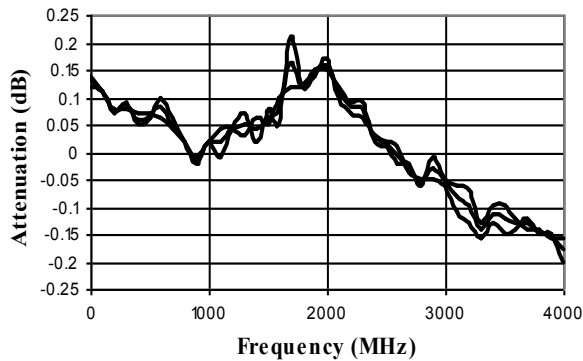

Typical Attenuation Deviation vs. Temperature for 1 dB Bit

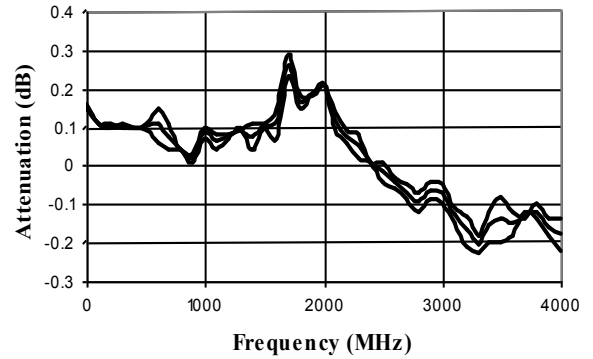

Typical Attenuation Deviation vs. Temperature for 2 dB Bit

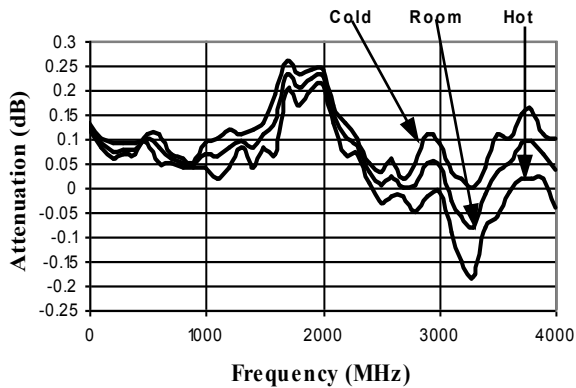

Typical Attenuation Deviation vs. Temperature for 4 dB Bit

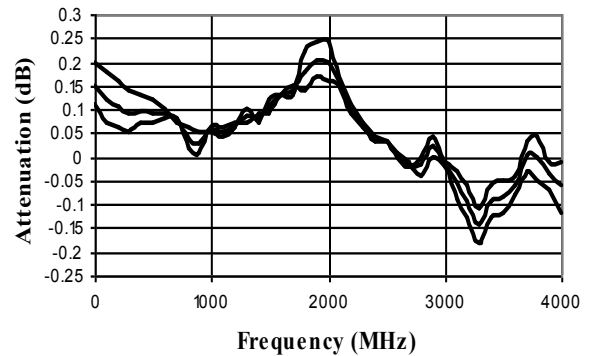

Typical Attenuation Deviation vs. Temperature for 8 dB Bit

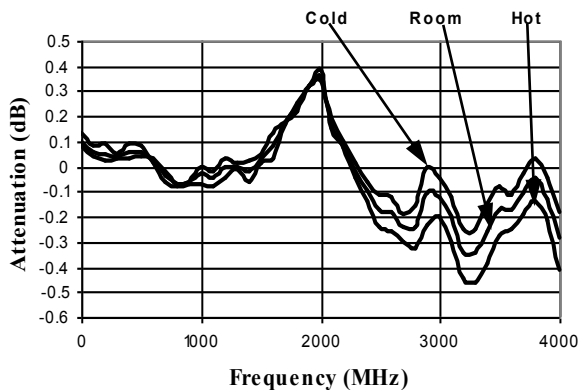

Typical Attenuation Deviation vs. Temperature for 16 dB Bit

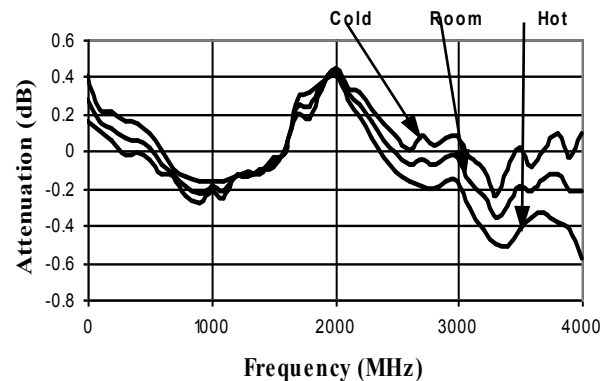

Typical Performance Curves

Typical Attenuation Deviation vs. Temperature at Maximum Attenuation

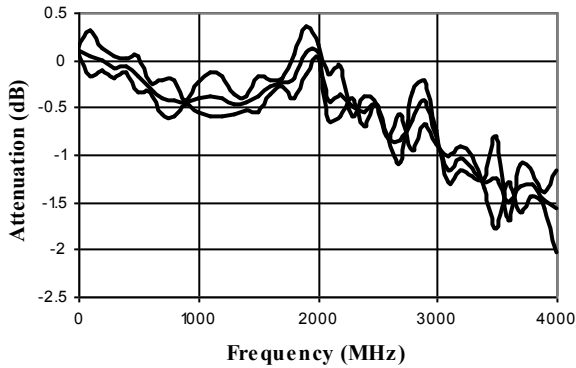

Insertion Loss vs. Temperature

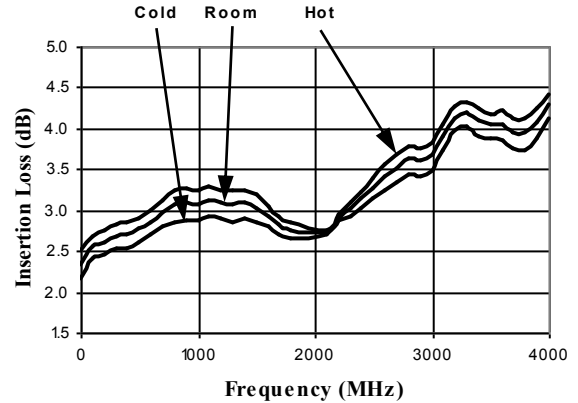

CSP-1, Lead-Free 4 x 6 mm, 32-lead PQFN[†]

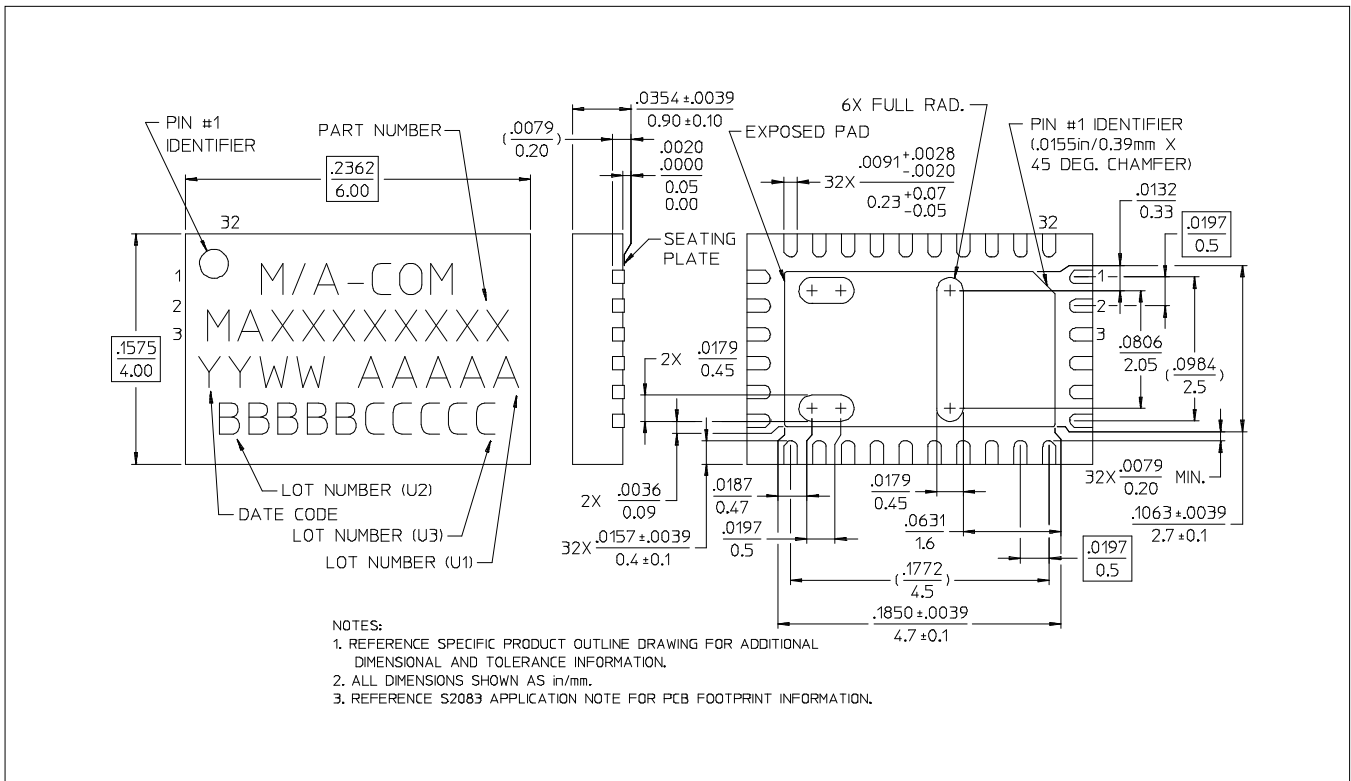

[†] Reference Application Note M538 for lead-free solder reflow recommendations.

MACOM Technology Solutions Inc. All rights reserved.

Information in this document is provided in connection with MACOM Technology Solutions Inc ("MACOM") products. These materials are provided by MACOM as a service to its customers and may be used for informational purposes only. Except as provided in MACOM's Terms and Conditions of Sale for such products or in any separate agreement related to this document, MACOM assumes no liability whatsoever. MACOM assumes no responsibility for errors or omissions in these materials. MACOM may make changes to specifications and product descriptions at any time, without notice. MACOM makes no commitment to update the information and shall have no responsibility whatsoever for conflicts or incompatibilities arising from future changes to its specifications and product descriptions. No license, express or implied, by estoppel or otherwise, to any intellectual property rights is granted by this document.

THESE MATERIALS ARE PROVIDED "AS IS" WITHOUT WARRANTY OF ANY KIND, EITHER EXPRESS OR IMPLIED, RELATING TO SALE AND/OR USE OF MACOM PRODUCTS INCLUDING LIABILITY OR WARRANTIES RELATING TO FITNESS FOR A PARTICULAR PURPOSE, CONSEQUENTIAL OR INCIDENTAL DAMAGES, MERCHANTABILITY, OR INFRINGEMENT OF ANY PATENT, COPYRIGHT OR OTHER INTELLECTUAL PROPERTY RIGHT. MACOM FURTHER DOES NOT WARRANT THE ACCURACY OR COMPLETENESS OF THE INFORMATION, TEXT, GRAPHICS OR OTHER ITEMS CONTAINED WITHIN THESE MATERIALS. MACOM SHALL NOT BE LIABLE FOR ANY SPECIAL, INDIRECT, INCIDENTAL, OR CONSEQUENTIAL DAMAGES, INCLUDING WITHOUT LIMITATION, LOST REVENUES OR LOST PROFITS, WHICH MAY RESULT FROM THE USE OF THESE MATERIALS.

MACOM products are not intended for use in medical, lifesaving or life sustaining applications. MACOM customers using or selling MACOM products for use in such applications do so at their own risk and agree to fully indemnify MACOM for any damages resulting from such improper use or sale.