

Coaxial Twin Connectors BR2 series

FOR SCREENED TWIN CABLES



GENERAL CHARACTERISTICS

- Bayonet lock coupling with polarisation
- Materials : all metal parts under stress in beryllium copper
other metal parts : brass
insulators : polyamide and diallyphtalate
gaskets : neoprene
- Plating : N.S.R. ★[®]
- Temperature range : - 40 + 100° C

F. 0-0.5 GHz

ELECTRICAL CHARACTERISTICS

- Dielectric withstanding voltage

between pins		1.500 volts RMS, 50 Hz
between pins and body		
- Maximum intensity : 3.5 Amp.
- Insulation resistance

between pins		> 10 ⁵ MΩ
between pins and body		
- Contact resistance : < 1 mΩ at 1 Amp.
- Capacity at 1 MHz

between pins		< 1.3 pF
between pins and body		< 3.2 pF

COAXIAL CABLES SUITABLE FOR BR 2 CONNECTORS

MAX EXT. DIA	CENTRAL CONDUCTOR Ø	ELEMENT Ø	BRAID Ø	SHEATH
4	1.1	1.3	3.9	4.5
5	1.1	2.2	3.9	5.5
6	1.1	2.2	5.2	6.4

BR2 series

⊗ Dimensions of plates

★ Cable mounting

plugs

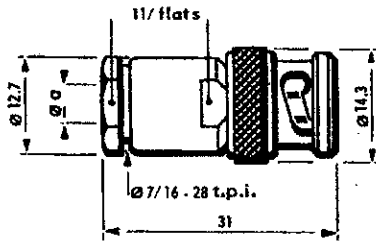

STRAIGHT PLUGS

CODE R. 605 004

CODE R. 605 005

CODE R. 605 006

EXT. DIA. OF CABLE	MAX. EXT. DIA. OF CABLE : a	CABLE ASSEMBLY	WEIGHT g.
4	4.5	A	18.5
5	5.5	A	18
6	6.4	A	17.5

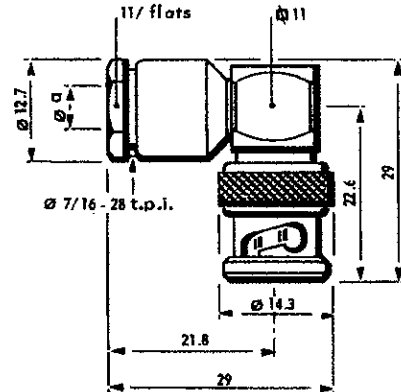

RIGHT ANGLE PLUGS

CODE R. 605 154

CODE R. 605 155

CODE R. 605 156

4	4.5	A	25
5	5.5	A	24
6	6.4	A	23

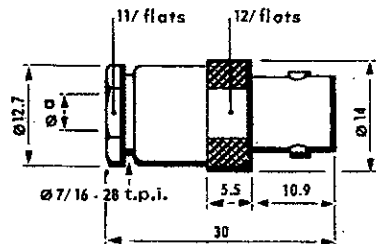

STRAIGHT JACKS

CODE R. 605 204

CODE R. 605 205

CODE R. 605 206

4	4.5	A	7
5	5.5	A	16,5
6	6.4	A	16

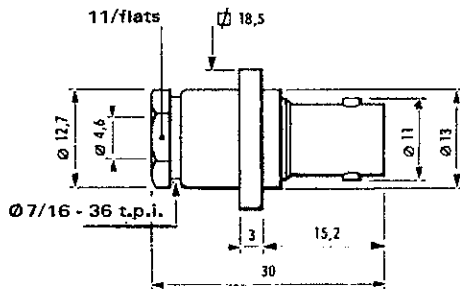

⊗ STRAIGHT JACK WITH INSULATED PLATE

CODE R. 605 253

Plate type : B

4	4.5	A	
---	-----	---	--

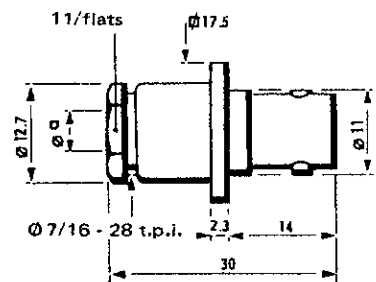

⊗ STRAIGHT JACKS WITH PLATE

CODE R. 605 254

CODE R. 605 255

CODE R. 605 256

Panel piercing : a1 or a2

Plate type : A

4	4.5	A	17
5	5.5	A	17.5
6	6.4	A	18

jacks

BR2 series receptacles

⊗ Dimensions of plate

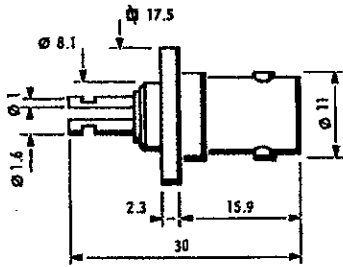

RECEPTACLE WITH PLATE

CODE R. 605 400

PANEL PIERCING	WEIGHT g.
a1 or a6	10

4 studs for printed circuit holes $\varnothing 1.2$ mm

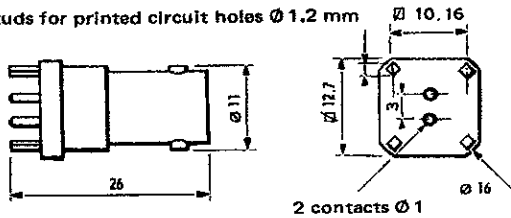

PRINTED CIRCUIT RECEPTACLE

CODE R. 605 440

On special order only

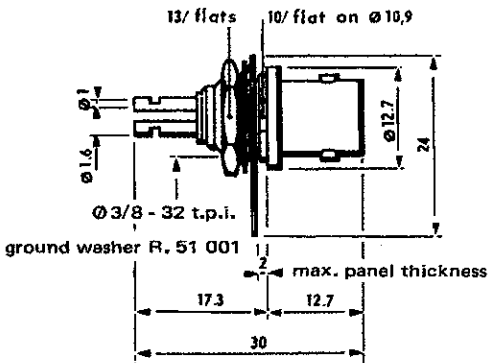

BULKHEAD RECEPTACLE

CODE R. 605 550

e4 10

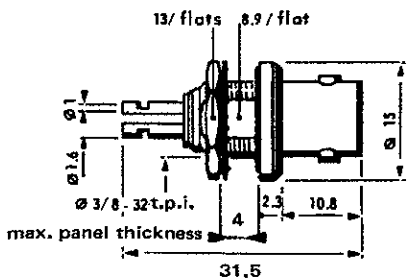

BULKHEAD RECEPTACLE

Weatherproof

CODE R. 605 600

e6 10.5

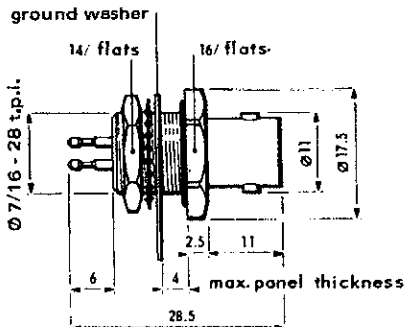

HERMETICALLY SEALED BULKHEAD RECEPTACLE

Glass sealed

CODE R. 605 610

smooth
hole
 $\varnothing 11.1$

BR2 series caps

Gasket : elastomere silicone

WITHOUT CHAIN
CODE R.141 802
 Other reference : CW. 155 A/U
 R. 90 220

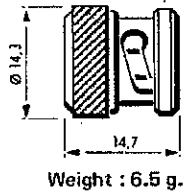

WITH BEAD CHAIN

CODE R. 141812
 Other reference : CW. 123 A/U
 R. 9 020

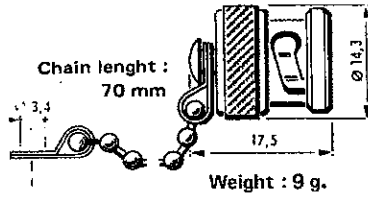

CODE R. 141 842
 Other reference : CW. 282/U
 R. 9 720

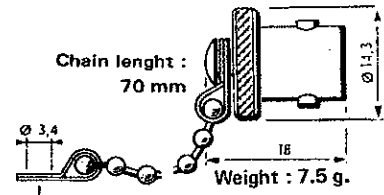

panel piercing

a

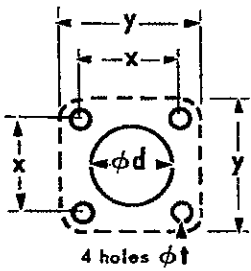

TYPE	x	y	φd	φt
a1	12,7	17,5	11,2	2,6
a2	12,7	17,5	12,9	2,6
a6	12,7	17,5	8,2	2,6

e

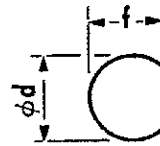

TYPE	f	φd
e4	10,1	11
e6	9	9,5

GASKET FOR PLATES

CODE R. 280 503
 Other reference : R. 9 366

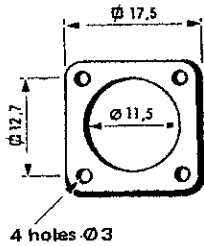

Thickness : 1.5
 Material : neoprene
 Weight : 0.4 g.

▣ DIMENSIONS OF PLATES

A

B

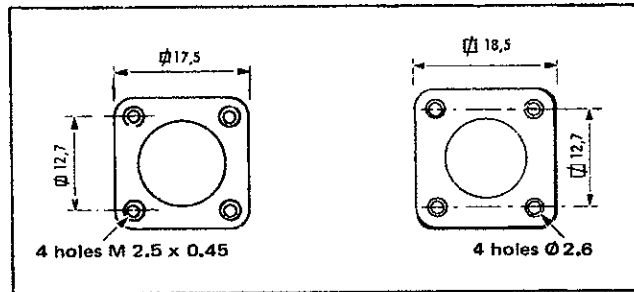

cable assembly

A

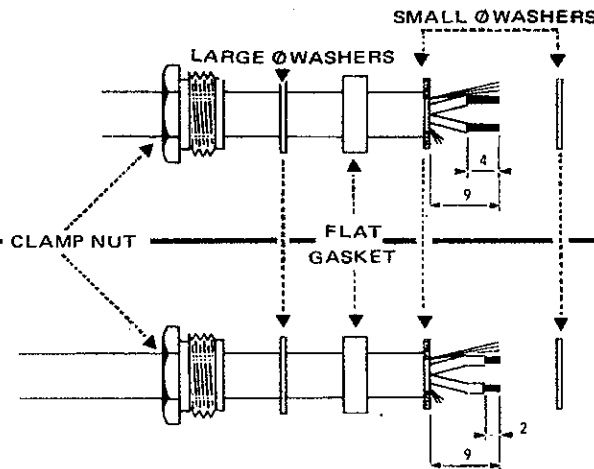
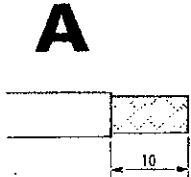

STRAIGHT PLUGS AND JACKS

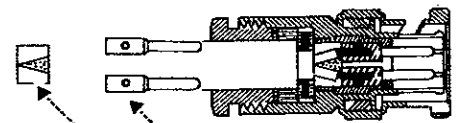

B

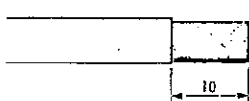

RIGHT ANGLE PLUGS

