

STELLA-G2-VSM

IESNA Type V (square) beam for wide areas such as car parks. Compatible with up to 30 mm LES size COBs. Variant with black frame.

SPECIFICATION:

Dimensions	Ø 90.0 mm
Height	25.6 mm
Fastening	screw, socket
Ingress protection classes	IP67
ROHS compliant	yes ⓘ



MATERIALS:

Component	Type	Material	Colour	Finish
STELLA-G2-VSM	Single lens	Silicone	clear	
STELLA-FRAME	Holder	PA66	black	



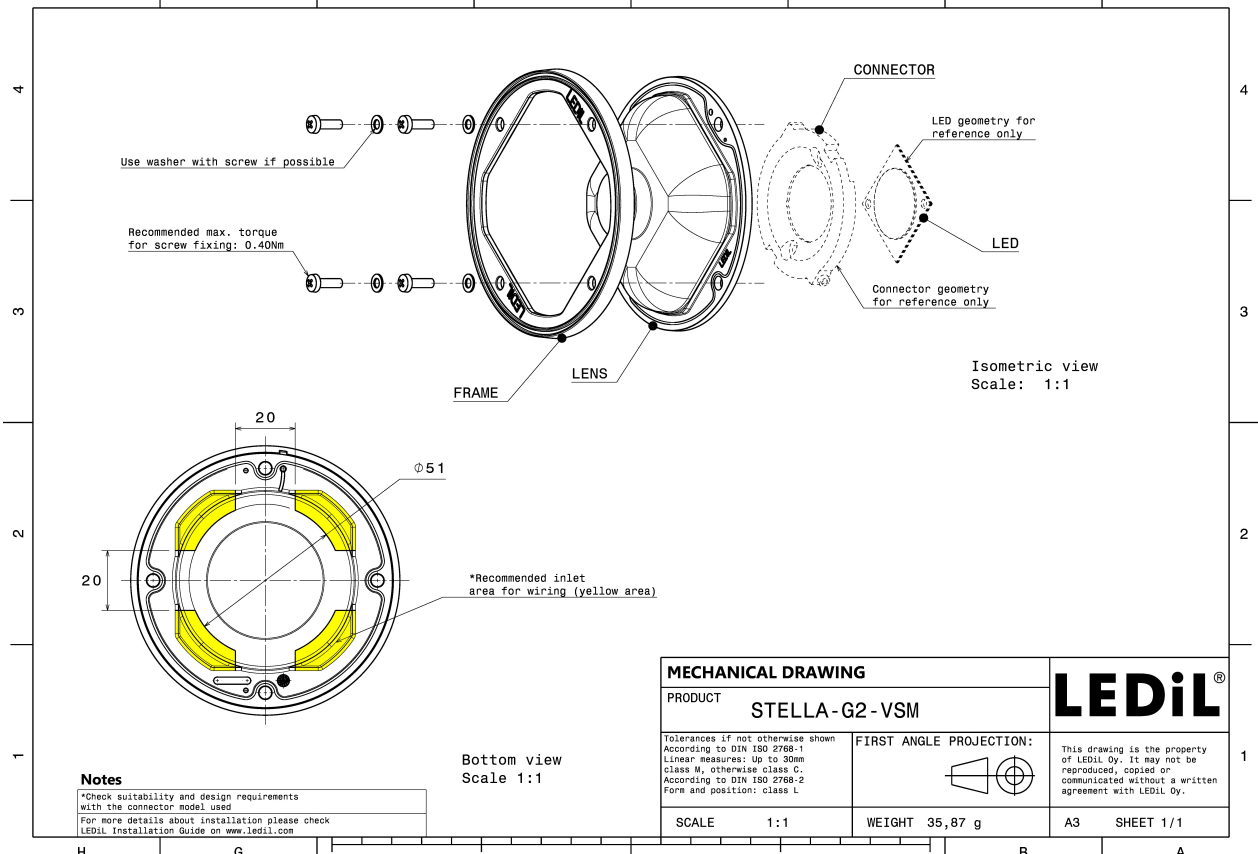
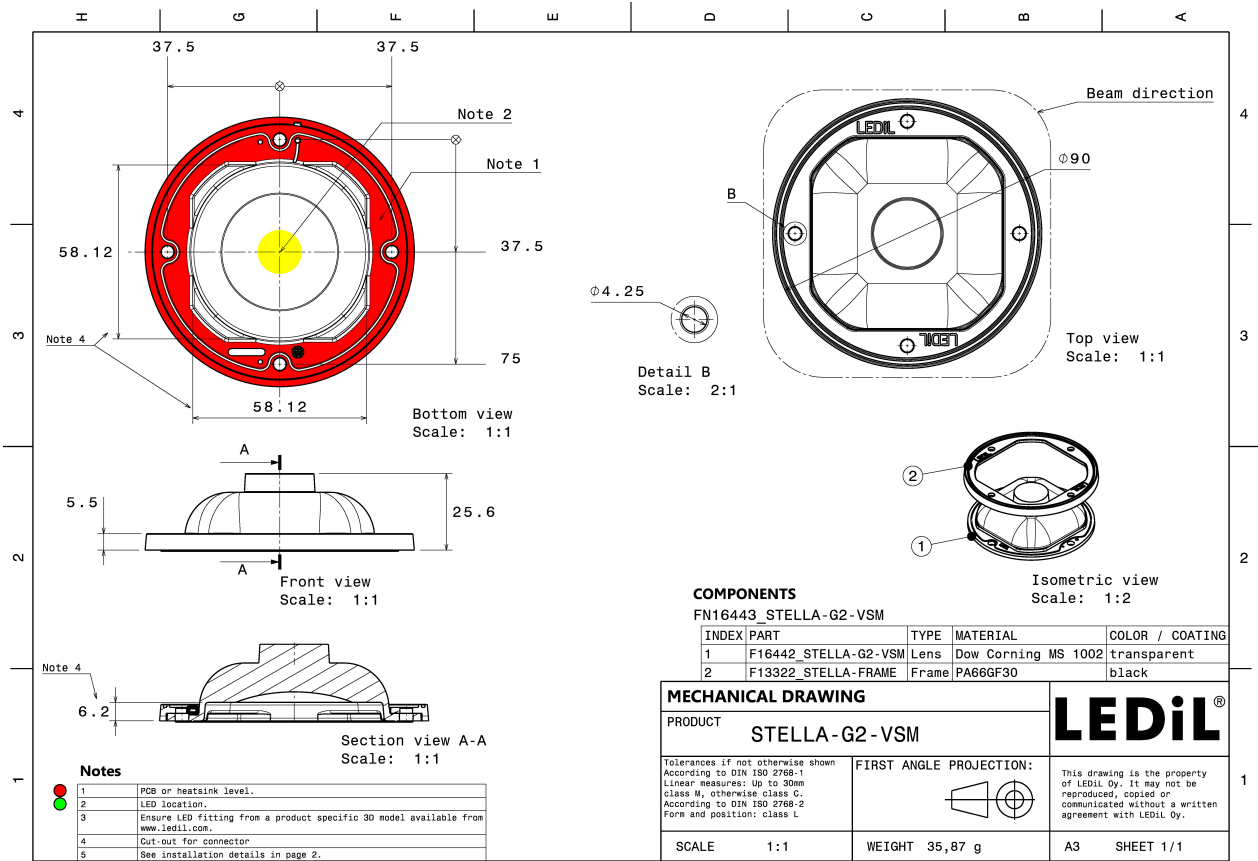

ORDERING INFORMATION:

Component	Type	Qty in box	MOQ	MPQ	Box weight (kg)
FN16443_STELLA-G2-VSM	Single lens	135	135	15	7.2
» Box size: 480 x 280 x 300 mm					

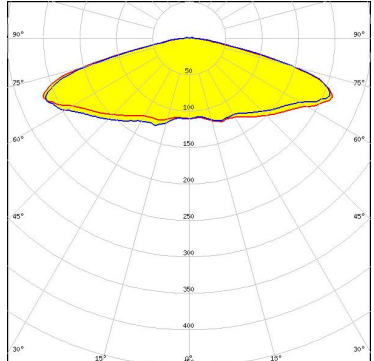

See also our general installation guide: www.ledil.com/installation_guide

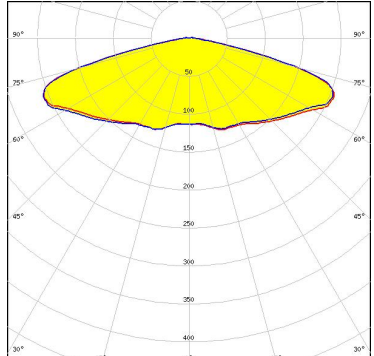
OPTICAL RESULTS (MEASURED):

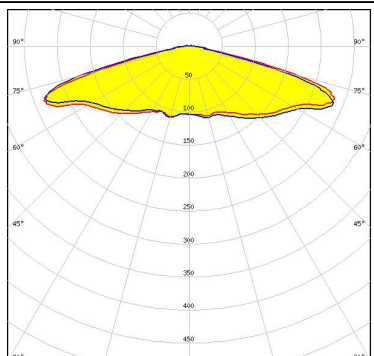
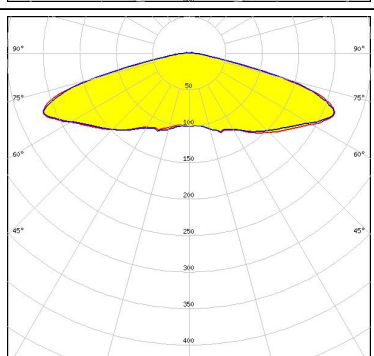
<p></p> <p>LED V22 Gen7 FWHM / FWTM Asymmetric Efficiency 91 % Peak intensity 0.3 cd/lm LEDs/each optic 1 Light colour White Required components: Bender Wirth: 431 Typ Z1</p>	
<p></p> <p>LED V22 Gen7 FWHM / FWTM Asymmetric Efficiency 92 % Peak intensity 0.3 cd/lm LEDs/each optic 1 Light colour White Required components: TE Connectivity: 2213480-1</p>	
<p></p> <p>LED VERO18 FWHM / FWTM Asymmetric Efficiency 91 % Peak intensity 0.3 cd/lm LEDs/each optic 1 Light colour White Required components:</p>	
<p>CITIZEN</p> <p>LED CLL04x/CLU04x FWHM / FWTM Asymmetric Efficiency 90 % Peak intensity 0.3 cd/lm LEDs/each optic 1 Light colour White Required components:</p>	

OPTICAL RESULTS (MEASURED):



LED LUXEON CoB 1211
FWHM / FWTM Asymmetric
Efficiency 91 %
Peak intensity 0.3 cd/lm
LEDs/each optic 1
Light colour White
Required components:
Bender Wirth: 431 Typ L3

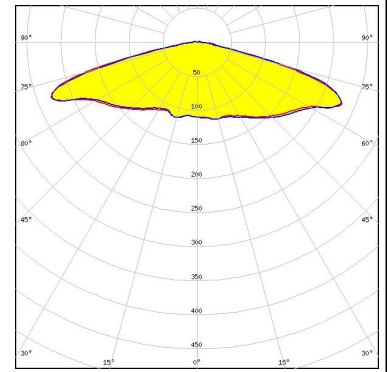

OPTICAL RESULTS (SIMULATED):



LED VERO29
 FWHM / FWTM Asymmetric
 Efficiency 93 %
 Peak intensity 0.2 cd/lm
 LEDs/each optic 1
 Light colour White
 Required components:

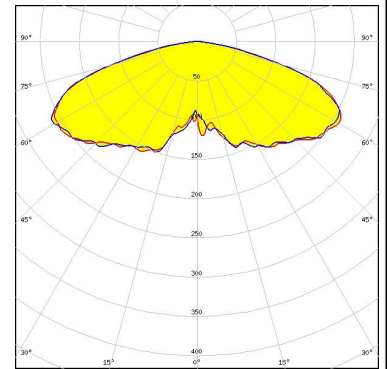

CITIZEN

LED CLL02x/CLU02x (LES10)
 FWHM / FWTM Asymmetric
 Efficiency 89 %
 Peak intensity 0.4 cd/lm
 LEDs/each optic 1
 Light colour White
 Required components:

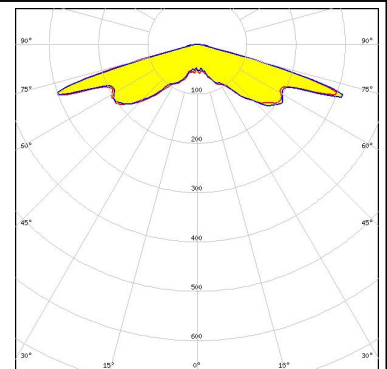

CITIZEN



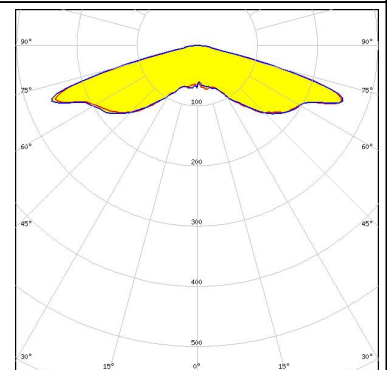

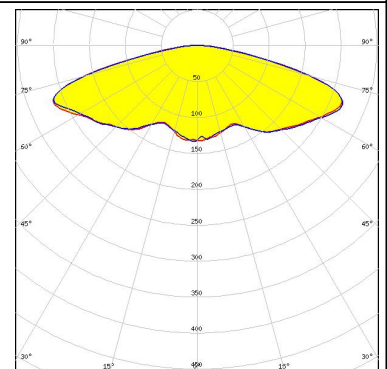

LED CLL03x/CLU03x
 FWHM / FWTM Asymmetric
 Efficiency 89 %
 Peak intensity 0.4 cd/lm
 LEDs/each optic 1
 Light colour White
 Required components:

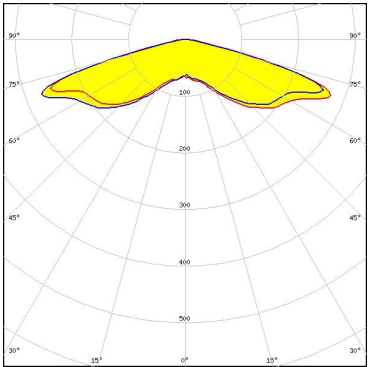

LED CMA3090
 FWHM / FWTM Asymmetric
 Efficiency 94 %
 Peak intensity 0.3 cd/lm
 LEDs/each optic 1
 Light colour White
 Required components:

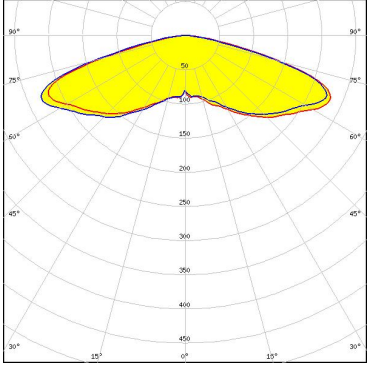

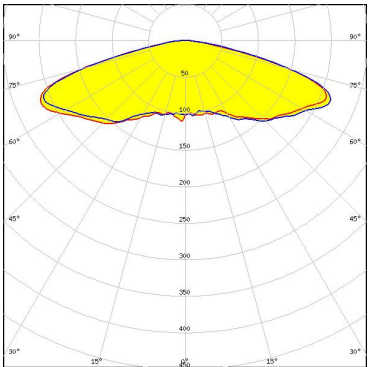
OPTICAL RESULTS (SIMULATED):

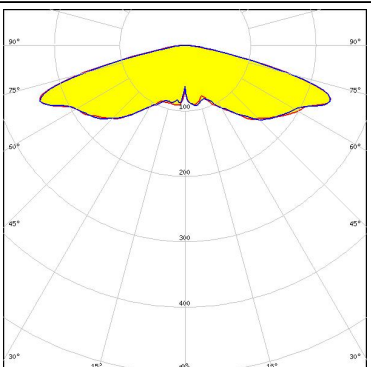
	<p>LED CMT19xx FWHM / FWTM Asymmetric Efficiency 93 % Peak intensity 0.4 cd/lm LEDs/each optic 1 Light colour White Required components: Bender Wirth: 477 Typ Z1</p>	
	<p>LED CMT28xx FWHM / FWTM Asymmetric Efficiency 93 % Peak intensity 0.3 cd/lm LEDs/each optic 1 Light colour White Required components:</p>	
	<p>LED CMT28xx FWHM / FWTM Asymmetric Efficiency 89 % Peak intensity 0.3 cd/lm LEDs/each optic 1 Light colour White Required components:</p>	
	<p>LED CXA/B 25xx FWHM / FWTM Asymmetric Efficiency 92 % Peak intensity 0.3 cd/lm LEDs/each optic 1 Light colour White Required components:</p>	

OPTICAL RESULTS (SIMULATED):

TRIDONIC

LED	SLE G7 LES17
FWHM / FWTM	Asymmetric
Efficiency	90 %
Peak intensity	0.3 cd/lm
LEDs/each optic	1
Light colour	White
Required components:	
Bender Wirth: 466 Typ L4	

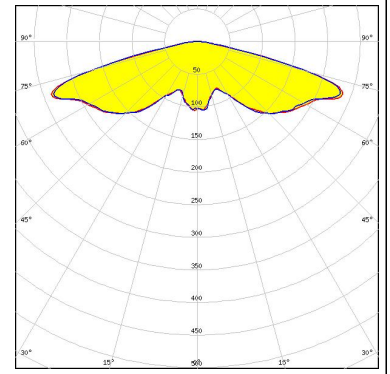

GENERAL INFORMATION:

NOTE: The typical beam angle will be changed by different color, chip size and chip position tolerance. The typical total beam angle is the full angle measured where the luminous intensity is half of the peak value.

Due to use of high power COB's with this product, special attention to proper thermal design is highly recommended. LEDiL has no liability for direct, indirect or consecutive damages arising from the LEDiL products being used outside of the recommended temperature range.

MATERIALS:

As part of our continuous research and improvement processes, and to ensure the best possible quality and availability of our products, LEDiL reserves the right to change material grades without notice.

PRODUCT DATA USER AGREEMENT AND DISCLAIMER:

The measured data in the provided downloadable LEDiL Product Datasheets and Mechanical 2D-Drawings is rounded and provided as reference for planning. LEDiL Oy's optical specifications have been verified by conducting performance testing of the products in accordance with the company's quality system. The reported data are averaged results of multiple measurements with typical variation. LEDiL Oy reserves the right to without prior notification make changes and improvements to its products.

LEDiL Oy assumes neither warranty, nor guarantee nor any other liability of any kind for the contents and correctness of the provided data. The provided data has been generated with highest diligence but the provided data may in reality not represent the complete possible variation range of all intrinsic parameters. Therefore, in certain cases a deviation from the provided data could occur.

LEDiL Oy reserves the right to undertake technical changes of its products without further notification which could lead to changes in the provided data. LEDiL Oy assumes no liability of any kind for the possible deviation from any provided data or any other damage resulting from the usage of the provided data.

The user agrees to this disclaimer and user agreement with the download or usage of the provided files.

LEDiL Oy

Joensuunkatu 13
FI-24240 SALO
Finland

LEDiL Inc.

228 West Page Street
Suite D
Sycamore IL 60178
USA

Ledil Optics Technology (Shenzhen) Co., Ltd.

405 , Block B
Casic Motor Building
Shenzhen 518057
P.R.CHINA

Local sales and technical support

[www.ledil.com/
where_to_buy](http://www.ledil.com/where_to_buy)

Shipping locations

Salo, Finland
Hong Kong, China

Distribution Partners

[www.ledil.com/
where_to_buy](http://www.ledil.com/where_to_buy)