

Data sheet | Item number: 870-541/281-489

Component terminal block; double-deck; with 2 diodes 1N4007; Bottom anode; for DIN-rail 35 x 15 and 35 x 7.5; 2.5 mm²; CAGE CLAMP®; 2,50 mm²; gray

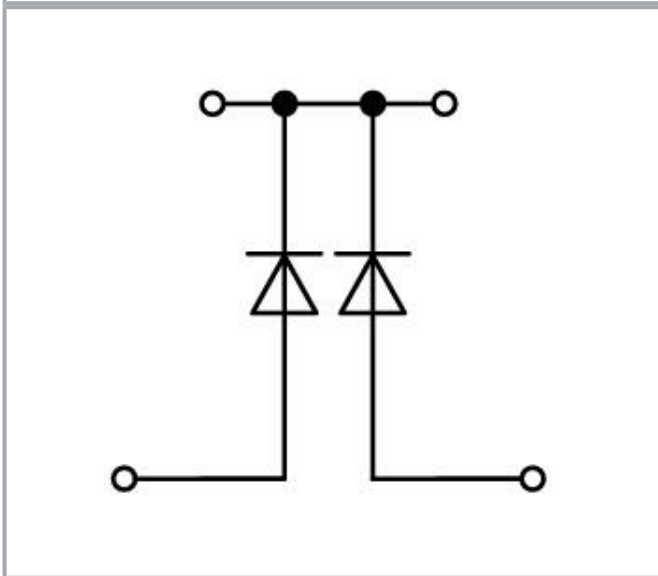

www.wago.com/870-541/281-489

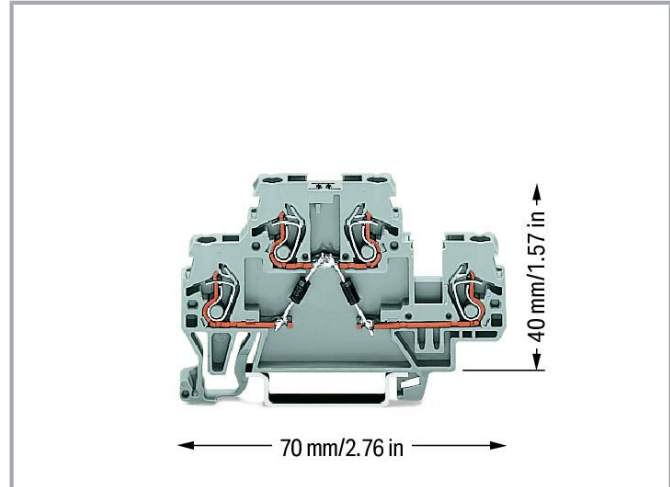
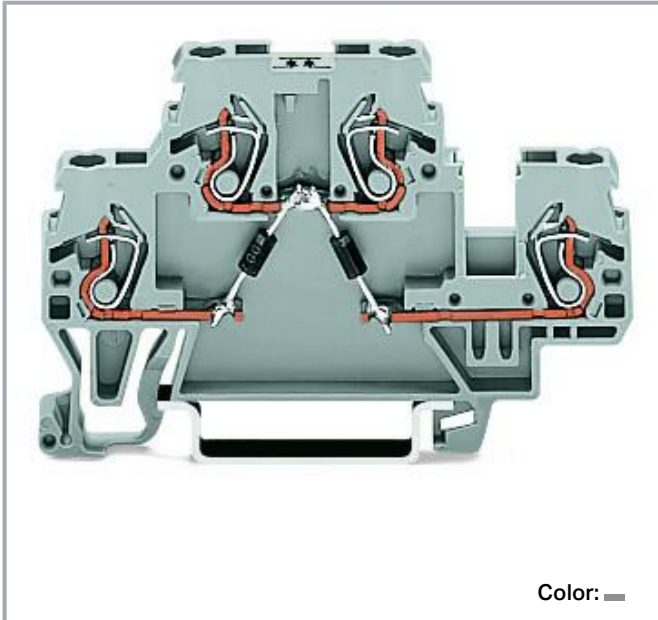

Data

Notes

Safety information

Max. insulation diameter: 4.4 mm

Subject to changes. Please also observe the further product documentation!

WAGO GmbH & Co. KG
Hansastr. 27
32423 Minden
Phone: +49571 887-0 | Fax: +49571 887-169
Email: info.de@wago.com | Web: www.wago.com

Do you have any questions about our products?
We are always happy to take your call at +49 (571) 887-44222.



Electrical data

Ratings per IEC/EN

Ratings per	IEC/EN 60947-7-1
Rated current	0.5 A

General

Nominal voltage	250 V
Reverse voltage	1,000 V

Connection data

Connection points	4
Total number of potentials	1
Number of levels	2

Connection 1

Connection technology	CAGE CLAMP®
Actuation type	Operating tool
Connectable conductor materials	Copper
Solid conductor	0.08 ... 2.5 mm ² / 28 ... 12 AWG
Fine-stranded conductor	0.08 ... 4 mm ² / 28 ... 12 AWG
Fine-stranded conductor; with insulated ferrule	0.08 ... 1.5 mm ² / 28 ... 14 AWG
Strip length	6 ... 7 mm / 0.24 ... 0.28 inches
Wiring direction	Front-entry wiring

Physical data

Width	5 mm / 0.197 inches
Height	70 mm / 2.756 inches
Depth from upper-edge of DIN-rail	40 mm / 1.575 inches

Mechanical Data

Design	horizontal type
Mounting type	DIN-35 rail
Marking level	Side marking

Subject to changes. Please also observe the further product documentation!



Material Data

Note (material data)

Information on material specifications can be found here

Color	gray
Material group	I
Insulation material	Polyamide (PA66)
Flammability class per UL94	V0
Fire load	0.192 MJ
Weight	9.3 g

Environmental requirements

Processing temperature	-35 ... +85 °C
Continuous operating temperature	-60 ... +105 °C

Commercial data

Product Group	16 (Rail Mounted Terminal Blocks with CCC)
eCl@ss 10.0	27-14-11-27
eCl@ss 9.0	27-14-11-27
ETIM 8.0	EC000903
ETIM 7.0	EC000903
PU (SPU)	50 pcs
Packaging type	box
Country of origin	DE
GTIN	4045454198602
Customs tariff number	85369010000

Environmental Product Compliance

CAS-No.	7439-92-1 79-94-7
REACH Candidate List Substance	2,2',6,6'-tetrabromo-4,4'-isopropylidenediphenol Lead
RoHS Compliance Status	Compliant,With Exemption
RoHS Exemption	7(a) 7(c)-I 7(c)-II
SCIP notification number (Austria)	ae0566cc-d8f6-470b-8904-50c4718dfe6f

Subject to changes. Please also observe the further product documentation!

WAGO GmbH & Co. KG
Hansastr. 27
32423 Minden
Phone: +49571 887-0 | Fax: +49571 887-169
Email: info.de@wago.com | Web: www.wago.com

Do you have any questions about our products?
We are always happy to take your call at +49 (571) 887-44222.

SCIP notification number (Belgium)	e5f3be77-3c73-4cff-9e97-6f650e8e55ca
SCIP notification number (Bulgaria)	59bba4c6-fc13-4c26-8ea3-fe0c942f9905
SCIP notification number (Czech Republic)	e8fb63e2-0cb6-4173-836a-36a67c3ae8aa
SCIP notification number (Denmark)	ccd04cfe-e001-485e-8208-d3dc9ae371e2
SCIP notification number (Finland)	4abe59ec-7b0c-4b8e-912c-e128ae33b494
SCIP notification number (France)	e2d768de-8ea4-46ea-bbdf-eec5d66cff89
SCIP notification number (Germany)	6d6047ed-a6a0-47c6-ab7f-6128f4584cc9
SCIP notification number (Hungary)	985a2b5b-5b97-4954-8cf5-745d162e4556
SCIP notification number (Italy)	348fe411-55d4-47f2-a174-d5cb06dc2655
SCIP notification number (Netherlands)	99f40b61-a9a5-4f60-830e-9f0440d8524f
SCIP notification number (Poland)	2e32a055-0fcc-4a45-b2b8-5014403d166a
SCIP notification number (Romania)	5b3352e5-d6ff-48f1-9ad9-aa18b2d2fada
SCIP notification number (Sweden)	cd6e4fed-f1da-46cc-ba86-757d29bf5702

Required accessories

End plate

End plate



Item no.: 870-518

End and intermediate plate; 2 mm thick; gray

www.wago.com/870-518



Item no.: 870-519

End and intermediate plate; 2 mm thick; orange

www.wago.com/870-519

Optional accessories

Tool

Operating tool



Item no.: 210-657

Operating tool; Blade: 3.5 x 0.5 mm; with a partially insulated shaft; short; multicoloured

www.wago.com/210-657



Item no.: 210-658

Operating tool; Blade: 3.5 x 0.5 mm; with a partially insulated shaft; angled; short; multicoloured

www.wago.com/210-658



Item no.: 210-720

Operating tool; Blade: 3.5 x 0.5 mm; with a partially insulated shaft; multicoloured

www.wago.com/210-720

Carrier rail

Mounting accessories

Subject to changes. Please also observe the further product documentation!

WAGO GmbH & Co. KG

Hansastr. 27













32423 Minden

Phone: +49571 887-0 | Fax: +49571 887-169

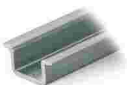
Email: info.de@wago.com | Web: www.wago.com

Do you have any questions about our products?

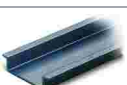
We are always happy to take your call at +49 (571) 887-44222.

	Item no.: 210-197 Steel carrier rail; 35 x 15 mm; 1.5 mm thick; 2 m long; slotted; similar to EN 60715; silver-colored	www.wago.com/210-197
	Item no.: 210-198 Copper carrier rail; 35 x 15 mm; 2.3 mm thick; 2 m long; unslotted; according to EN 60715; copper-colored	www.wago.com/210-198
	Item no.: 210-504 Steel carrier rail; 35 x 7.5 mm; 1 mm thick; 2 m long; slotted; galvanized; according to EN 60715; silver-colored	www.wago.com/210-504
	Item no.: 210-505 Steel carrier rail; 35 x 7.5 mm; 1 mm thick; 2 m long; unslotted; galvanized; according to EN 60715; silver-colored	www.wago.com/210-505
	Item no.: 210-506 Steel carrier rail; 35 x 15 mm; 1.5 mm thick; 2 m long; unslotted; galvanized; similar to EN 60715; silver-colored	www.wago.com/210-506
	Item no.: 210-508 Steel carrier rail; 35 x 15 mm; 1.5 mm thick; 2 m long; slotted; galvanized; similar to EN 60715; silver-colored	www.wago.com/210-508
	Item no.: 210-113 Steel carrier rail; 35 x 7.5 mm; 1 mm thick; 2 m long; unslotted; according to EN 60715; silver-colored	www.wago.com/210-113
	Item no.: 210-118 Steel carrier rail; 35 x 15 mm; 2.3 mm thick; 2 m long; unslotted; according to EN 60715; silver-colored	www.wago.com/210-118
	Item no.: 210-112 Steel carrier rail; 35 x 7.5 mm; 1 mm thick; 2 m long; slotted; according to EN 60715; "Hole width 25 mm; silver-colored	www.wago.com/210-112
	Item no.: 210-114 Steel carrier rail; 35 x 15 mm; 1.5 mm thick; 2 m long; unslotted; similar to EN 60715; silver-colored	www.wago.com/210-114
	Item no.: 210-115 Steel carrier rail; 35 x 7.5 mm; 1 mm thick; 2 m long; slotted; according to EN 60715; "Hole width 18 mm; silver-colored	www.wago.com/210-115
	Item no.: 210-196 Aluminum carrier rail; 35 x 8.2 mm; 1.6 mm thick; 2 m long; unslotted; similar to EN 60715; silver-colored	www.wago.com/210-196
Mounting		
Mounting accessories		
	Item no.: 209-106 Mounting carrier; for isolated mounting on DIN 35 rails; gray	www.wago.com/209-106
	Item no.: 249-116 Screwless end stop; 6 mm wide; for DIN-rail 35 x 15 and 35 x 7.5; gray	www.wago.com/249-116

Subject to changes. Please also observe the further product documentation!















Item no.: 249-117

Screwless end stop; 10 mm wide; for DIN-rail 35 x 15 and 35 x 7.5; gray

www.wago.com/249-117



Ferrule

Ferrule

	Item no.: 216-123 Ferrule; Sleeve for 1 mm ² / AWG 18; uninsulated; electro-tin plated; silver-colored	www.wago.com/216-123
	Item no.: 216-122 Ferrule; Sleeve for 0.75 mm ² / AWG 20; uninsulated; electro-tin plated; silver-colored	www.wago.com/216-122
	Item no.: 216-124 Ferrule; Sleeve for 1.5 mm ² / AWG 16; uninsulated; electro-tin plated	www.wago.com/216-124
	Item no.: 216-132 Ferrule; Sleeve for 0.34 mm ² / AWG 24; uninsulated; electro-tin plated	www.wago.com/216-132
	Item no.: 216-121 Ferrule; Sleeve for 0.5 mm ² / AWG 22; uninsulated; electro-tin plated; silver-colored	www.wago.com/216-121
	Item no.: 216-131 Ferrule; Sleeve for 0.25 mm ² / AWG 24; uninsulated; electro-tin plated; silver-colored	www.wago.com/216-131
	Item no.: 216-223 Ferrule; Sleeve for 1 mm ² / AWG 18; insulated; electro-tin plated; red	www.wago.com/216-223
	Item no.: 216-222 Ferrule; Sleeve for 0.75 mm ² / 18 AWG; insulated; electro-tin plated; gray	www.wago.com/216-222
	Item no.: 216-221 Ferrule; Sleeve for 0.5 mm ² / 20 AWG; insulated; electro-tin plated; white	www.wago.com/216-221
	Item no.: 216-224 Ferrule; Sleeve for 1.5 mm ² / AWG 16; insulated; electro-tin plated; black	www.wago.com/216-224
	Item no.: 216-321 Ferrule; Sleeve for 0.25 mm ² / AWG 24; insulated; electro-tin plated; yellow	www.wago.com/216-321
	Item no.: 216-322 Ferrule; Sleeve for 0.34 mm ² / 22 AWG; insulated; electro-tin plated; light turquoise	www.wago.com/216-322

Jumpers

Jumper

	Item no.: 870-402 Jumper; 2-way; insulated; light gray	www.wago.com/870-402
	Item no.: 870-404	www.wago.com/870-404

Subject to changes. Please also observe the further product documentation!

WAGO GmbH & Co. KG

Hansastr. 27















32423 Minden

Phone: +49571 887-0 | Fax: +49571 887-169

Email: info.de@wago.com | Web: www.wago.com

Do you have any questions about our products?

We are always happy to take your call at +49 (571) 887-44222.

	Item no.: 870-405 Jumper; 5-way; insulated; light gray	www.wago.com/870-405
	Item no.: 870-407 Jumper; 7-way; insulated; light gray	www.wago.com/870-407
	Item no.: 870-408 Jumper; 8-way; insulated; light gray	www.wago.com/870-408
	Item no.: 870-403 Jumper; 3-way; insulated; light gray	www.wago.com/870-403
	Item no.: 870-409 Jumper; 9-way; insulated; light gray	www.wago.com/870-409
	Item no.: 870-406 Jumper; 6-way; insulated; light gray	www.wago.com/870-406
	Item no.: 870-433 Jumper; from 1 to 3; insulated; light gray	www.wago.com/870-433
	Item no.: 870-435 Jumper; from 1 to 5; insulated; light gray	www.wago.com/870-435
	Item no.: 870-410 Jumper; 10-way; insulated; light gray	www.wago.com/870-410
	Item no.: 870-434 Jumper; from 1 to 4; insulated; light gray	www.wago.com/870-434
	Item no.: 870-436 Jumper; from 1 to 6; insulated; light gray	www.wago.com/870-436
	Item no.: 870-440 Jumper; from 1 to 10; insulated; light gray	www.wago.com/870-440
	Item no.: 870-437 Jumper; from 1 to 7; insulated; light gray	www.wago.com/870-437
	Item no.: 870-439 Jumper; from 1 to 9; insulated; light gray	www.wago.com/870-439
	Item no.: 870-438 Jumper; from 1 to 8; insulated; light gray	www.wago.com/870-438
	Item no.: 870-406/020-000 Delta jumper; insulated; light gray	www.wago.com/870-406/020-000

Subject to changes. Please also observe the further product documentation!

Insulation stop

Insulation stop



Item no.: 280-472

Insulation stop; 0.75 - 1 mm²; 5 pieces/strip; black

www.wago.com/280-472



Item no.: 280-470

Insulation stop; 0.08 - 0.2 mm² "s" (0.14 mm² "f-st"); 5 pieces/strip; white

www.wago.com/280-470



Item no.: 280-471

Insulation stop; 0.25 - 0.5 mm²; 5 pieces/strip; light gray

www.wago.com/280-471

Marking accessories

Marking strip



Item no.: 709-196

Marking strips; for laser printer; translucent

www.wago.com/709-196



Item no.: 709-178

Marking strips; on reel; 7.5 mm wide; not stretchable; plain; snap-on type; white

www.wago.com/709-178



Item no.: 709-177

Marking strips; on reel; 7.5 mm wide; not stretchable; plain; snap-on type; translucent

www.wago.com/709-177

Marker



Item no.: 2009-115/000-002

WMB-Inline; for Smart Printer; 1500 pieces on roll; stretchable 5 - 5.2 mm; plain; snap-on type; yellow

www.wago.com/2009-115/000-002



Item no.: 2009-115/000-007

WMB-Inline; for Smart Printer; 1500 pieces on roll; stretchable 5 - 5.2 mm; plain; snap-on type; gray

www.wago.com/2009-115/000-007



Item no.: 2009-115/000-017

WMB-Inline; for Smart Printer; 1500 pieces on roll; stretchable 5 - 5.2 mm; plain; snap-on type; light green

www.wago.com/2009-115/000-017



Item no.: 2009-115/000-023

WMB-Inline; for Smart Printer; 1500 pieces on roll; stretchable 5 - 5.2 mm; plain; snap-on type; green

www.wago.com/2009-115/000-023



Item no.: 2009-115/000-024

WMB-Inline; for Smart Printer; 1500 pieces on roll; stretchable 5 - 5.2 mm; plain; snap-on type; violet

www.wago.com/2009-115/000-024

Subject to changes. Please also observe the further product documentation!

WAGO GmbH & Co. KG

Hansastr. 27

32423 Minden

Phone: +49571 887-0 | Fax: +49571 887-169

Email: info.de@wago.com | Web: www.wago.com

Do you have any questions about our products?

We are always happy to take your call at +49 (571) 887-44222.

Item no.: 2009-145/000-006

Mini-WSB Inline; for Smart Printer; 1700 pieces on roll; stretchable 5 - 5.2 mm; plain; snap-on type; blue /000-006

www.wago.com/2009-145

Item no.: 2009-145

Mini-WSB Inline; for Smart Printer; 1700 pieces on roll; stretchable 5 - 5.2 mm; plain; snap-on type; white

www.wago.com/2009-145

Item no.: 2009-145/000-002

Mini-WSB Inline; for Smart Printer; 1700 pieces on roll; stretchable 5 - 5.2 mm; plain; snap-on type; yellow

www.wago.com/2009-145/000-002

Item no.: 2009-145/000-007

Mini-WSB Inline; for Smart Printer; 1700 pieces on roll; stretchable 5 - 5.2 mm; plain; snap-on type; gray /000-007

www.wago.com/2009-145

Item no.: 2009-145/000-005

Mini-WSB Inline; for Smart Printer; 1700 pieces on roll; stretchable 5 - 5.2 mm; plain; snap-on type; red /000-005

www.wago.com/2009-145

Item no.: 2009-145/000-012

Mini-WSB Inline; for Smart Printer; 1700 pieces on roll; stretchable 5 - 5.2 mm; plain; snap-on type; orange

www.wago.com/2009-145/000-012

Item no.: 2009-145/000-023

Mini-WSB Inline; for Smart Printer; 1700 pieces on roll; stretchable 5 - 5.2 mm; plain; snap-on type; green

www.wago.com/2009-145/000-023

Item no.: 2009-145/000-024

Mini-WSB Inline; for Smart Printer; 1700 pieces on roll; stretchable 5 - 5.2 mm; plain; snap-on type; violet

www.wago.com/2009-145/000-024



Item no.: 2009-115

WMB-Inline; for Smart Printer; 1500 pieces on roll; stretchable 5 - 5.2 mm; plain; snap-on type; white

www.wago.com/2009-115



Item no.: 248-501/000-006

Mini-WSB marking card; as card; not stretchable; plain; snap-on type; blue

www.wago.com/248-501/000-006



Item no.: 248-501/000-007

Mini-WSB marking card; as card; not stretchable; plain; snap-on type; gray

www.wago.com/248-501/000-007



Item no.: 248-501/000-002

Mini-WSB marking card; as card; not stretchable; plain; snap-on type; yellow

www.wago.com/248-501/000-002

Subject to changes. Please also observe the further product documentation!

WAGO GmbH & Co. KG

Hansastr. 27

32423 Minden

Phone: +49571 887-0 | Fax: +49571 887-169

Email: info.de@wago.com | Web: www.wago.com

Do you have any questions about our products?

We are always happy to take your call at +49 (571) 887-44222.



Item no.: 248-501/000-012
Mini-WSB marking card; as card; not stretchable; plain; snap-on type; orange

www.wago.com/248-501/000-012



Item no.: 248-501
Mini-WSB marking card; as card; not stretchable; plain; snap-on type; white

www.wago.com/248-501



Item no.: 248-501/000-017
Mini-WSB marking card; as card; not stretchable; plain; snap-on type; light green

www.wago.com/248-501/000-017

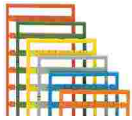

Item no.: 248-501/000-005
Mini-WSB marking card; as card; not stretchable; plain; snap-on type; red

www.wago.com/248-501/000-005



Item no.: 248-501/000-024
Mini-WSB marking card; as card; not stretchable; plain; snap-on type; violet

www.wago.com/248-501/000-024



Item no.: 248-501/000-023
Mini-WSB marking card; as card; not stretchable; plain; snap-on type; green

www.wago.com/248-501/000-023



Item no.: 793-5501/000-007
WMB marking card; as card; for terminal block width 5 - 17.5 mm; stretchable 5 - 5.2 mm; plain; snap-on type; gray

www.wago.com/793-5501/000-007



Item no.: 793-5501/000-012
WMB marking card; as card; for terminal block width 5 - 17.5 mm; stretchable 5 - 5.2 mm; plain; snap-on type; orange

www.wago.com/793-5501/000-012



Item no.: 793-5501/000-017
WMB marking card; as card; for terminal block width 5 - 17.5 mm; stretchable 5 - 5.2 mm; plain; snap-on type; light green

www.wago.com/793-5501/000-017

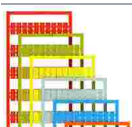

Item no.: 793-5501/000-023
WMB marking card; as card; for terminal block width 5 - 17.5 mm; stretchable 5 - 5.2 mm; plain; snap-on type; green

www.wago.com/793-5501/000-023

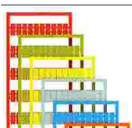

Item no.: 793-5501/000-024
WMB marking card; as card; for terminal block width 5 - 17.5 mm; stretchable 5 - 5.2 mm; plain; snap-on type; violet

www.wago.com/793-5501/000-024

Subject to changes. Please also observe the further product documentation!



Item no.: 793-501/000-002
WMB marking card; as card; not stretchable; plain; snap-on type; yellow

www.wago.com/793-501/000-002



Item no.: 793-501/000-007
WMB marking card; as card; not stretchable; plain; snap-on type; gray

www.wago.com/793-501/000-007



Item no.: 793-501/000-017
WMB marking card; as card; not stretchable; plain; snap-on type; light green

www.wago.com/793-501/000-017



Item no.: 793-501/000-012
WMB marking card; as card; not stretchable; plain; snap-on type; orange

www.wago.com/793-501/000-012



Item no.: 793-501/000-023
WMB marking card; as card; not stretchable; plain; snap-on type; green

www.wago.com/793-501/000-023



Item no.: 793-501/000-006
WMB marking card; as card; not stretchable; plain; snap-on type; blue

www.wago.com/793-501/000-006



Item no.: 793-501/000-005
WMB marking card; as card; not stretchable; plain; snap-on type; red

www.wago.com/793-501/000-005



Item no.: 793-501
WMB marking card; as card; not stretchable; plain; snap-on type; white

www.wago.com/793-501

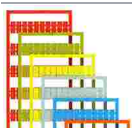

Item no.: 793-501/000-024
WMB marking card; as card; not stretchable; plain; snap-on type; violet

www.wago.com/793-501/000-024

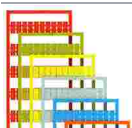

Item no.: 793-5501/000-005
WMB marking card; as card; for terminal block width 5 - 17.5 mm; stretchable 5 - 5.2 mm; plain; snap-on type; red

www.wago.com/793-5501/000-005

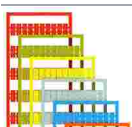

Item no.: 793-5501/000-002
WMB marking card; as card; for terminal block width 5 - 17.5 mm; stretchable 5 - 5.2 mm; plain; snap-on type; yellow

www.wago.com/793-5501/000-002

Subject to changes. Please also observe the further product documentation!



Item no.: 793-5501/000-006

WMB marking card; as card; for terminal block width 5 - 17.5 mm; stretchable 5 - 5.2 mm; plain; snap-on type; blue www.wago.com/793-5501/000-006



Item no.: 793-5501

WMB marking card; as card; for terminal block width 5 - 17.5 mm; stretchable 5 - 5.2 mm; plain; snap-on type; white www.wago.com/793-5501



Item no.: 2009-115/000-012

WMB-Inline; for Smart Printer; 1500 pieces on roll; stretchable 5 - 5.2 mm; plain; snap-on type; orange www.wago.com/2009-115/000-012



Item no.: 2009-115/000-006

WMB-Inline; for Smart Printer; 1500 pieces on roll; stretchable 5 - 5.2 mm; plain; snap-on type; blue www.wago.com/2009-115/000-006

Protective warning marker

Cover



Item no.: 280-405

Protective warning marker; for 5 terminal blocks; with high-voltage symbol, black; yellow www.wago.com/280-405

Downloads

Documentation

Bid Text

870-541/281-489 X81 - Datei	2019 Feb 19	xml 3.3 kB	Download
870-541/281-489 doc - Datei	2017 May 31	doc 25.1 kB	Download

Additional Information

Technical Section Technical explanations		pdf 2.2 MB	Download
---	--	---------------	----------

CAD/CAE-Data

CAE data

EPLAN Data Portal 870-541/281-489		URL	Download
WSCAD Universe 870-541/281-489		URL	Download
WSCAD Universe 870-541/281-489		URL	Download

Subject to changes. Please also observe the further product documentation!

EPLAN Data Portal 870-541/281-489	URL	Download
-----------------------------------	---------------------	--------------------------

ZUKEN Portal 870-541/281-489	URL	Download
------------------------------	---------------------	--------------------------

CAD data

2D/3D Models 870-541/281-489	URL	Download
------------------------------	---------------------	--------------------------

Environmental Product Compliance

Compliance Search

Environmental Product Compliance 870-541/281-489	URL	Download
--	---------------------	--------------------------

Component terminal block; double-deck; with 2 diodes 1N4007; Bottom anode; for DIN-rail 35 x 15 and 35 x 7.5; 2.5 mm²; CAGE CLAMP®; 2,50 mm²; gray

Installation Notes

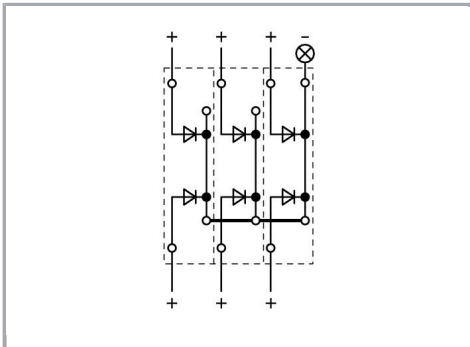

Collective fault signals can be created using the following terminal blocks:

870-541/281-489 or 870-541/281-490

Subject to changes. Please also observe the further product documentation!