

**PLEASE CHECK WWW.MOLEX.COM FOR LATEST PART INFORMATION**

**Part Number:** [54104-4696](#)  
**Status:** **Active**  
**Description:** 0.50mm Pitch FFC/FPC Connector, Right Angle, SMT, ZIF, Top Contact Style, 46 Circuits, Lead-Free

**Documents:**

[3D Model](#) [Packaging Specification SPK-54104-001 \(PDF\)](#)  
[Drawing \(PDF\)](#) [RoHS Certificate of Compliance \(PDF\)](#)  
[Product Specification PS-54104-069 \(PDF\)](#)

**Agency Certification**

CSA LR19980  
 UL E29179

**General**

Product Family FFC/FPC Connectors  
 Series [54104](#)  
 Product Name N/A  
 UPC 822348112883

**Physical**

Circuits (Loaded) 46  
 Color - Resin Natural  
 Contact Position Top  
 Durability (mating cycles max) 20  
 Entry Angle 90° Angle  
 Flammability 94V-0  
 Mated Height 2.00mm  
 Material - Metal Phosphor Bronze  
 Material - Plating Mating Tin-Bismuth  
 Material - Plating Termination Tin-Bismuth  
 Material - Resin High Temperature Thermoplastic  
 Net Weight 515.700/mg  
 Number of Rows 1  
 Orientation Right Angle  
 PCB Locator No  
 PCB Retention None  
 Packaging Type Embossed Tape on Reel  
 Pitch - Mating Interface 0.50mm  
 Plating min - Mating 1.016µm  
 Plating min - Termination 1.016µm  
 Polarized to PCB Yes  
 Stackable No  
 Surface Mount Compatible (SMC) N/A  
 Temperature Range - Operating -40°C to +85°C  
 Termination Interface: Style Surface Mount  
 Wire/Cable Type FFC/FPC

**Electrical**

Current - Maximum per Contact 0.5A  
 Voltage - Maximum 50V

**Material Info**

**Reference - Drawing Numbers**

[Packaging Specification](#) SPK-54104-001  
[Product Specification](#) PS-54104-069, RPS-54104-075, RPS-54104-078

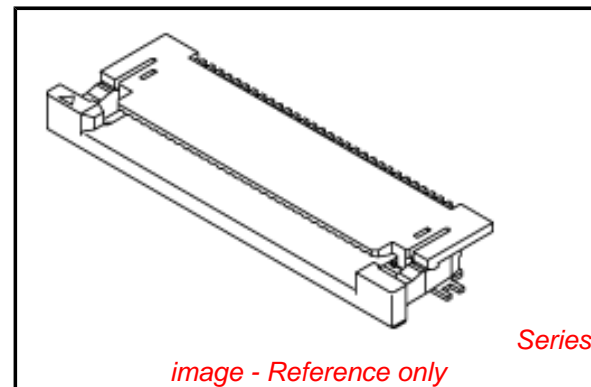

*image - Reference only*

**EU RoHS**

**ELV and RoHS  
Compliant**

**REACH SVHC**

Not Reviewed

**Low-Halogen Status**

**Not Low-Halogen**

**China RoHS**



**Need more information on product  
environmental compliance?**

Email [productcompliance@molex.com](mailto:productcompliance@molex.com)  
 For a multiple part number RoHS Certificate of Compliance, [click here](#)

Please visit the [Contact Us](#) section for any non-product compliance questions.

**Search Parts in this Series**

[54104Series](#)

This document was generated on 03/08/2013

**PLEASE CHECK [WWW.MOLEX.COM](http://WWW.MOLEX.COM) FOR LATEST PART INFORMATION**