

THIS IS A C.A.D. GENERATED DRAWING
DO NOT MAKE MANUAL REVISIONS TO MASTER.

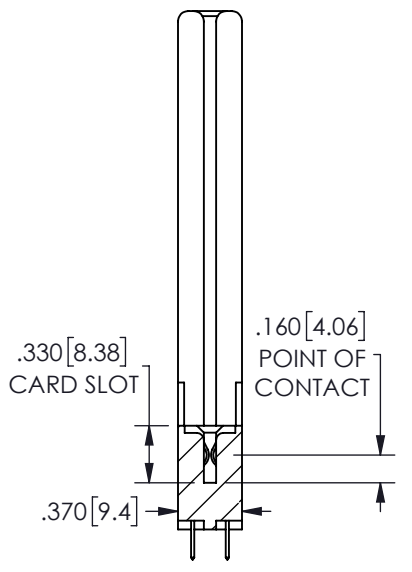

ISSUE NUMBER	
ORIGINAL	①

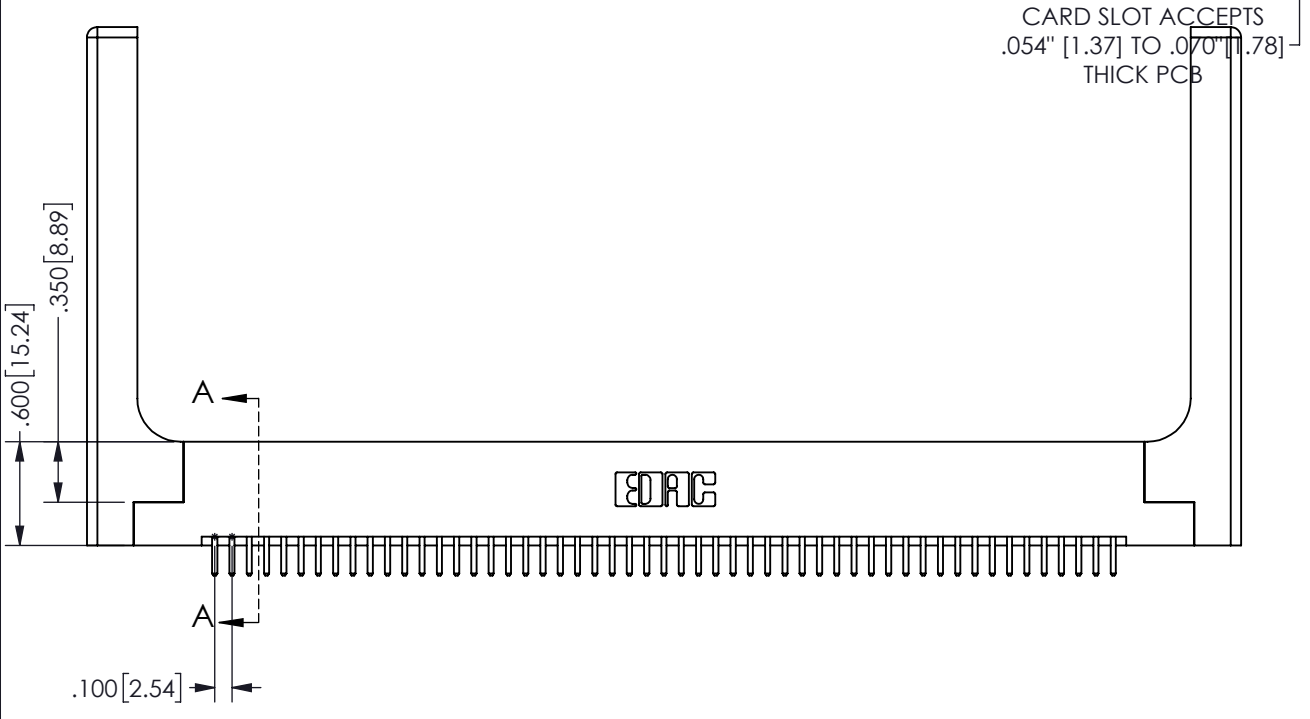
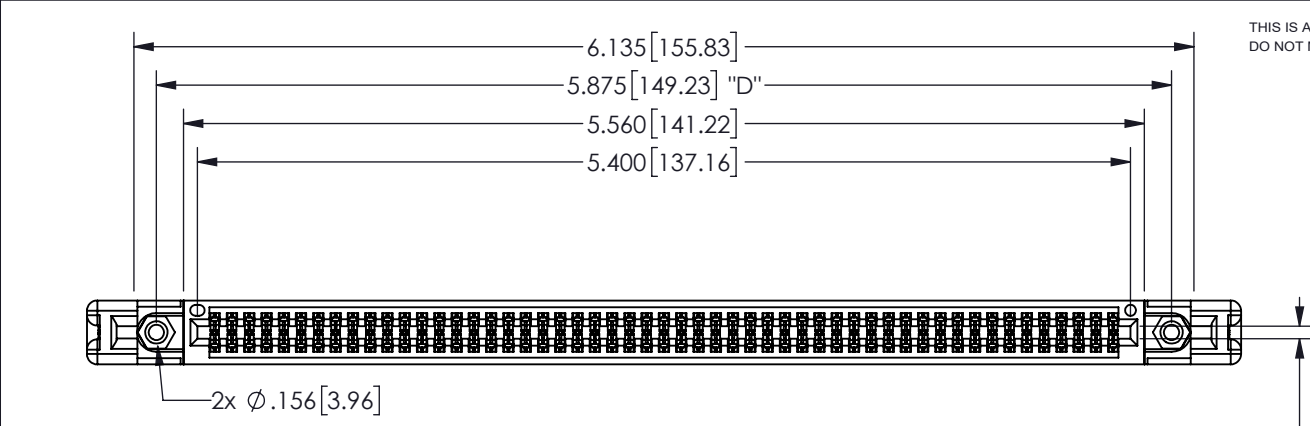

SECTION A-A

Contact Dimensions:
520-P.C. Tail .030x.018(0.76x0.46) - Tail LG=.175(4.45)
.100 (2.54) Contact Spacing x .200 (5.08) Row Spacing

345/395 SERIES CARD EDGE CONNECTOR PART NUMBER: 345-106-520-258		ACAD REFERENCE NO.	345-ENG-MASTER
		DRAWN: R.STA.MONICA	DATE: MAY.16/2017
 EDAC INC TORONTO, ONTARIO CANADA YOUR CONNECTION TO QUALITY & SERVICE		CHECKED:	DATE:
		SCALE: NTS	SHEET 1 OF 2
THESE DRAWINGS AND SPECIFICATIONS ARE THE PROPERTY OF EDAC INC. AND SHALL NOT BE REPRODUCED, OR COPIED OR USED AS THE BASIS FOR THE MANUFACTURE OR SALE OF APPARATUS WITHOUT WRITTEN PERMISSION.		DRAWING NUMBER	ISSUE
		345-ENG-MASTER	1

Contact Description:
559-90 Degree Bend (Code 541 Contacts)

THIS IS A C.A.D. GENERATED DRAWING
 DO NOT MAKE MANUAL REVISIONS TO MASTER.



ISSUE NUMBER	
ORIGINAL	①



Contact Code 555



Contact Code 556



Contact Code 558



Contact Code 559



Contact Code 560

- INSULATOR MATERIAL: THERMOPLASTIC POLYESTER, UL 94V-0
- DAP MATERIAL AVAILABLE UPON REQUEST
- CONTACT MATERIAL: COPPER ALLOY
- CONTACT PLATING: GOLD ON THE MATING AREA, TIN PLATING ON THE CONTACT TAILS, NICKEL UNDERPLATE

**345/395 SERIES CARD EDGE CONNECTOR
 CONTACT CODE 555,556,558,559,560 DIMENSIONS**



EDAC INC
 TORONTO, ONTARIO
 CANADA

YOUR CONNECTION TO QUALITY & SERVICE

THESE DRAWINGS AND SPECIFICATIONS
 ARE THE PROPERTY OF EDAC INC. AND
 SHALL NOT BE REPRODUCED, OR COPIED
 OR USED AS THE BASIS FOR THE
 MANUFACTURE OR SALE OF APPARATUS
 WITHOUT WRITTEN PERMISSION.

ACAD REFERENCE NO.	345-ENG-MASTER
DRAWN: R.STA.MONICA	DATE: MAY.16/2017
CHECKED:	DATE:
SCALE: 1:1	SHEET 2 OF 2
DRAWING NUMBER 345-ENG-MASTER	ISSUE 1