

FA-2016E2-C

SHOCK ABSORBER - ADJUSTABLE

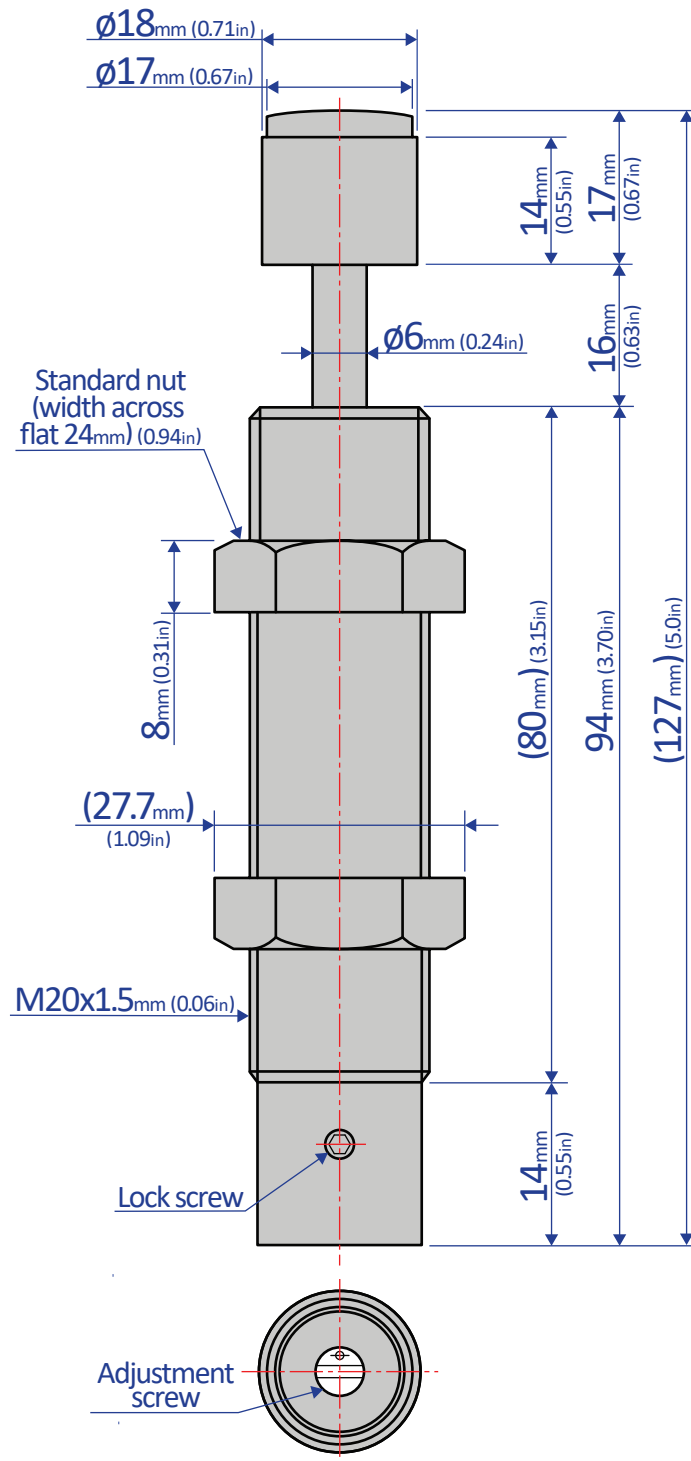

Bansbach
easylift®

50 West Drive • Melbourne, Florida 32904
(321) 253-1999 • www.easylift.com • www.damper.net