

PART NUMBER	CABLE TYPE	ØD (µm)	ØX (µm)	LOGO
1060598000	MULTIMODE	127 +3/-0	3	NO
1060598008	SINGLE MODE	125.5 +0.5/-0	0.5	
1060598016	N/A	N/A	N/A	
1060598020	MULTIMODE	127 +3/-0	3	YES
1060598028	SINGLE MODE	125.5 +0.5/-0	0.5	
1060598017	N/A	N/A	N/A	

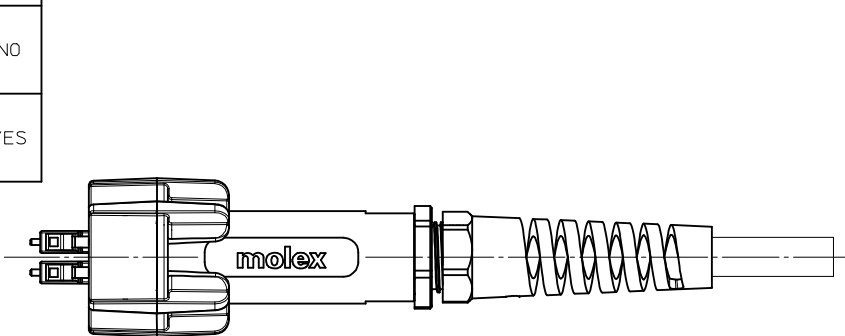

1060598020 / 1060598028 SHOWN

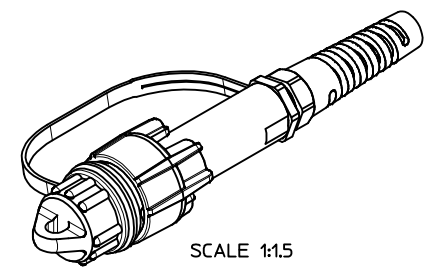

SCALE 1:1.5

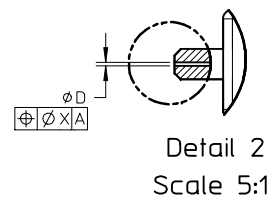

Detail 2
Scale 5:1

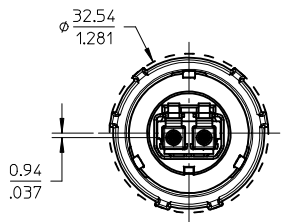
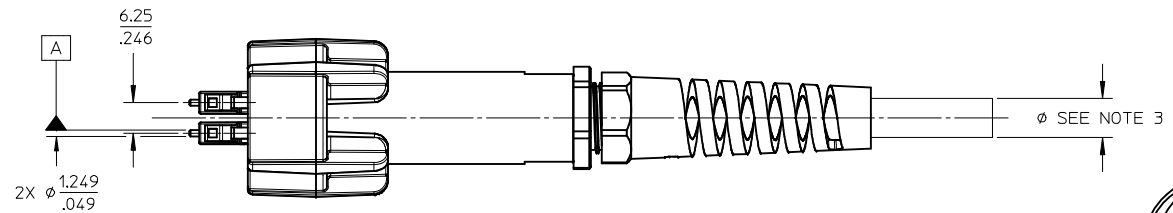

SEE Detail 2

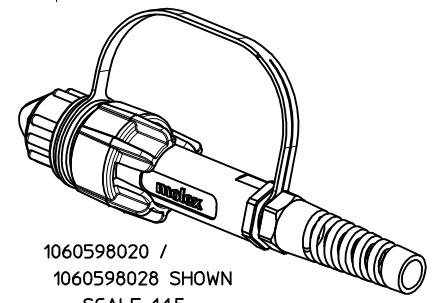
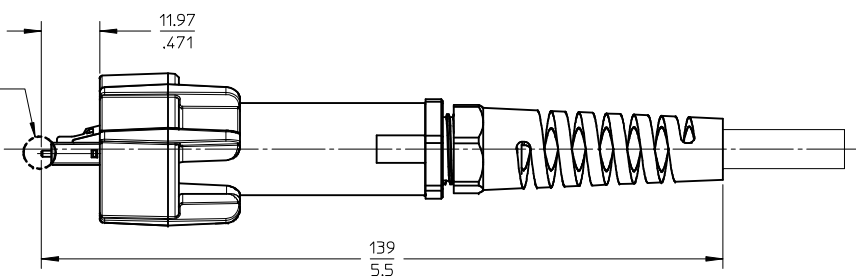

1060598020 /
1060598028 SHOWN
SCALE 1:1.5

- NOTES:
- DIMENSIONS ARE FOR REFERENCE ONLY.
 - DUST CAP AND TETHER SHOWN IN ISO VIEW ONLY.
 - CONNECTOR SUPPORTS CABLES FROM 4 TO 8mm IN DIAMETER.
 - 1060598000 / 1060598008 SHOWN UNLESS OTHERWISE NOTED.
 - 1060598016 / 1060598017 SUPPLIED WITHOUT LC CONNECTORS.

ENTER DESCRIPTION EC NO: MF2013-0735 DRAWN: AECKHART 2013/05/29 CHKD: SERNST 2013/05/31 APPR: WCHEN 2013/06/11 REV A	QUALITY SYMBOLS ▽=0 ▽=0 ▽=0	GENERAL TOLERANCES (UNLESS SPECIFIED)		DIMENSION STYLE MM/IN		SCALE 1:1	DESIGN UNITS METRIC	THIRD ANGLE PROJECTION		
		4 PLACES	± ---	± ---	DRAWN BY	DATE	INDUSTRIAL LC CONNECTOR METAL BODY			
		3 PLACES	± ---	± ---	AECKHART	2013/05/29				
		2 PLACES	± ---	± ---	CHECKED BY	DATE	molex			
1 PLACE	± ---	± ---	SERNST	2013/05/31						
0 PLACE	± ---	± ---	APPROVED BY	DATE	MATERIAL NO. SEE TABLE		DOCUMENT NO. SD-106059-8000		SHEET NO. 1 OF 1	
ANGULAR ± --- °		THIS DRAWING CONTAINS INFORMATION THAT IS PROPRIETARY TO MOLEX INCORPORATED AND SHOULD NOT BE USED WITHOUT WRITTEN PERMISSION								