

HIGH VOLTAGE $I_o = 500$ mA LDO REGULATOR

■ FEATURES

- Fast transient response
- Wide operating voltage
- Wide operating temperature
- High-accuracy output voltage
- Output current
- ON/OFF control
- Ceramic capacitor compatible
- Undervoltage lockout
- Thermal shutdown
- Overcurrent protection
- Package

4.0 V to 40 V
 $T_a = -40^\circ\text{C}$ to 125°C
 $V_o \pm 1.0\%$ ($T_a = 25^\circ\text{C}$)
 500 mA (min)

TO-252-5-L5

■ APPLICATIONS

- Car infotainment
- Industrial equipment
- Consumer appliances

■ DESCRIPTION

The NJW4105 is a 45 V, $I_o = 500$ mA fast transient response low dropout regulator. This device achieves fast transient response and offers stable output voltage even at line or load fluctuations.

The NJW4105 provides outstanding high output voltage accuracy that guaranteed $\pm 1.0\%$ under the conditions of $V_{IN} = V_o + 1$ V to 40 V, $I_o = 0$ mA to 500 mA.

Moreover, wide operating voltage and wide operating temperature make the NJW4105 ideal for automotive accessories or applications that require high reliability.

■ TYPICAL APPLICATION

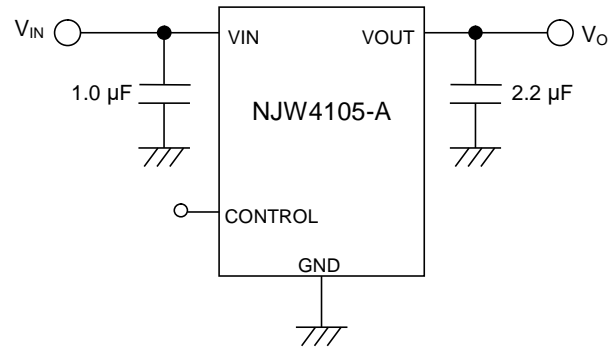

■ BLOCK DIAGRAM

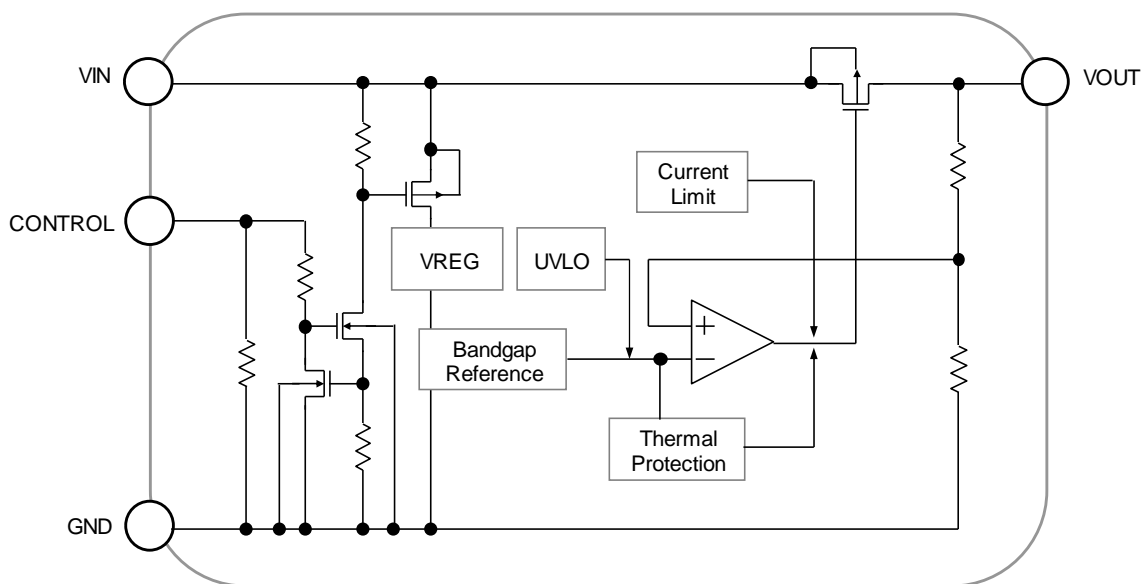

■ OUTPUT VOLTAGE RANK

PRODUCT NAME	OUTPUT VOLTAGE
NJW4105DL5-33A	3.3 V
NJW4105DL5-05A	5.0 V
NJW4105DL5-08A	8.0 V

■ PIN CONFIGURATION

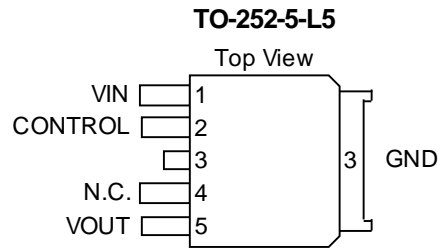

PIN NO.	NAME	FUNCTION
1	VIN	Input pin
2	CONTROL	ON/OFF control pin
3	GND	Ground pin
4	N.C.	Not internally connected*
5	VOUT	Output pin

*This pin is not internally connected. Connect to ground or leave floating (open). Connect to ground to improve thermal dissipation.

■ PRODUCT NAME INFORMATION

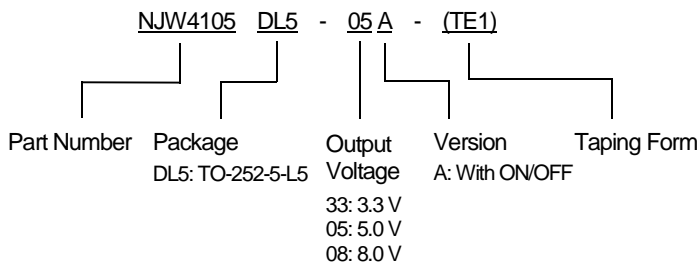

■ ORDERING INFORMATION

PRODUCT NAME	PACKAGE	RoHS	HALOGEN-FREE	TERMINAL FINISH	MARKING	WEIGHT (mg)	MOQ (pcs)
NJW4105DL5-33A (TE1)	TO-252-5-L5	Yes	Yes	Sn-2Bi	105A33	301	3000
NJW4105DL5-05A (TE1)	TO-252-5-L5	Yes	Yes	Sn-2Bi	105A05	301	3000
NJW4105DL5-08A (TE1)	TO-252-5-L5	Yes	Yes	Sn-2Bi	105A08	301	3000

■ ABSOLUTE MAXIMUM RATINGS

PARAMETER	SYMBOL	RATING	UNIT
Input Voltage	V_{IN}	-0.3 to 45	V
Control Voltage	V_{CONT}	-0.3 to 45	V
Output Voltage	V_O	-0.3 to $V_{IN} \leq +17$ ⁽¹⁾	V
Power Dissipation ($T_a = 25^\circ\text{C}$) TO-252-5-L5	P_D	2-Layer / 4-Layer / High Power 4-Layer 870 ⁽²⁾ / 3000 ⁽³⁾ / 4700 ⁽⁴⁾	mW
Junction Temperature	T_j	-40 to 150	$^\circ\text{C}$
Storage Temperature	T_{stg}	-50 to 150	$^\circ\text{C}$

(1) When the input voltage is less than 17 V, the absolute maximum output voltage is equal to the input voltage. If the input voltage is below 17 V, the maximum output voltage is 17 V.

(2) 2-Layer: Mounted on glass epoxy board (76.2 mm × 114.3 mm × 1.6 mm: based on EIA/JEDEC standard, 2-layer FR-4).

(3) 4-Layer: Mounted on glass epoxy board (76.2 mm × 114.3 mm × 1.6 mm: based on EIA/JEDEC standard, 4-layer FR-4).

(For 4-layer: Applying 74.2 mm × 74.2 mm inner Cu area and a thermal via hole to a board based on JEDEC standard JESD51-5.)

(4) High Power 4-Layer: Mounted on glass epoxy board (76.2 mm × 114.3 mm × 1.6 mm, 4-layer FR-4).

(For 4-layer: Applying 74.2 mm × 74.2 mm inner Cu area and a thermal via hole to a board based on JEDEC standard JESD51-5.)

*For the specifications of each board, see the Board Specifications of THERMAL CHARACTERISTICS.

■ RECOMMENDED OPERATING CONDITIONS

PARAMETER	SYMBOL	VALUE	UNIT
Operating Voltage	V_{IN}	4.0 to 40	V
Control Voltage	V_{CONT}	0 to 40	V
Output Current	I_o	0 to 500	mA
Operating Temperature	T_{opr}	-40 to 125	$^\circ\text{C}$

■ ELECTRICAL CHARACTERISTICS

$V_{IN} = V_O + 1\text{ V}$, $C_{IN} = 1.0\ \mu\text{F}$, $C_O = 2.2\ \mu\text{F}$, $T_a = 25^\circ\text{C}$, unless otherwise noted.

PARAMETER	SYMBOL	TEST CONDITIONS	MIN	TYP	MAX	UNIT	
Output Voltage	V_O	$V_{IN} = V_O + 1\text{ V}$ to 40 V, $I_O = 0\text{ mA}$ to 500 mA	-1.0%	-	+1.0%	V	
Quiescent Current	I_Q	$I_O = 0\text{ mA}$, except I_{CONT}	-	65	105	μA	
Quiescent Current at Control OFF	$I_{Q(OFF)}$	$V_{CONT} = 0\text{ V}$	-	-	1	μA	
Output Current	I_O	$V_O \times 0.9$	500	-	-	mA	
Line Regulation	$\Delta V_O / \Delta V_{IN}$	$V_{IN} = V_O + 1\text{ V}$ to 40 V, $I_O = 30\text{ mA}$	$V_O = 3.3\text{ V}$	-	-	23.5	mV
			$V_O = 5.0\text{ V}$	-	-	34.0	
			$V_O = 8.0\text{ V}$	-	-	52.5	
Load Regulation	$\Delta V_O / \Delta I_O$	$I_O = 0\text{ mA}$ to 500 mA	$V_O = 3.3\text{ V}$	-	-	18.5	mV
			$V_O = 5.0\text{ V}$	-	-	22.5	
			$V_O = 8.0\text{ V}$	-	-	36.0	
Ripple Rejection	RR	$V_{IN} = V_O + 1\text{ V}$, $e_{in} = 200\text{ mVrms}$, $f = 1\text{ kHz}$, $I_O = 10\text{ mA}$	$V_O = 3.3\text{ V}$	-	56	-	dB
			$V_O = 5.0\text{ V}$	-	53	-	
			$V_O = 8.0\text{ V}$	-	50	-	
Dropout Voltage 1 ⁽⁵⁾	ΔV_{IO1}	$I_O = 300\text{ mA}$	-	0.24	0.42	V	
Dropout Voltage 2 ⁽⁵⁾	ΔV_{IO2}	$I_O = 500\text{ mA}$	-	0.40	0.70	V	
Control Current	I_{CONT}	$V_{CONT} = 1.6\text{ V}$	-	0.5	2.0	μA	
Control Voltage for ON-State	$V_{CONT(ON)}$		1.6	-	-	V	
Control Voltage for OFF-State	$V_{CONT(OFF)}$		-	-	0.6	V	
UVLO Release Voltage	V_{UVLO}	$V_{IN} = \text{low to high}$	2.3	2.7	3.1	V	
UVLO Hysteresis Voltage	V_{HYS}	$V_{IN} = \text{high to low}$	200	500	-	mV	
Average Temperature Coefficient of Output Voltage	$\Delta V_O / \Delta T_a$	$T_a = -40^\circ\text{C}$ to 125°C , $I_O = 30\text{ mA}$	-	± 50	-	ppm/ $^\circ\text{C}$	

(5) Output voltages below 3.8 V are excluded.

■ THERMAL CHARACTERISTICS

PARAMETER	SYMBOL	VALUE	UNIT
Junction-To-Ambient Thermal Resistance TO-252-5-L5	θ_{ja}	2-Layer / 4-Layer / High Power 4-Layer 143 ⁽⁶⁾ / 41 ⁽⁷⁾ / 26 ⁽⁸⁾	°CW
Junction-To-Top of Package Characterization Parameter TO-252-5-L5	ψ_{jt}	2-Layer / 4-Layer / High Power 4-Layer 30 ⁽⁶⁾ / 15 ⁽⁷⁾ / 11 ⁽⁸⁾	°CW

■ BOARD SPECIFICATIONS

BOARD		JEDEC 2-LAYER BOARD	JEDEC 4-LAYER BOARD	HIGH POWER 4-LAYER BOARD
Dimension		76.2 mm × 114.3 mm, t = 1.6 mm		
Material		FR-4		
Cu Area	Surface Layer (Thickness: 70 μm)	NJR recommended land pattern + Measurement wiring	NJR recommended land pattern + Measurement wiring	NJR recommended land pattern + Heat dissipation pattern (50 mm × 50 mm) + Measurement wiring
	2 nd Layer (Thickness: 35 μm)	-	74.2 mm × 74.2 mm	74.2 mm × 74.2 mm
	3 rd Layer (Thickness: 35 μm)	-	74.2 mm × 74.2 mm	74.2 mm × 74.2 mm
	Back Layer (Thickness: 70 μm)	-	-	74.2 mm × 74.2 mm
Thermal Vias		-	Connected from surface layer to 2 nd layer	All layers are connected

■ POWER DISSIPATION vs. AMBIENT TEMPERATURE

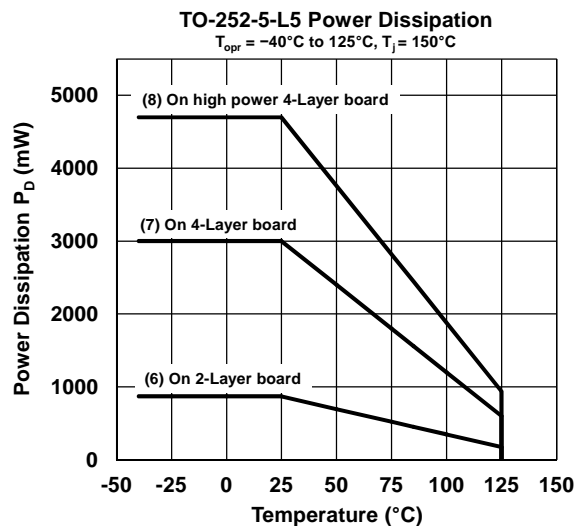

- (6) 2-Layer: Mounted on glass epoxy board (76.2 mm × 114.3 mm × 1.6 mm: based on EIA/JEDEC standard, 2-layer FR-4).
- (7) 4-Layer: Mounted on glass epoxy board (76.2 mm × 114.3 mm × 1.6 mm: based on EIA/JEDEC standard, 4-layer FR-4).
(For 4-layer: Applying 74.2 mm × 74.2 mm inner Cu area and a thermal via hole to a board based on JEDEC standard JESD51-5.)
- (8) High Power 4-Layer: Mounted on glass epoxy board (76.2 mm × 114.3 mm × 1.6 mm, 4-layer FR-4).
(For 4-layer: Applying 74.2 mm × 74.2 mm inner Cu area and a thermal via hole to a board based on JEDEC standard JESD51-5.)

■ TYPICAL CHARACTERISTICS ($V_O = 3.3\text{ V}$)

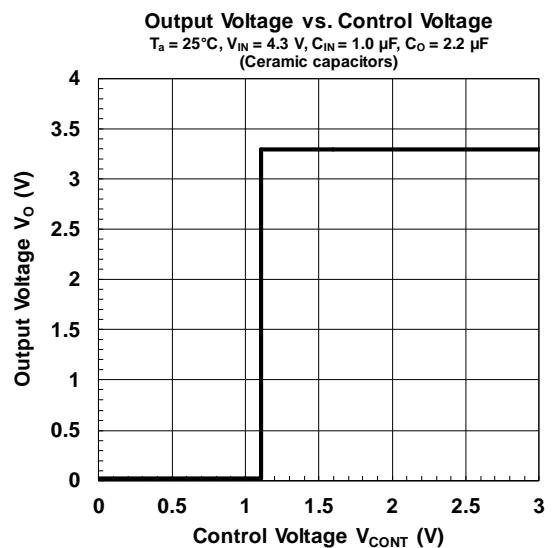
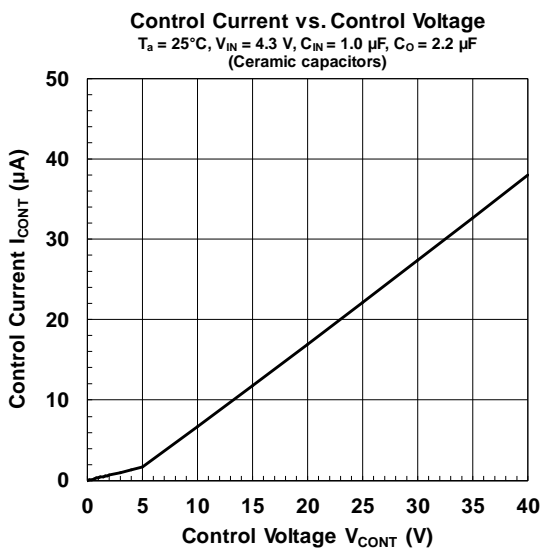
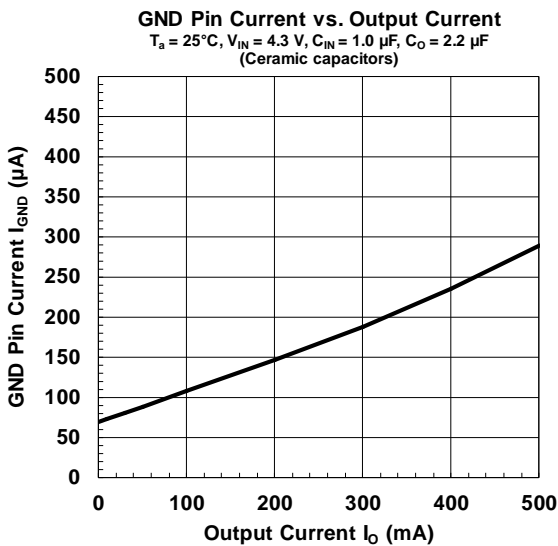
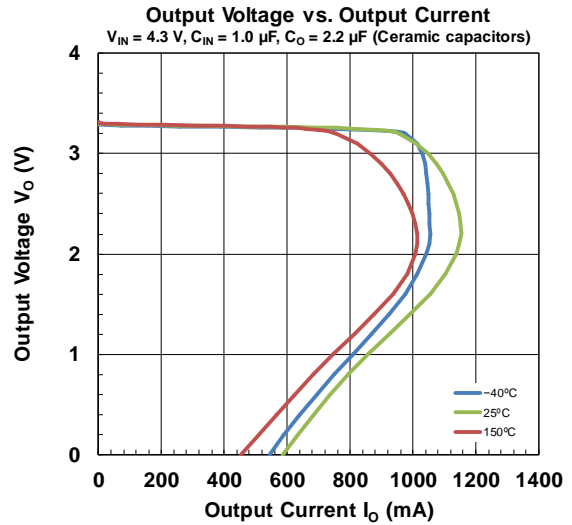
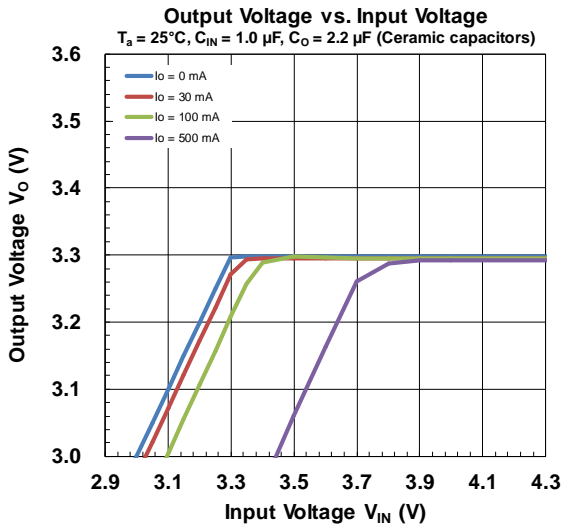

■ TYPICAL CHARACTERISTICS ($V_O = 3.3\text{ V}$)

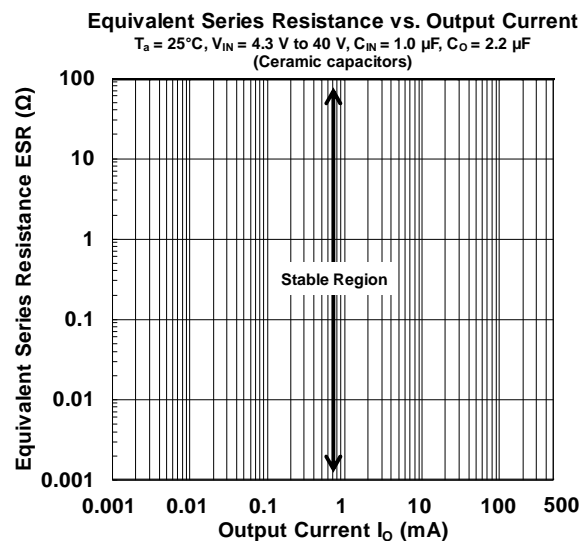
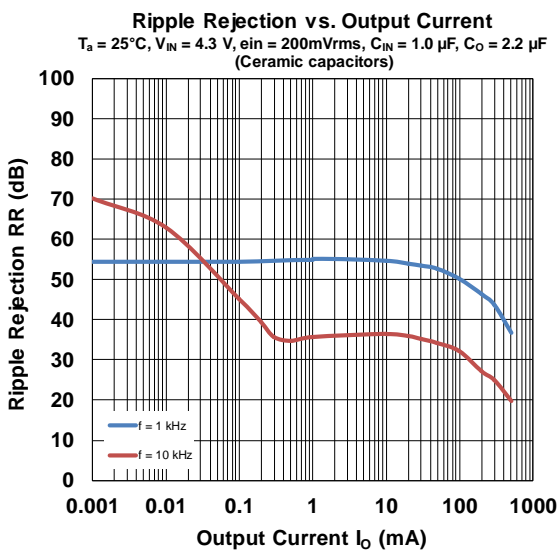
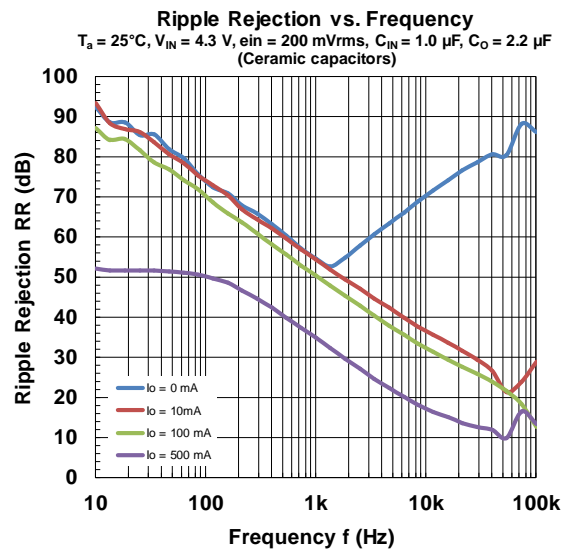
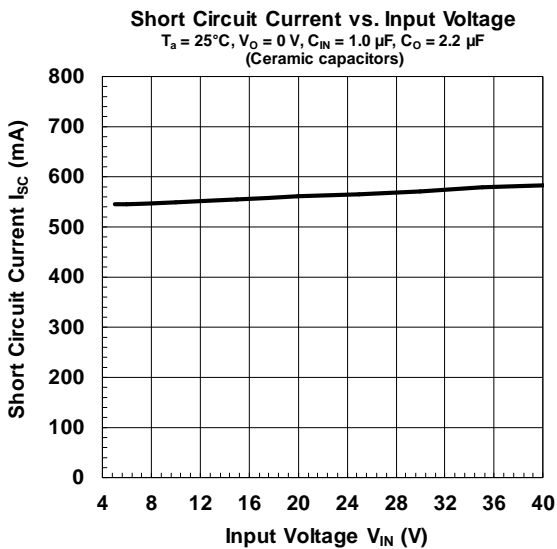
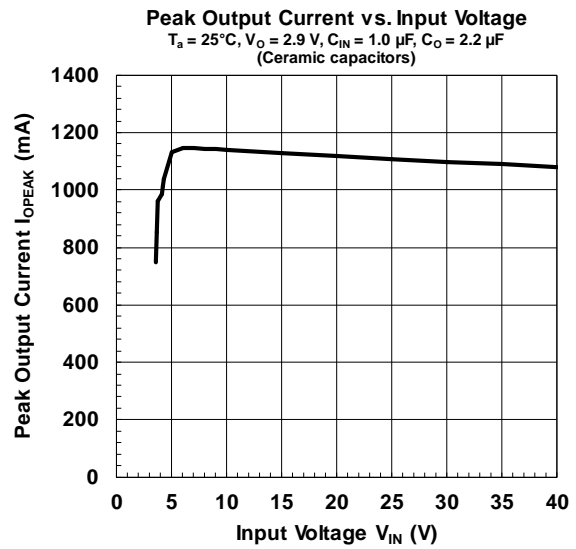
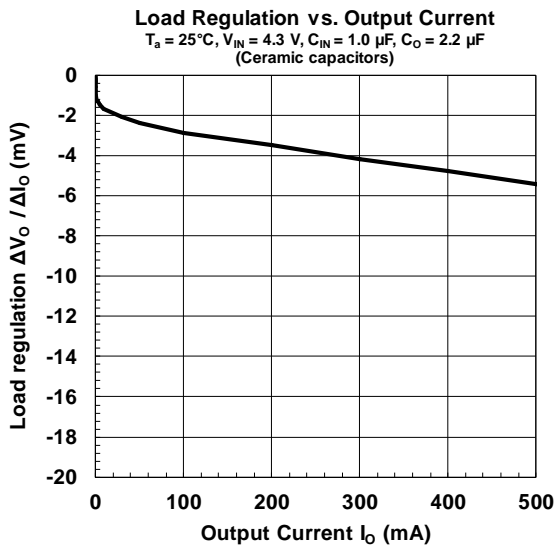

■ TYPICAL CHARACTERISTICS ($V_O = 3.3\text{ V}$)

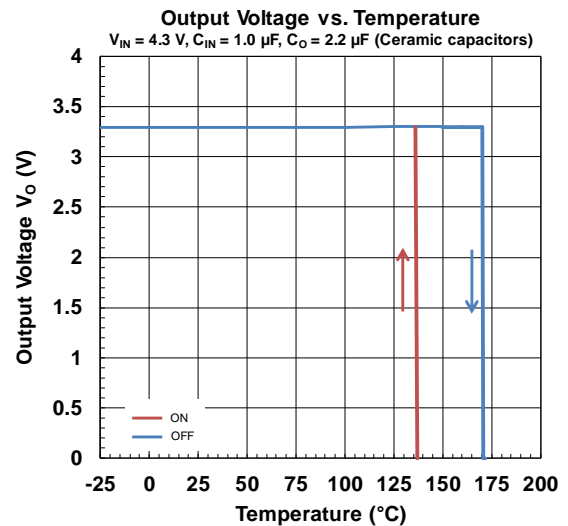
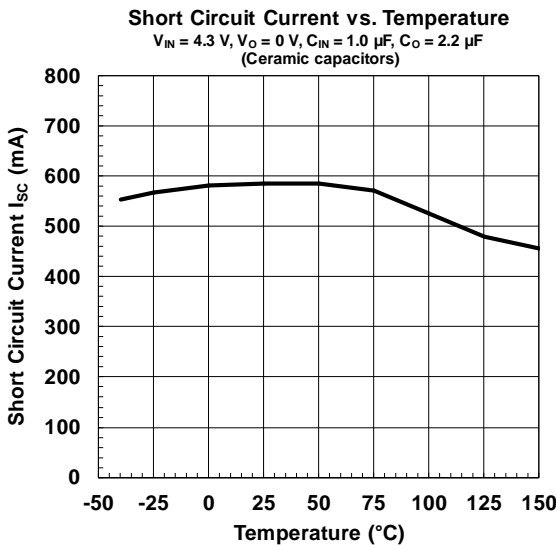
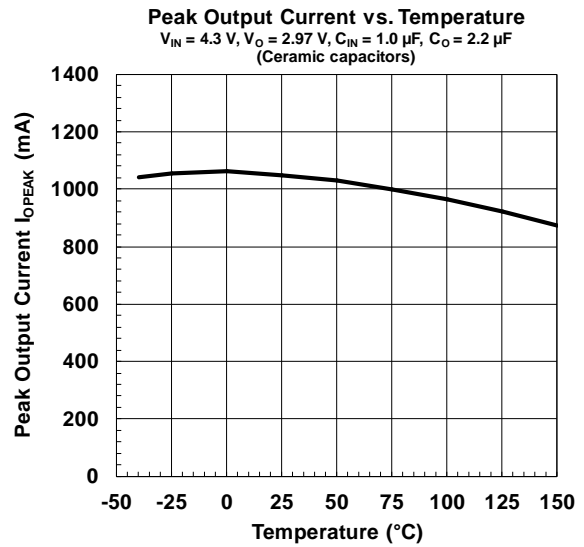
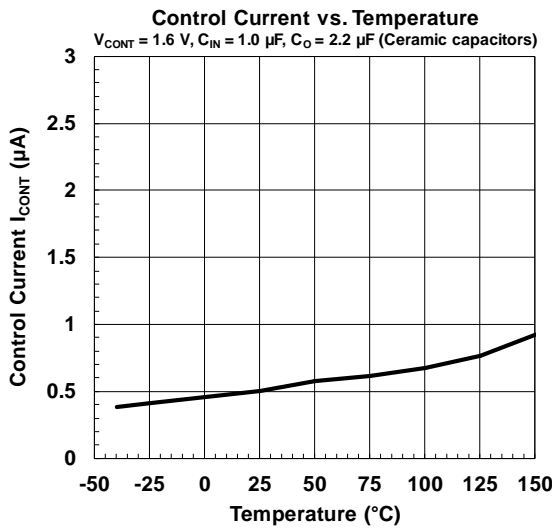
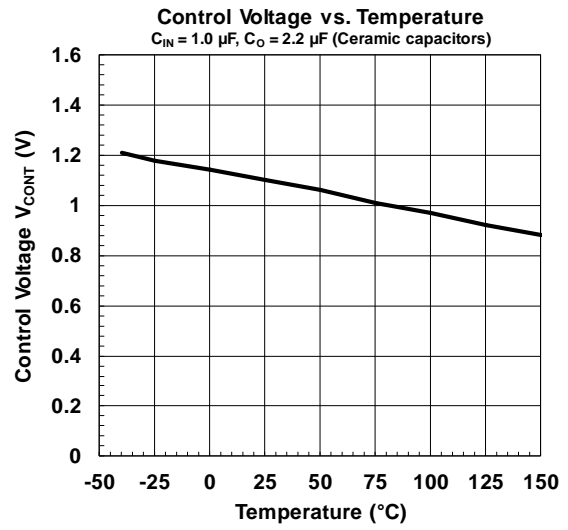
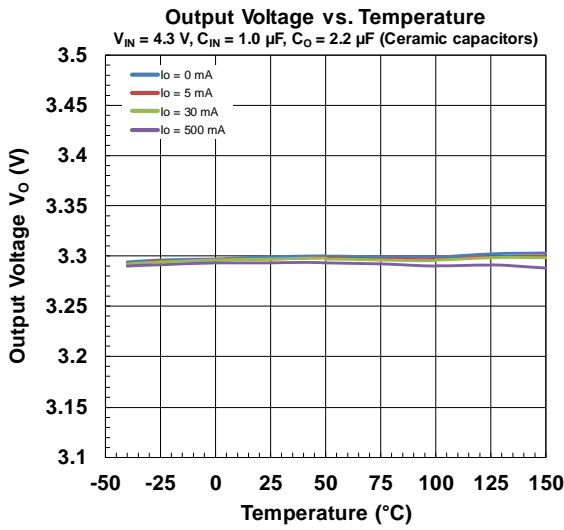

■ TYPICAL CHARACTERISTICS ($V_o = 3.3\text{ V}$)

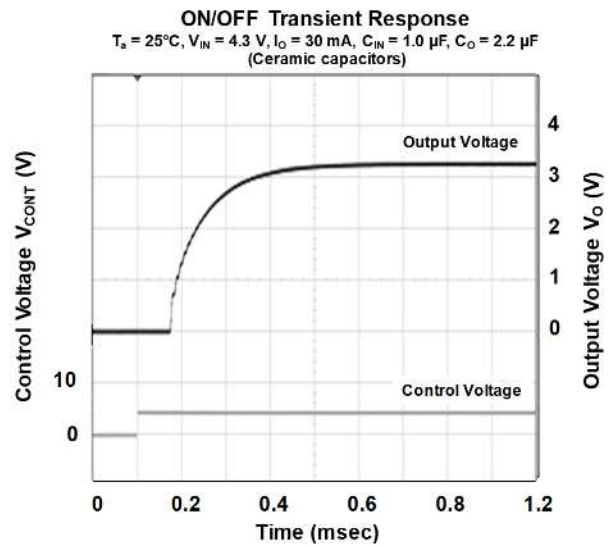
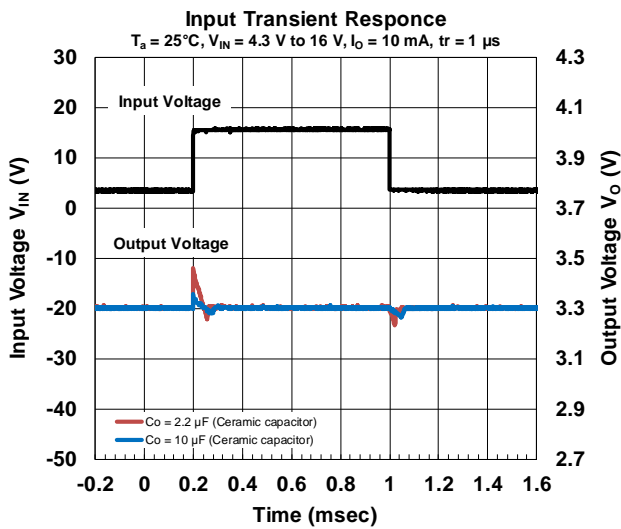
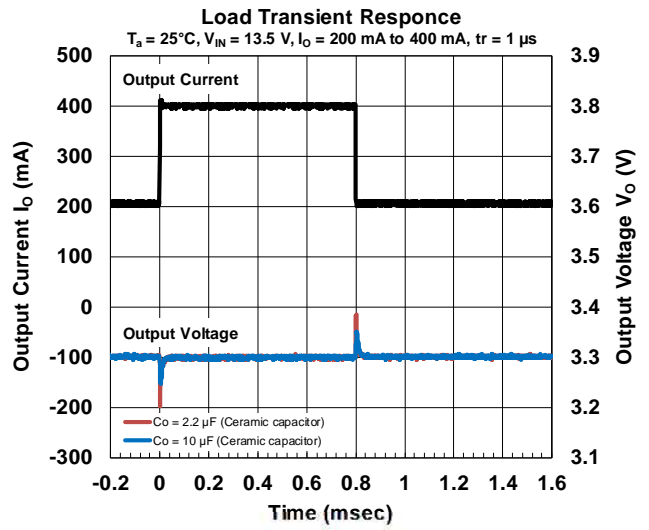
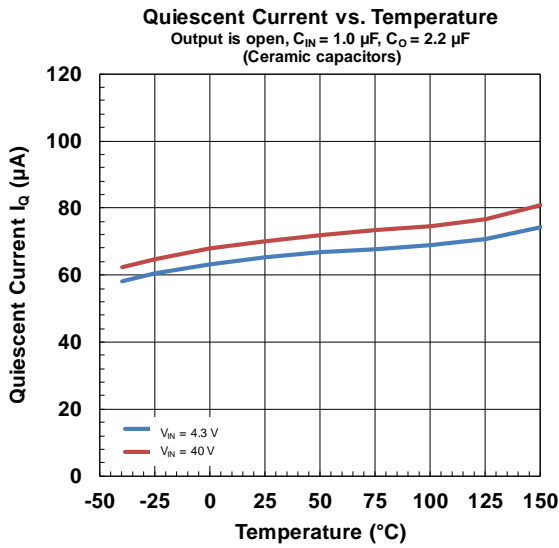

■ TYPICAL CHARACTERISTICS ($V_O = 5\text{ V}$)

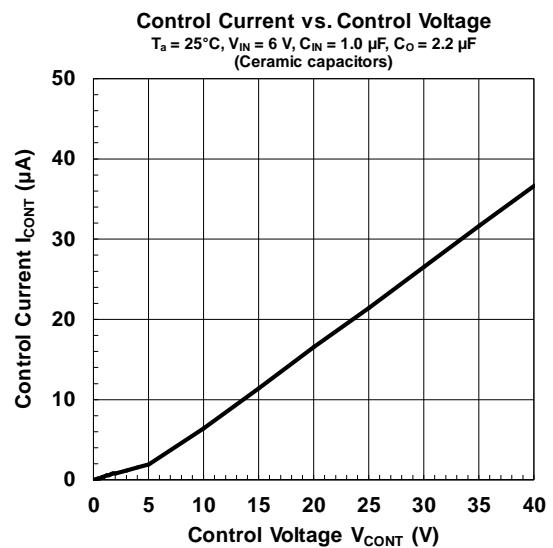
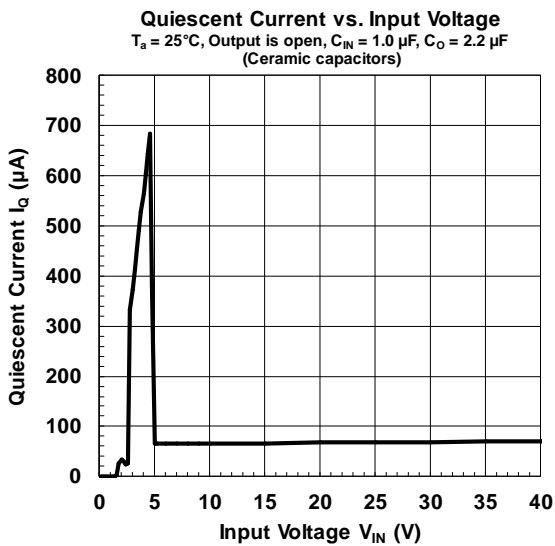
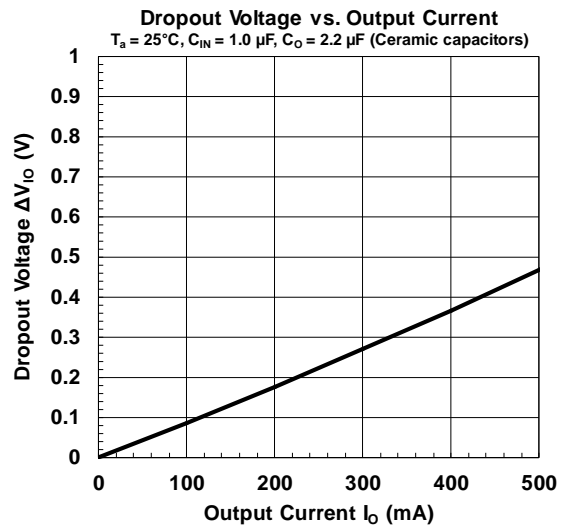
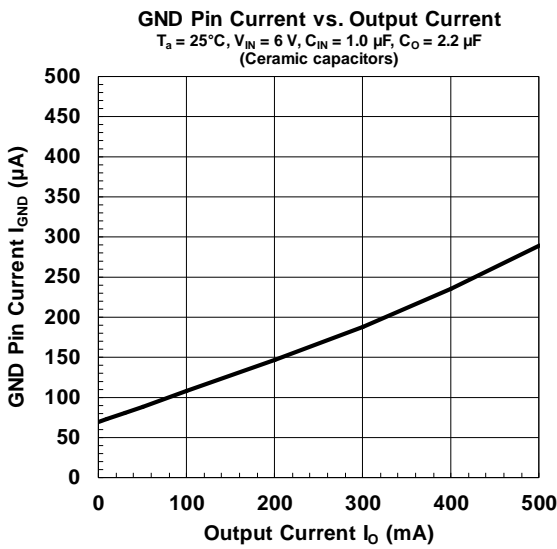
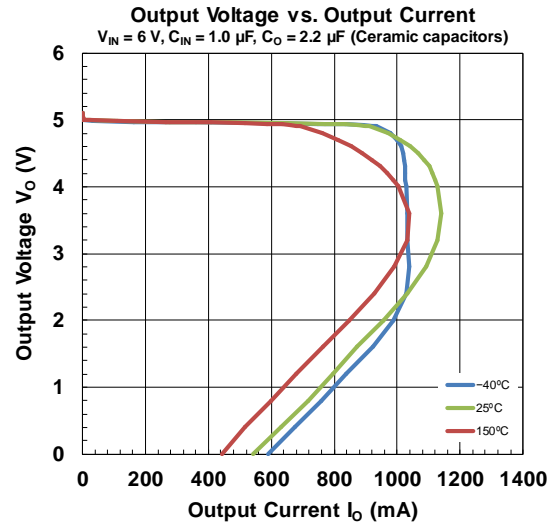
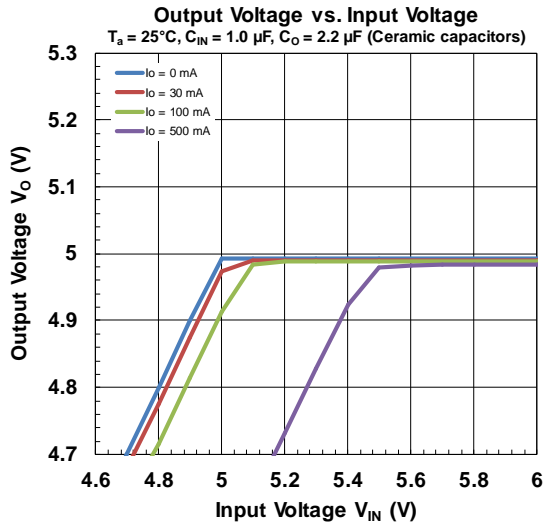

■ TYPICAL CHARACTERISTICS ($V_O = 5\text{ V}$)

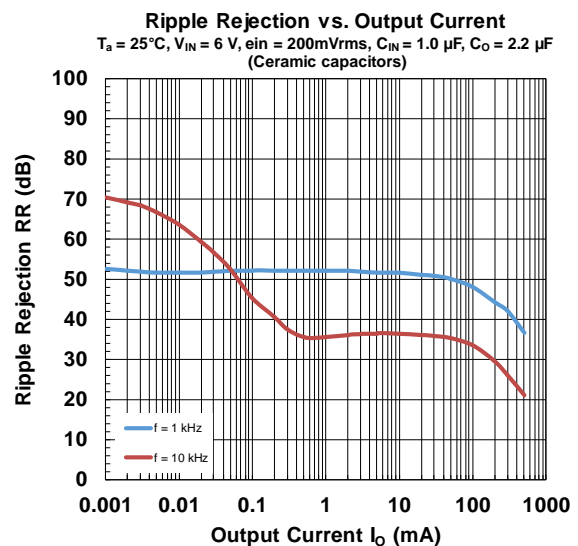
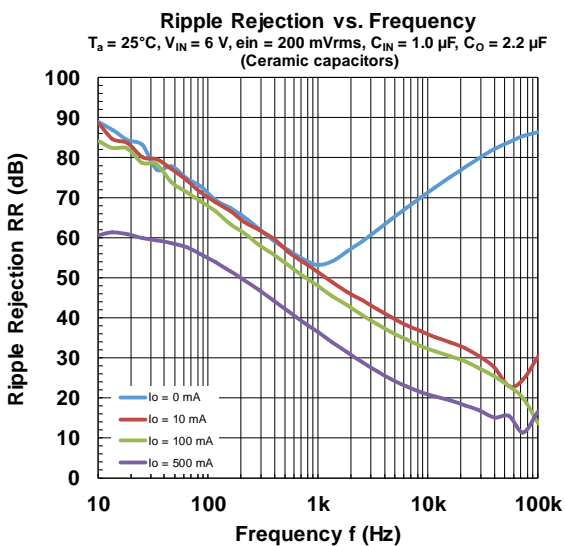
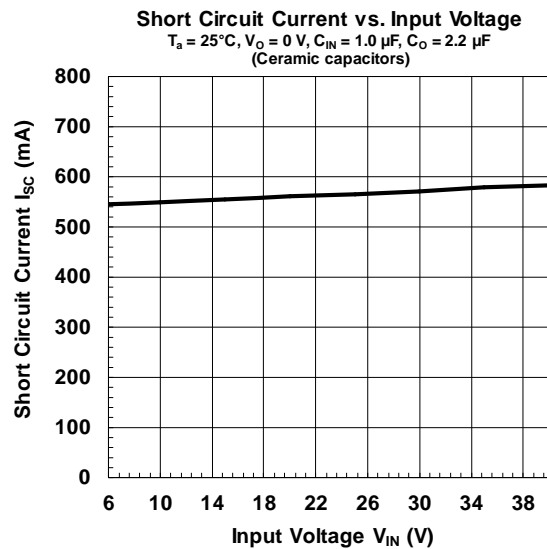
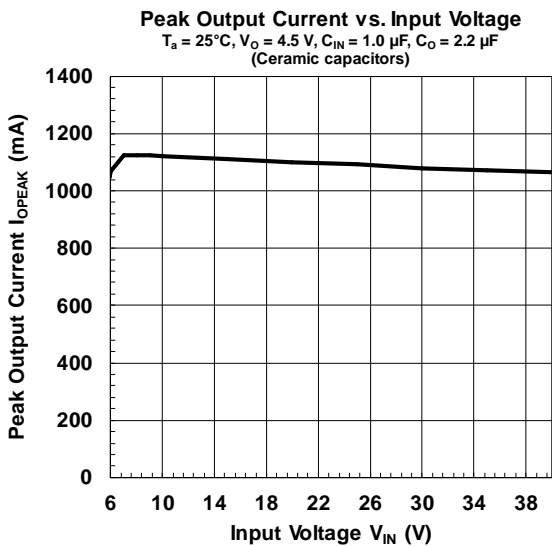
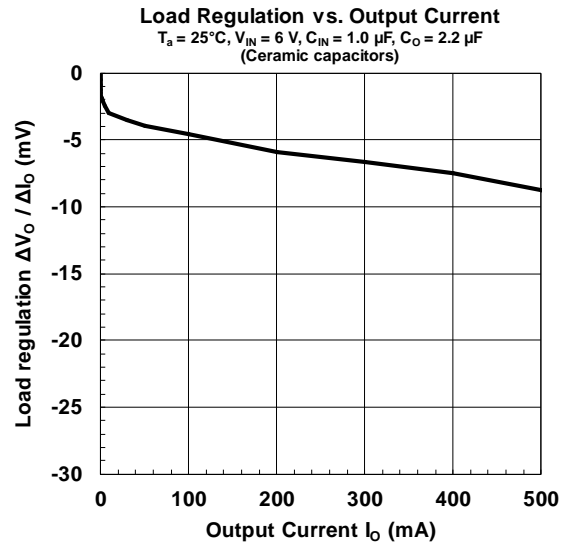
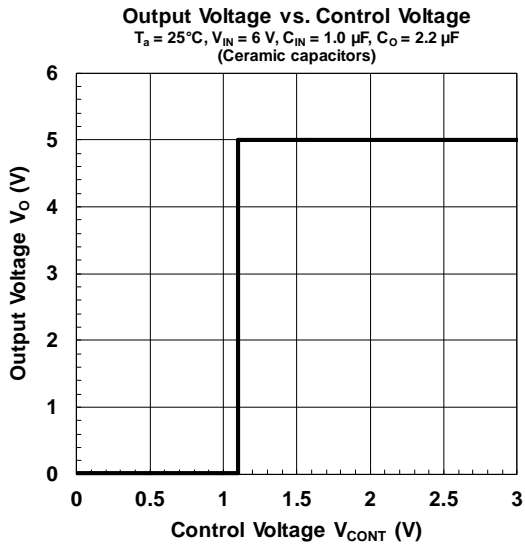

■ TYPICAL CHARACTERISTICS ($V_O = 5\text{ V}$)

Equivalent Series Resistance vs. Output Current
 $T_a = 25^\circ\text{C}$, $V_{IN} = 6\text{ V to } 40\text{ V}$, $C_{IN} = 1.0\ \mu\text{F}$, $C_O = 2.2\ \mu\text{F}$
 (Ceramic capacitors)

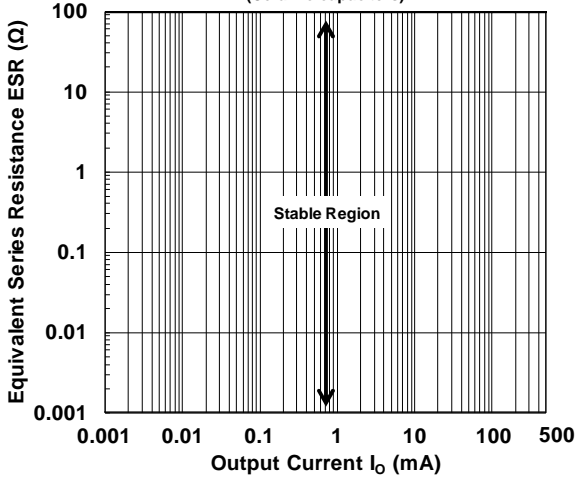

Output Voltage vs. Temperature
 $V_{IN} = 6\text{ V}$, $C_{IN} = 1.0\ \mu\text{F}$, $C_O = 2.2\ \mu\text{F}$ (Ceramic capacitors)

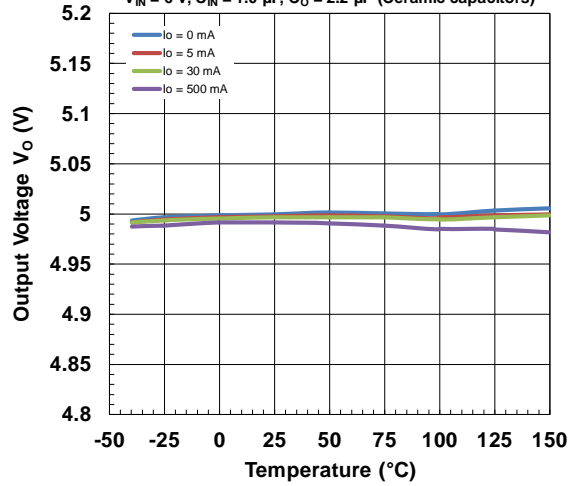

Control Voltage vs. Temperature
 $C_{IN} = 1.0\ \mu\text{F}$, $C_O = 2.2\ \mu\text{F}$ (Ceramic capacitors)

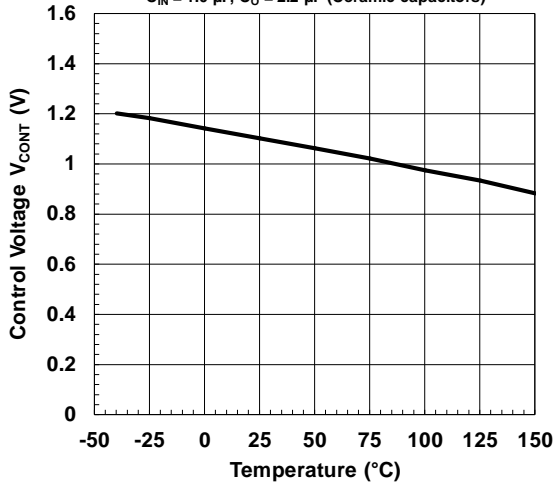

Control Current vs. Temperature
 $V_{CONT} = 1.6\text{ V}$, $C_{IN} = 1.0\ \mu\text{F}$, $C_O = 2.2\ \mu\text{F}$ (Ceramic capacitors)

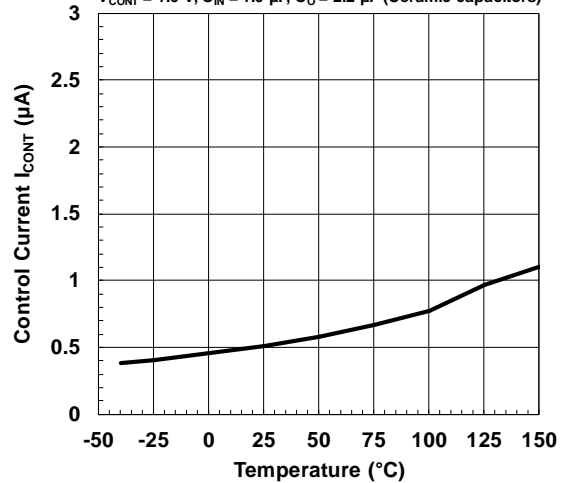

Peak Output Current vs. Temperature
 $V_{IN} = 6\text{ V}$, $V_O = 4.5\text{ V}$, $C_{IN} = 1.0\ \mu\text{F}$, $C_O = 2.2\ \mu\text{F}$
 (Ceramic capacitors)

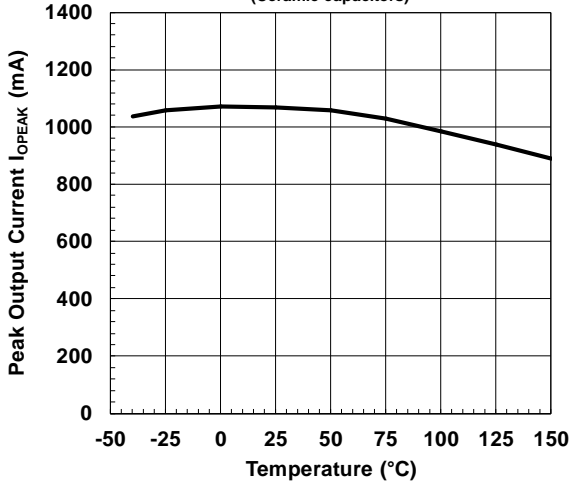

Short Circuit Current vs. Temperature
 $V_{IN} = 6\text{ V}$, $V_O = 0\text{ V}$, $C_{IN} = 1.0\ \mu\text{F}$, $C_O = 2.2\ \mu\text{F}$
 (Ceramic capacitors)

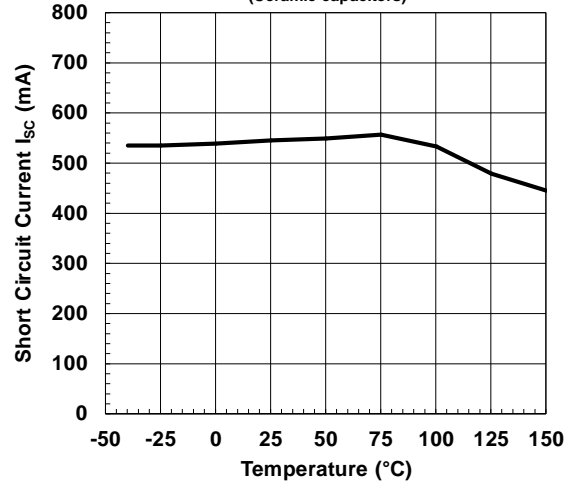

■ TYPICAL CHARACTERISTICS ($V_O = 5\text{ V}$)

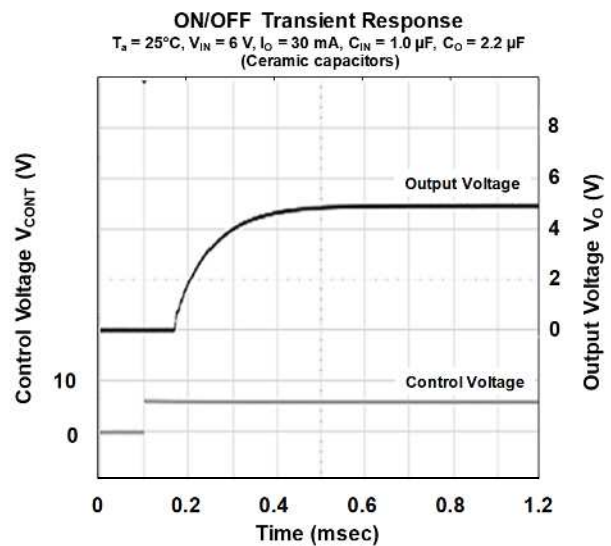
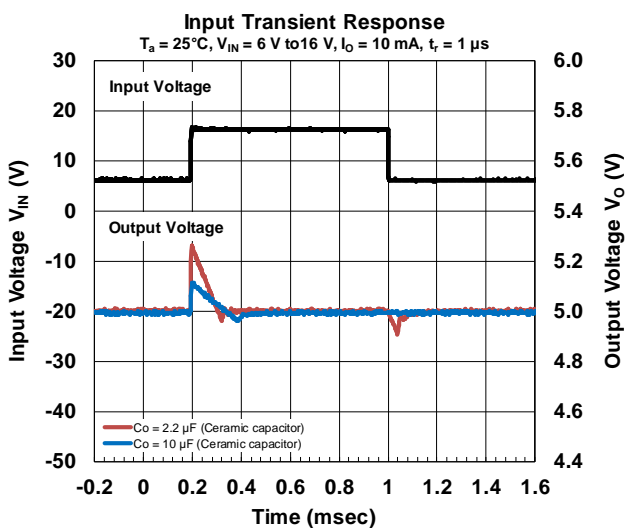
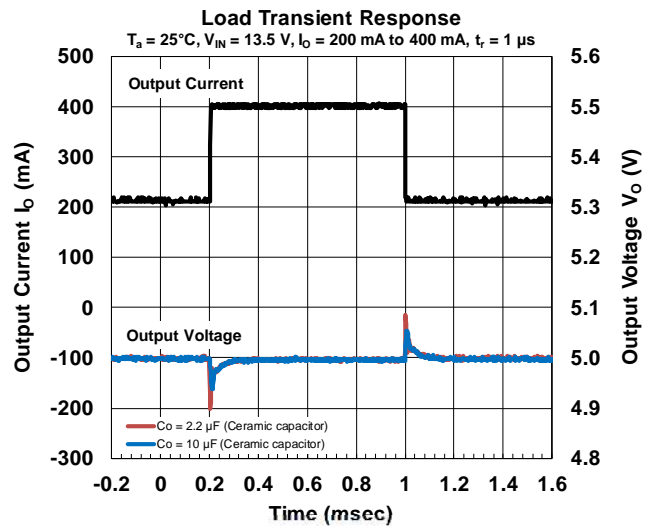
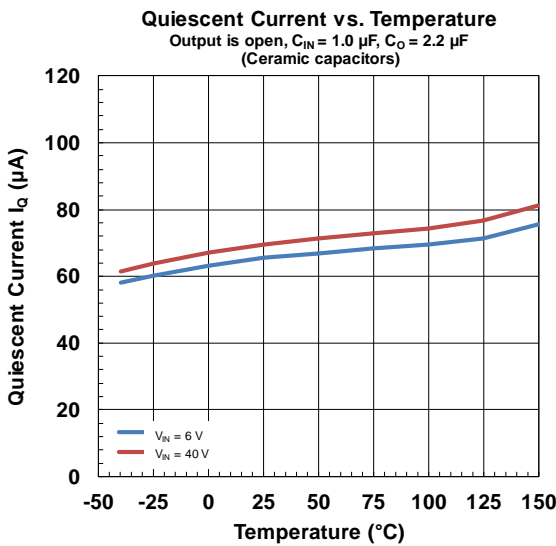
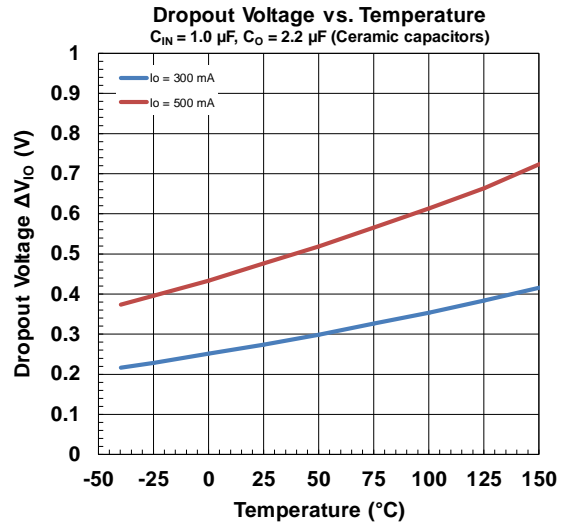
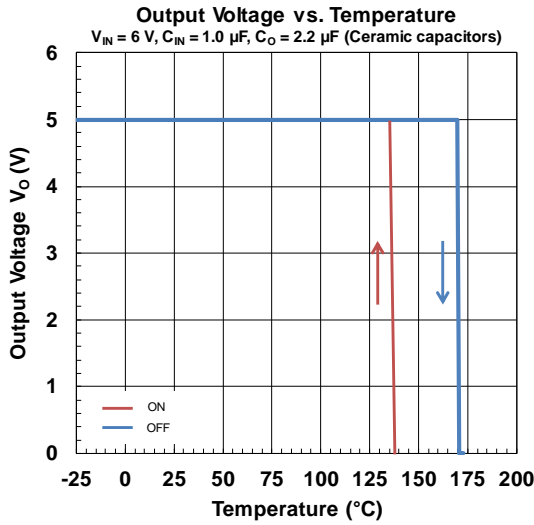

■ TYPICAL CHARACTERISTICS ($V_O = 8\text{ V}$)

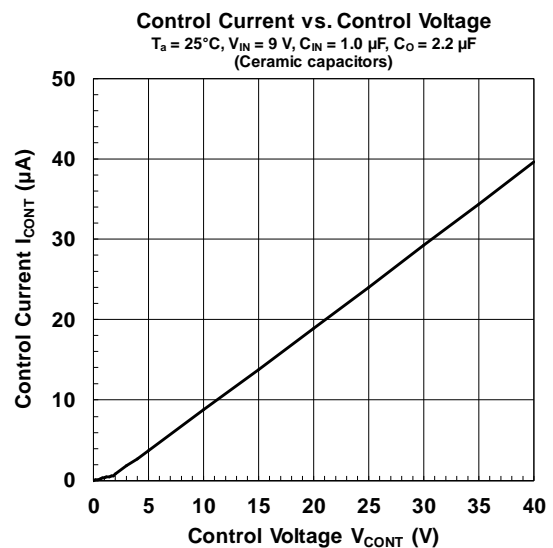
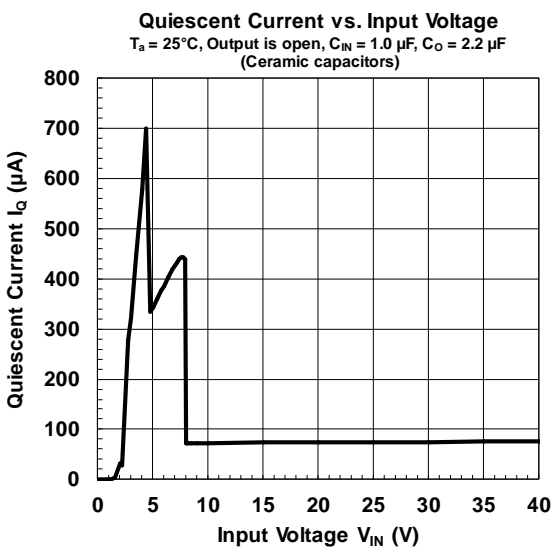
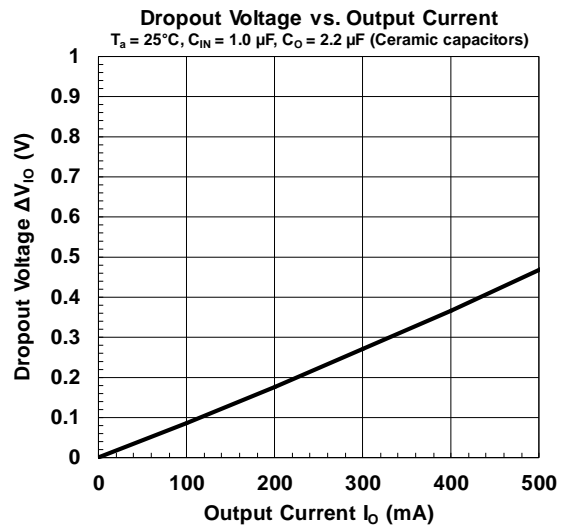
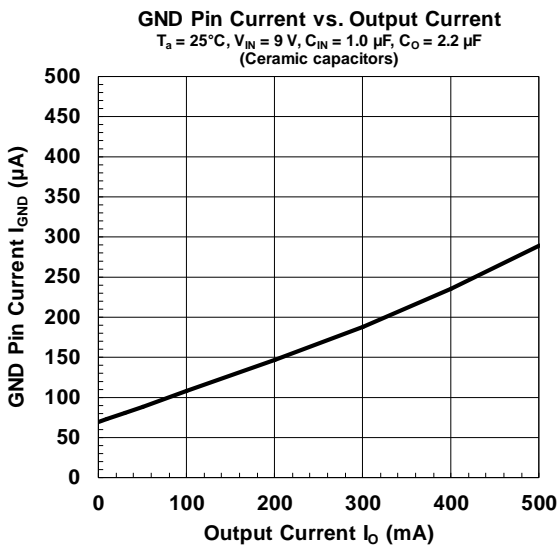
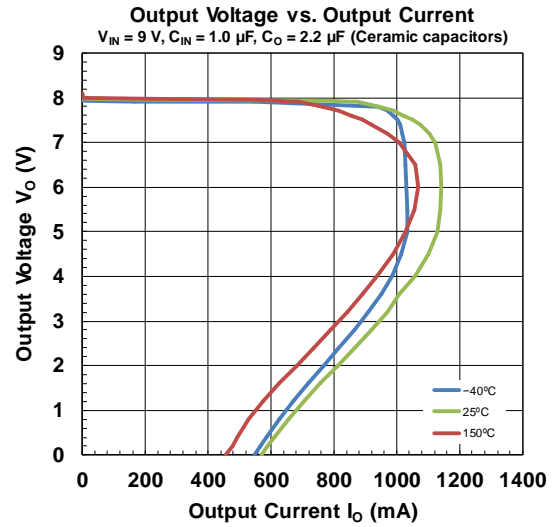
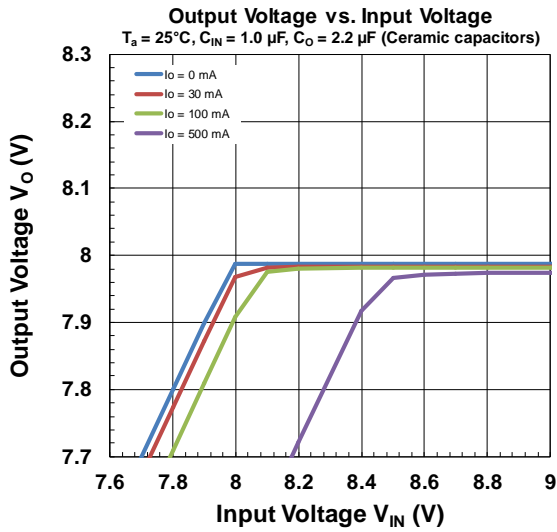

■ TYPICAL CHARACTERISTICS ($V_O = 8\text{ V}$)

Output Voltage vs. Control Voltage
 $T_a = 25^\circ\text{C}$, $V_{IN} = 9\text{ V}$, $C_{IN} = 1.0\ \mu\text{F}$, $C_O = 2.2\ \mu\text{F}$
 (Ceramic capacitors)

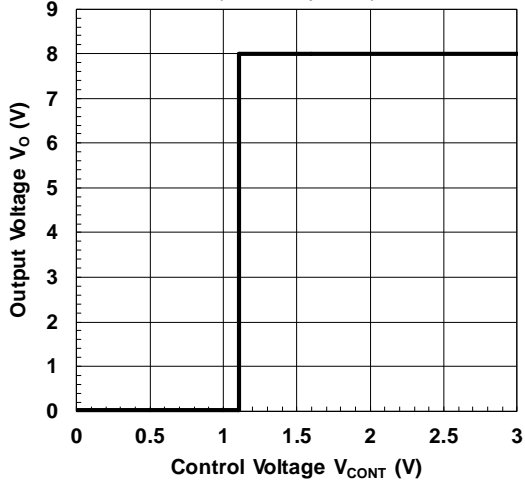

Load Regulation vs. Output Current
 $T_a = 25^\circ\text{C}$, $V_{IN} = 9\text{ V}$, $C_{IN} = 1.0\ \mu\text{F}$, $C_O = 2.2\ \mu\text{F}$
 (Ceramic capacitors)

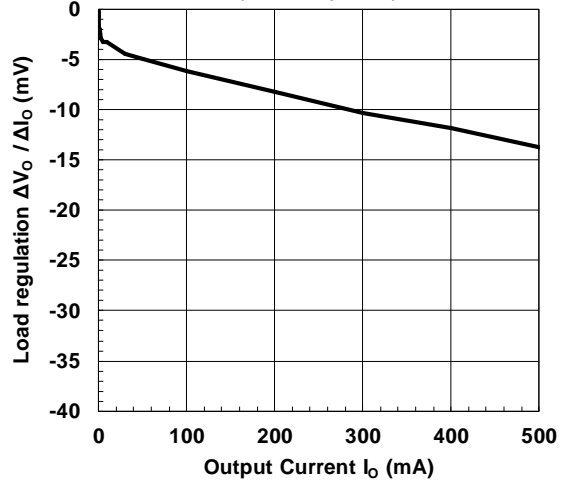

Peak Output Current vs. Input Voltage
 $T_a = 25^\circ\text{C}$, $V_O = 7.2\text{ V}$, $C_{IN} = 1.0\ \mu\text{F}$, $C_O = 2.2\ \mu\text{F}$
 (Ceramic capacitors)

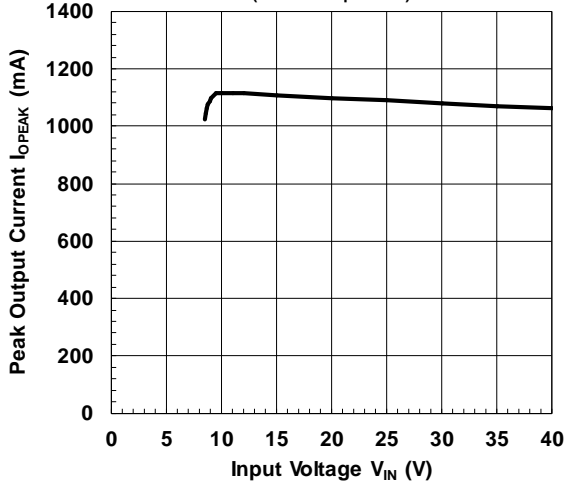

Short Circuit Current vs. Input Voltage
 $T_a = 25^\circ\text{C}$, $V_O = 0\text{ V}$, $C_{IN} = 1.0\ \mu\text{F}$, $C_O = 2.2\ \mu\text{F}$
 (Ceramic capacitors)

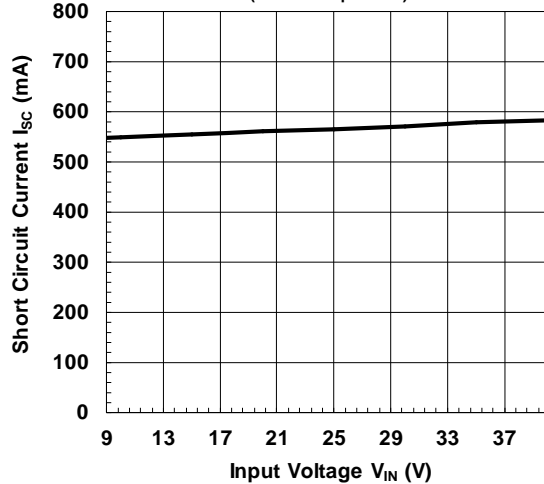

Ripple Rejection vs. Frequency
 $T_a = 25^\circ\text{C}$, $V_{IN} = 9\text{ V}$, $e_{in} = 200\text{ mVrms}$, $C_{IN} = 1.0\ \mu\text{F}$, $C_O = 2.2\ \mu\text{F}$
 (Ceramic capacitors)

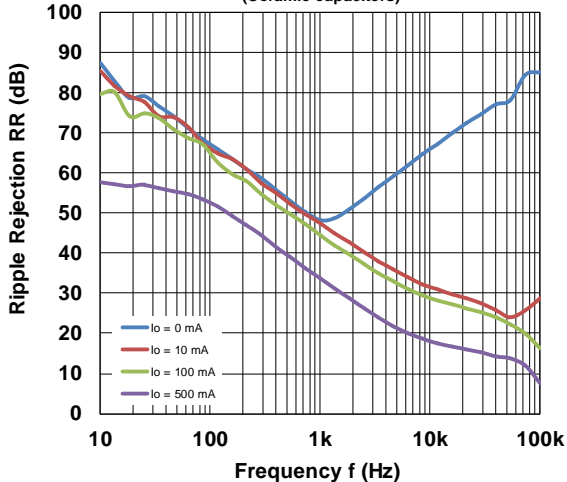

Ripple Rejection vs. Output Current
 $T_a = 25^\circ\text{C}$, $V_{IN} = 9\text{ V}$, $e_{in} = 200\text{ mVrms}$, $C_{IN} = 1.0\ \mu\text{F}$, $C_O = 2.2\ \mu\text{F}$
 (Ceramic capacitors)

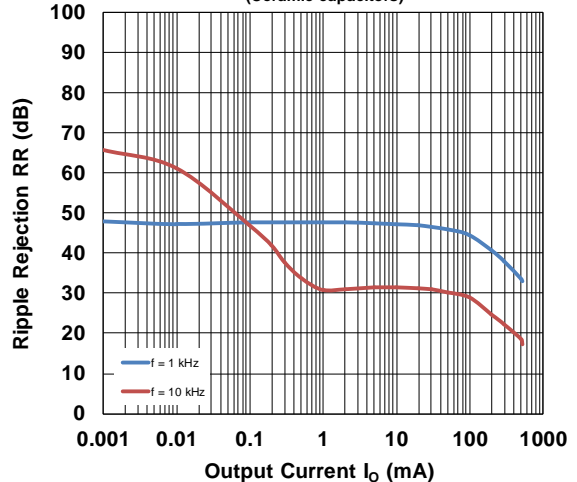

■ TYPICAL CHARACTERISTICS ($V_O = 8\text{ V}$)

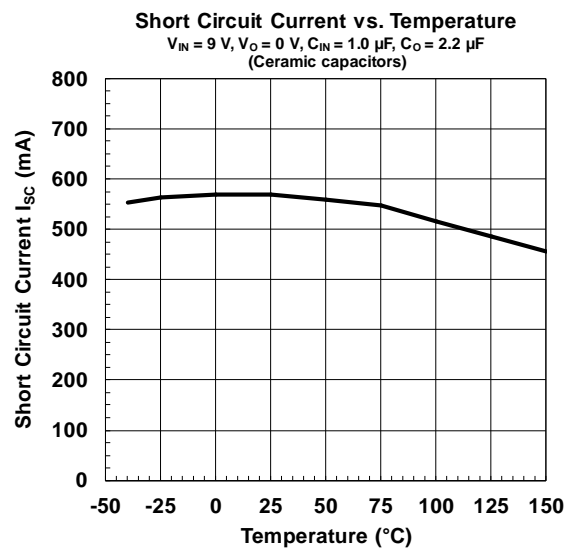
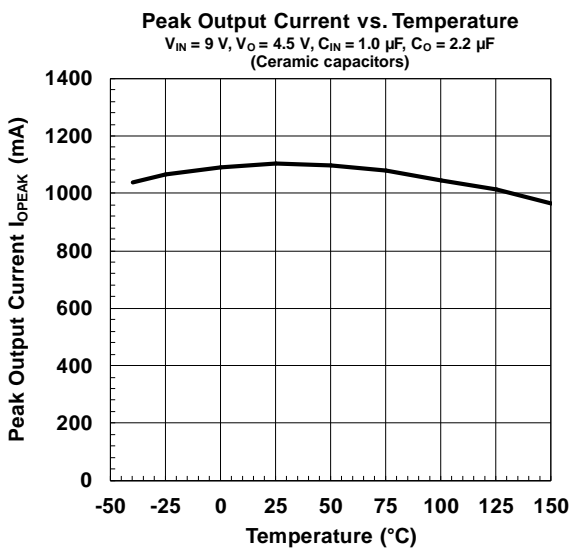
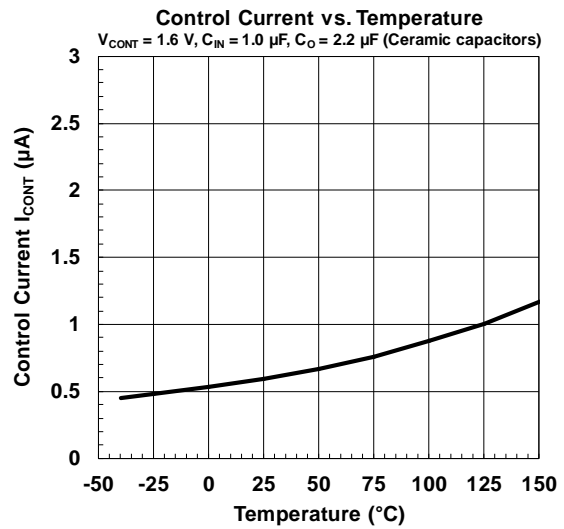
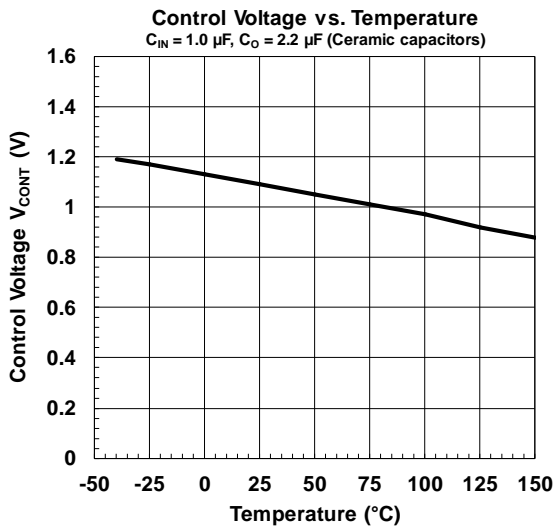
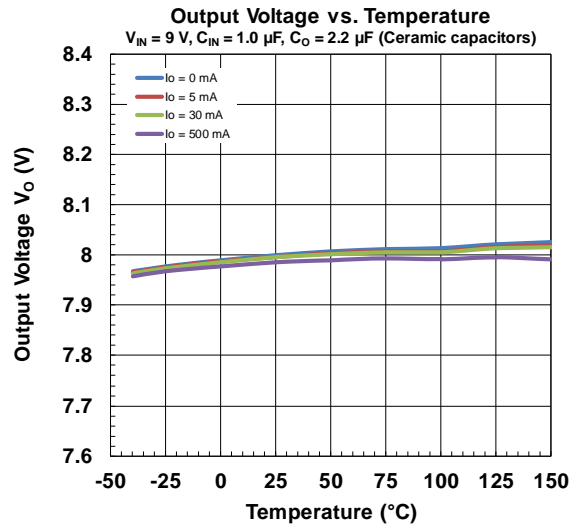
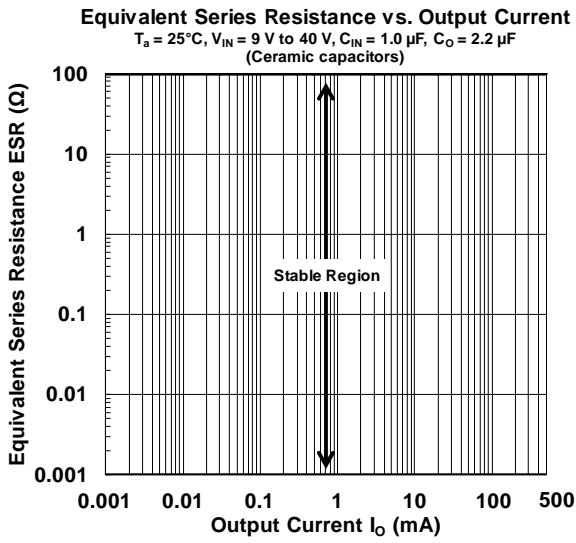

■ TYPICAL CHARACTERISTICS ($V_O = 8\text{ V}$)

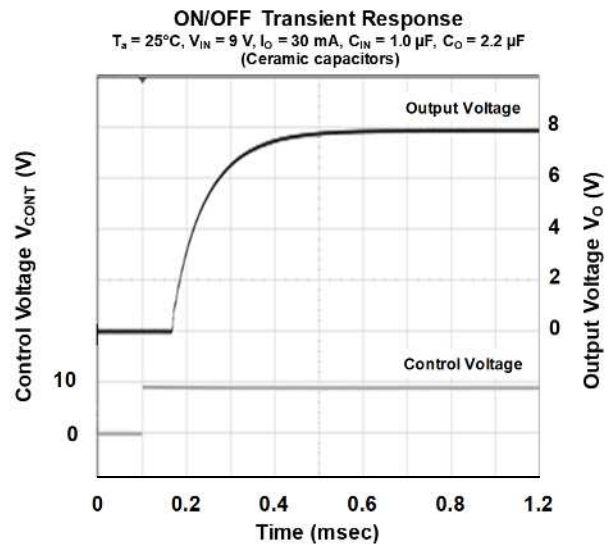
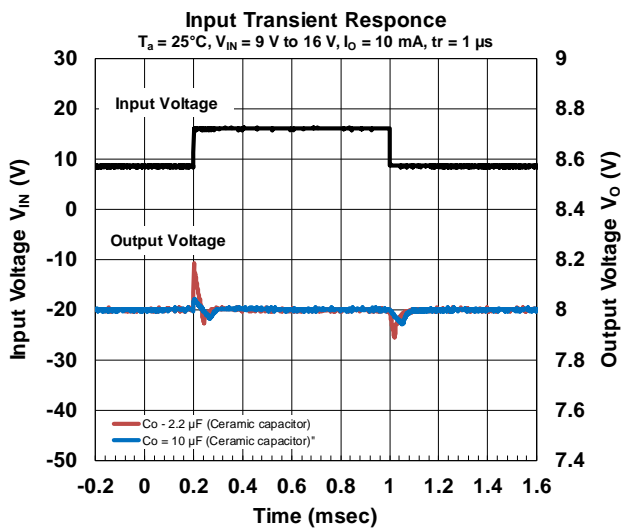
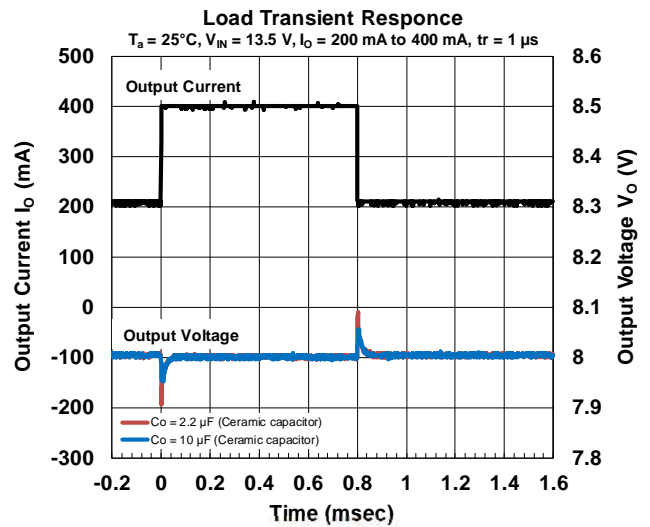
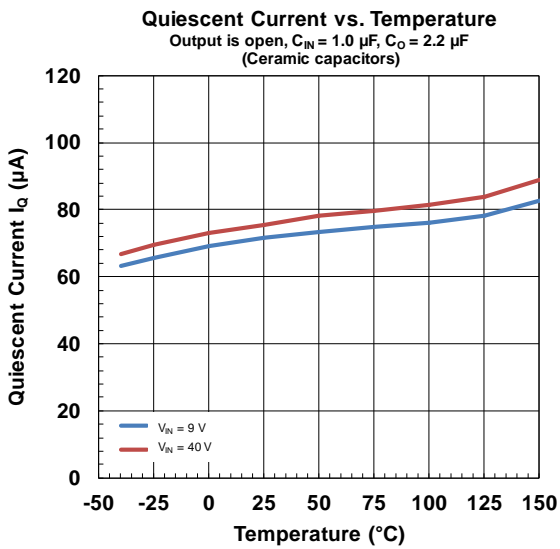
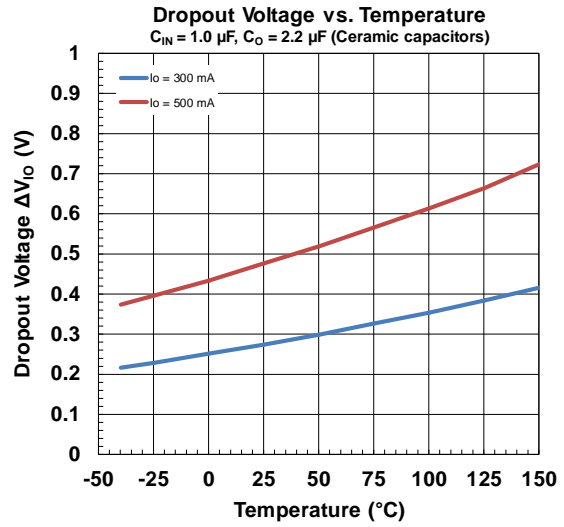
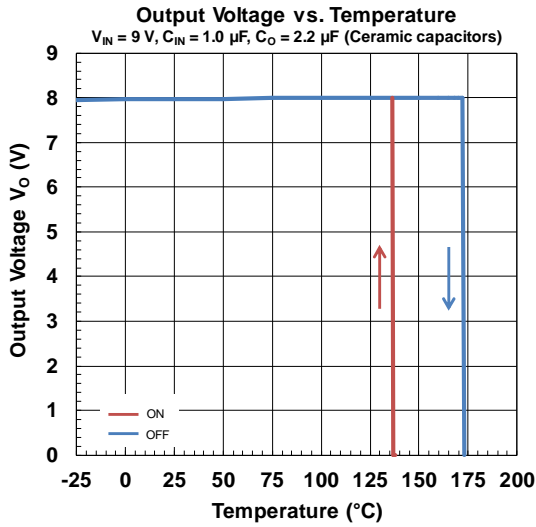

■ TYPICAL APPLICATION

1. When ON/OFF control is used.

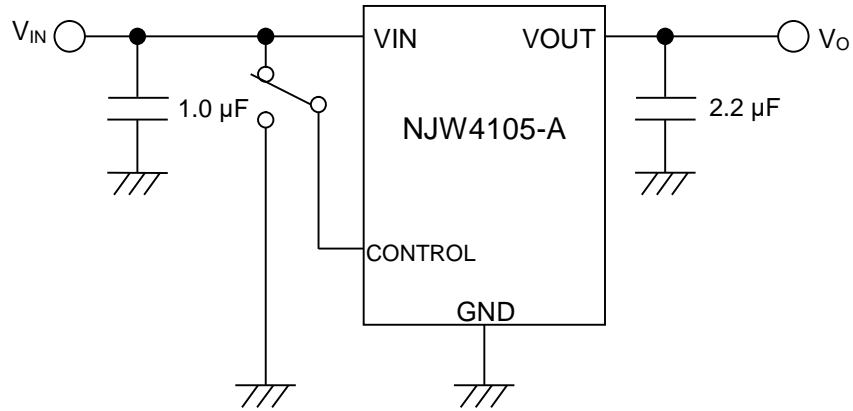

The CONTROL pin is turned on at high level and turned off at open or GND level.

2. When ON/OFF control is not used.

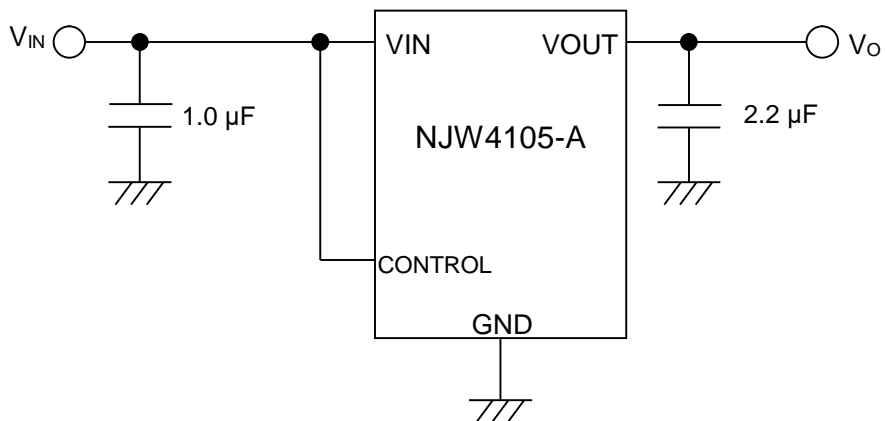

Connect the CONTROL pin to the VIN.

■ APPLICATION NOTE**Input Capacitor (C_{IN})**

The C_{IN} prevents oscillations and reduce power supply ripple of applications when the power supply impedance is high or power supply line is long. Connecting a 1.0 μF or larger C_{IN} between V_{IN} and GND pins as short path as possible.

Output Capacitor (C_O)

C_O is necessary for phase compensation of the internal error amplifier in the regulator, and the capacitance value and ESR affect the stability of the circuit. If a capacitor less than 2.2 μF is used, output noise and/or regulator oscillation may occur due to lack of the phase compensation. For stable operation, connect a 2.2 μF or larger C_O within the stable operation region ($0.001 \Omega \leq \text{ESR} \leq 100 \Omega$) between the V_{OUT} and GND pins as short path as possible. The recommended capacitance value varies depending on the output voltage, and a low output voltage may require a large capacitance value; therefore, confirm the recommended capacitance of the required output voltage. As the capacitance value of C_O increases, output noise and ripple decrease, and the response to output load fluctuations also improves.

Select the output capacitor considering various characteristics such as frequency characteristics, temperature characteristics, and DC bias characteristics. For the C_O, a capacitor with excellent temperature characteristics and sufficient margin for output voltage is recommended.

Undervoltage Lockout (UVLO)

This circuit prevents malfunction by locking out the output when V_{IN} is below the UVLO detection voltage. The output voltage rises when the input voltage rises and exceeds the UVLO release voltage (2.7 V, typ). When the input voltage drops below the UVLO detection voltage (2.2 V, typ)*, the output voltage falls.

*UVLO detection voltage (2.2 V, typ) = UVLO release voltage (2.7 V, typ) – UVLO hysteresis voltage (500 mV, typ)

■ PACKAGE DIMENSIONS

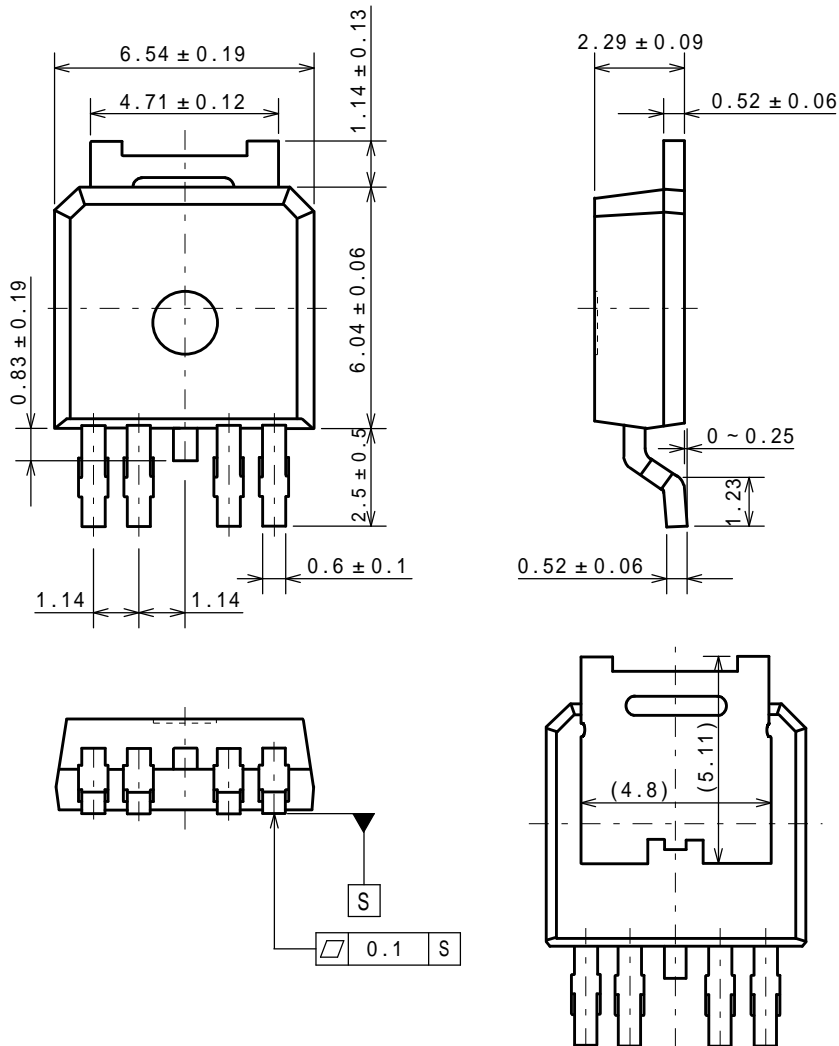

■ EXAMPLE OF SOLDER PADS DIMENSIONS

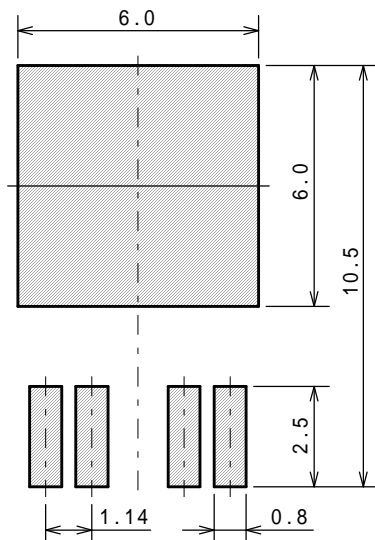

PACKING SPEC

TAPING DIMENSIONS

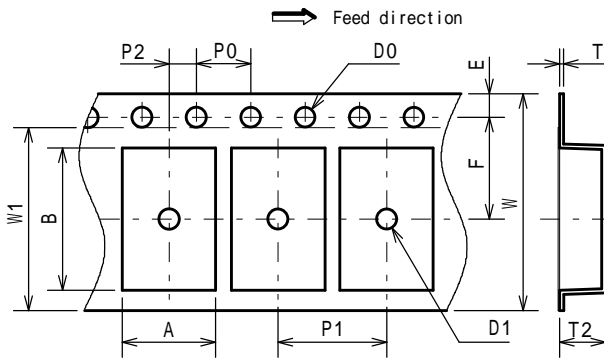

SYMBOL	DIMENSION	REMARKS
A	6.9 ± 0.1	BOTTOM DIMENSION
B	10.5 ± 0.1	BOTTOM DIMENSION
D0	1.5 ^{+0.1} ₀	
D1	1.5 ^{+0.1} ₀	
E	1.75 ± 0.1	
F	7.5 ± 0.1	
P0	4.0 ± 0.1	
P1	8.0 ± 0.1	
P2	2.0 ± 0.1	
T	0.3 ± 0.1	
T2	3.4 max	
W	16.0 ± 0.3	
W1	13.5	THICKNESS 0.1max

REEL DIMENSIONS

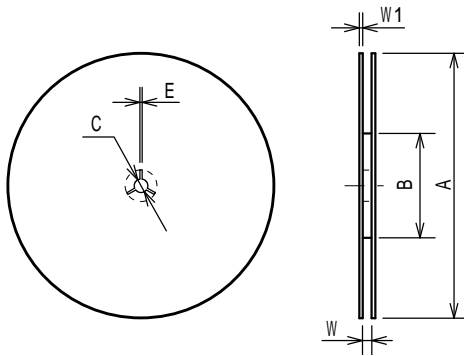

SYMBOL	DIMENSION
A	330 ± 2
B	80 ± 1
C	13 ± 0.5
E	2
W	17.5 ± 0.5
W1	2 ± 0.5

TAPING STATE

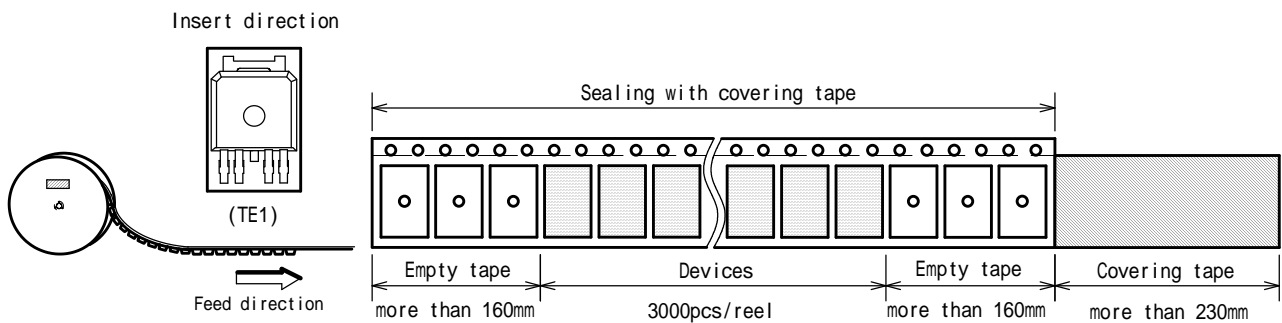

PACKING STATE

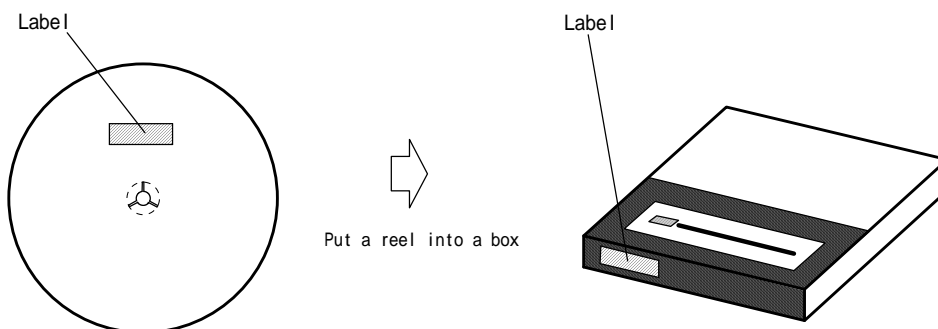

RECOMMENDED MOUNTING METHOD

FLOW SOLDERING PROFILE

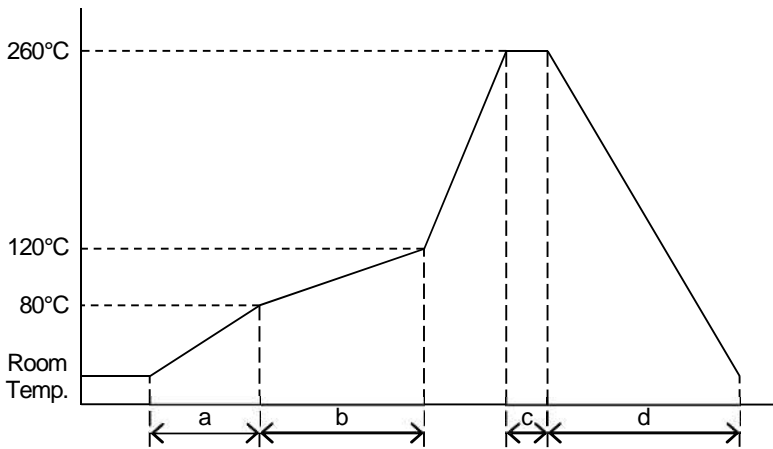

a	Temperature ramping rate	1 to 7°C/s
b	Pre-heating temperature	80 to 120°C
	Pre-heating time	60 to 120s
c	Peak temperature	lower than 260°C
	Peak time	shorter than 10s
d	Temperature ramping rate	1 to 7°C/s

The temperature indicates at the surface of mold package.

INFRARED REFLOW SOLDERING PROFILE

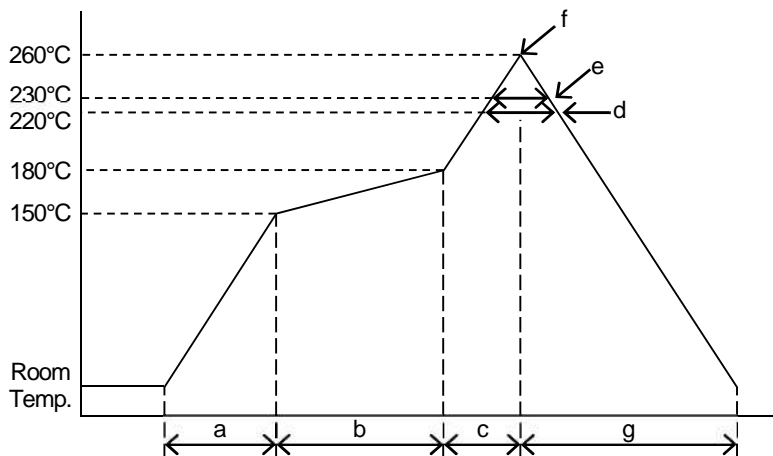

a	Temperature ramping rate	1 to 4°C/s
b	Pre-heating temperature	150 to 180°C
	Pre-heating time	60 to 120s
c	Temperature ramp rate	1 to 4°C/s
d	220°C or higher time	shorter than 60s
e	230°C or higher time	shorter than 40s
f	Peak temperature	lower than 260°C
g	Temperature ramping rate	1 to 6°C/s

The temperature indicates at the surface of mold package.

REVISION HISTORY

DATE	REVISION	CHANGES
October 19, 2020	Ver.1.0	Initial release
January 14, 2021	Ver.1.1	Revised lower limit of ESR

[CAUTION]

1. NJR strives to produce reliable and high quality semiconductors. NJR's semiconductors are intended for specific applications and require proper maintenance and handling. To enhance the performance and service of NJR's semiconductors, the devices, machinery or equipment into which they are integrated should undergo preventative maintenance and inspection at regularly scheduled intervals. Failure to properly maintain equipment and machinery incorporating these products can result in catastrophic system failures
2. The specifications on this datasheet are only given for information without any guarantee as regards either mistakes or omissions. The application circuits in this datasheet are described only to show representative usages of the product and not intended for the guarantee or permission of any right including the industrial property rights.
All other trademarks mentioned herein are the property of their respective companies.
3. To ensure the highest levels of reliability, NJR products must always be properly handled.
The introduction of external contaminants (e.g. dust, oil or cosmetics) can result in failures of semiconductor products.
4. NJR offers a variety of semiconductor products intended for particular applications. It is important that you select the proper component for your intended application. You may contact NJR's Sale's Office if you are uncertain about the products listed in this datasheet.
5. Special care is required in designing devices, machinery or equipment which demand high levels of reliability. This is particularly important when designing critical components or systems whose failure can foreseeably result in situations that could adversely affect health or safety. In designing such critical devices, equipment or machinery, careful consideration should be given to amongst other things, their safety design, fail-safe design, back-up and redundancy systems, and diffusion design.
6. The products listed in this datasheet may not be appropriate for use in certain equipment where reliability is critical or where the products may be subjected to extreme conditions. You should consult our sales office before using the products in any of the following types of equipment.
 - Aerospace Equipment
 - Equipment Used in the Deep Sea
 - Power Generator Control Equipment (Nuclear, steam, hydraulic, etc.)
 - Life Maintenance Medical Equipment
 - Fire Alarms / Intruder Detectors
 - Vehicle Control Equipment (Airplane, railroad, ship, etc.)
 - Various Safety Devices
7. NJR's products have been designed and tested to function within controlled environmental conditions. Do not use products under conditions that deviate from methods or applications specified in this datasheet. Failure to employ the products in the proper applications can lead to deterioration, destruction or failure of the products. NJR shall not be responsible for any bodily injury, fires or accident, property damage or any consequential damages resulting from misuse or misapplication of the products. The products are sold without warranty of any kind, either express or implied, including but not limited to any implied warranty of merchantability or fitness for a particular purpose.
8. Warning for handling Gallium and Arsenic (GaAs) Products (Applying to GaAs MMIC, Photo Reflector). These products use Gallium (Ga) and Arsenic (As) which are specified as poisonous chemicals by law. For the prevention of a hazard, do not burn, destroy, or process chemically to make them as gas or power. When the product is disposed of, please follow the related regulation and do not mix this with general industrial waste or household waste.
9. The product specifications and descriptions listed in this datasheet are subject to change at any time, without notice.

