

## Mechanical Dimensions: Inches [mm]

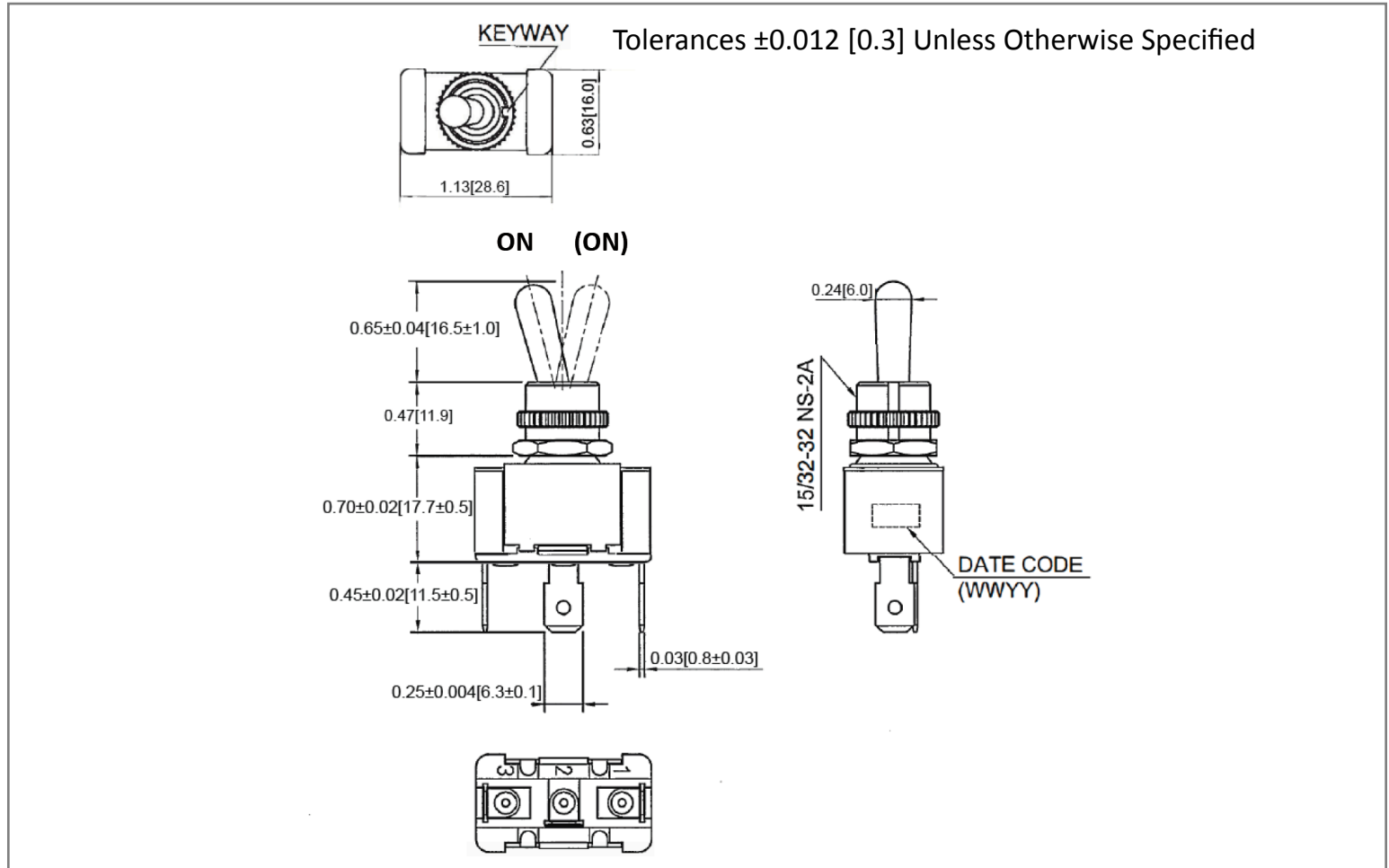

## Mounting Hole

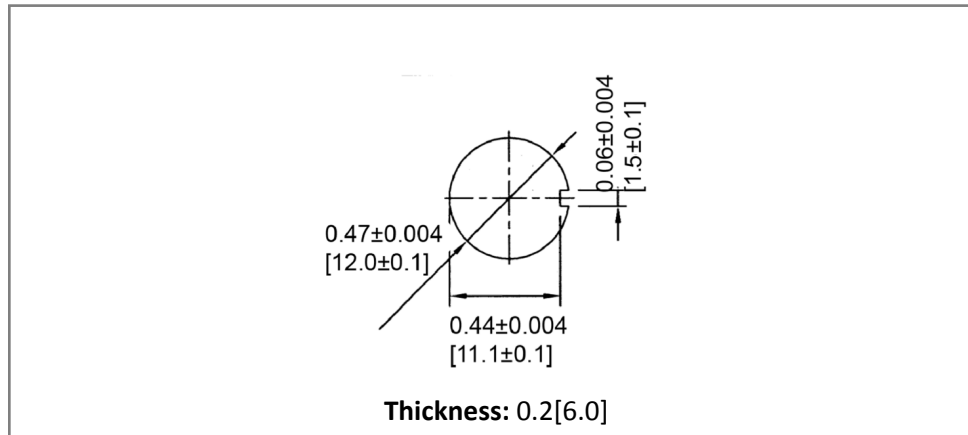

## Circuit Diagram

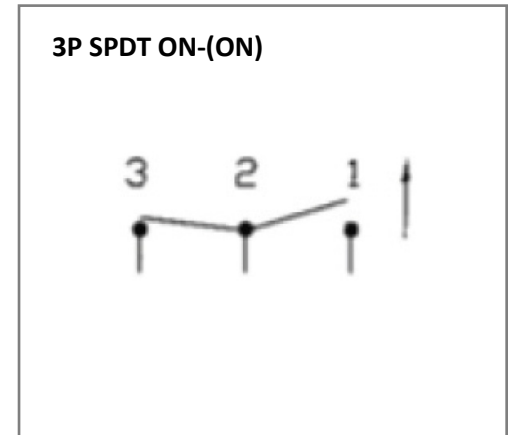

## Electrical Specifications

Rating	21A 14VDC
Contact Resistance	50m ohm Max
Insulation Resistance	DC 500V 100M ohm Min
Dielectric Strength	AC 1500V 1 minute
Operation Temperature	-20°C~85°C

## Material Specifications

Operation Force	700gf $\pm$ 250 gf
	1 Hex Nut Assy
	1 Knurl Nut Assy

**Rev      Date of issue      Revision Notes**

**Designed      Approved**

B	05-17-2021	Initial Drawing	RC	OF
---	------------	-----------------	----	----