

T322D226K020AT7200

Aliases (T322D226K020AT7241, T322D226K020ATTR)

T322, Tantalum, MnO2 Tantalum, Commercial Grade, 22 uF, 10%, 20 VDC, 1.8 Ohms

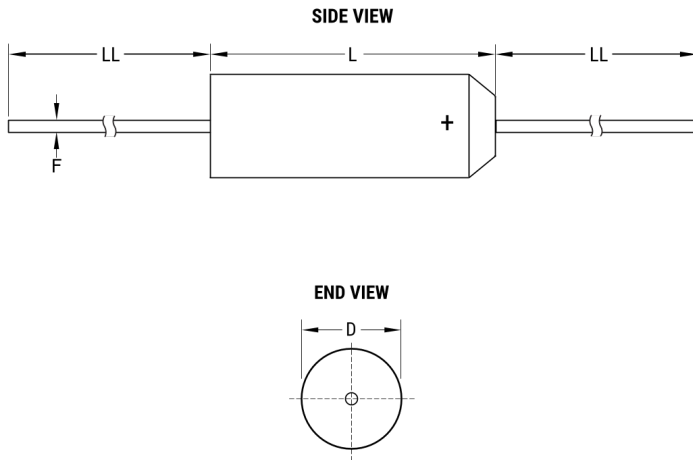

General Information	
Series	T322
Dielectric	MnO2 Tantalum
Style	Axial
Description	Axial, Solid Tantalum, Molded, Military (Non-ER), Low ESR
Features	Low ESR
RoHS	Yes
Termination	Tin
Lead	Wire Leads
AEC-Q200	No
Notes	Uninsulated.
Shelf Life	156 Weeks

Click [here](#) for the 3D model.

Specifications	
Capacitance	22 uF
Capacitance Tolerance	10%
Voltage DC	20 VDC (85C), 13.34 VDC (125C Surge), 0.2 VDC (125C Reverse)
Temperature Range	-55/+125°C
Rated Temperature	85°C
Dissipation Factor	6%
Resistance	1.8 Ohms (100kHz)
Leakage Current	3.5 uA (25°C)

Dimensions	
D	4.57mm MAX
L	10.67mm MAX
LL	25.4mm MIN
F	0.51mm +/-0.05mm

Packaging Specifications	
Packaging	T&R, 305mm, Class I, B = 52.4mm
Packaging Quantity	2500

Statements of suitability for certain applications are based on our knowledge of typical operating conditions for such applications, but are not intended to constitute - and we specifically disclaim - any warranty concerning suitability for a specific customer application or use. This Information is intended for use only by customers who have the requisite experience and capability to determine the correct products for their application. Any technical advice inferred from this Information or otherwise provided by us with reference to the use of our products is given gratis, and we assume no obligation or liability for the advice given or results obtained.