

## High Voltage LED Series Chip on Board

# LCo40D – Gen.1



High efficacy COB LED package  
well-suited for use in spotlight applications

### Features & Benefits

- Chip on Board (COB) solution makes it easy to design in
- Simple assembly reduces manufacturing cost
- Low thermal resistance
- InGaN/GaN MQW LED with long time reliability

### Applications

- Spotlight / Downlight
- LED Retrofit Bulbs
- Outdoor Illumination



## Table of Contents

|    |                                     |       |    |
|----|-------------------------------------|-------|----|
| 1. | Characteristics                     | ----- | 3  |
| 2. | Product Code Information            | ----- | 5  |
| 3. | Typical Characteristics Graphs      | ----- | 9  |
| 4. | Outline Drawing & Dimension         | ----- | 12 |
| 5. | Reliability Test Items & Conditions | ----- | 13 |
| 6. | Label Structure                     | ----- | 14 |
| 7. | Packing Structure                   | ----- | 15 |
| 8. | Precautions in Handling & Use       | ----- | 17 |

## 1. Characteristics

### a) Absolute Maximum Rating

| Item                            | Symbol    | Rating     | Unit | Condition |
|---------------------------------|-----------|------------|------|-----------|
| Ambient / Operating Temperature | $T_a$     | -40 ~ +105 | °C   | -         |
| Storage Temperature             | $T_{stg}$ | -40 ~ +120 | °C   | -         |
| LED Junction Temperature        | $T_J$     | 140        | °C   | -         |
| Case Temperature                | $T_c$     | 105        | °C   | -         |
| Forward Current                 | $I_F$     | 2760       | mA   | -         |
| Power Dissipation               | $P_D$     | 103.5      | W    | -         |
| ESD (HBM)                       | -         | ±2         | kV   | -         |
| ESD (MM)                        | -         | ±0.5       | kV   | -         |

### b) Electro-optical Characteristics ( $I_F = 1080 \text{ mA}$ , $T_J = 85 \text{ °C}$ )

| Item  | Unit | Rank | Min. | Typ. | Max. |
|---|------|------|------|------|------|
| Forward Voltage ( $V_F$ )                   | V    | YZ   | 31.8 | 34.6 | 37.5 |
| Color Rendering Index ( $R_a$ )             | -    | 5    | 80   | -    | -    |
|   |      | 7    | 90   | -    | -    |
| Thermal Resistance (junction to chip point) | °C/W |      | -    | 0.8  | -    |
| Beam Angle                                  | °    |      | -    | 115  | -    |
| Nominal Power                               | W    |      |      | 40.5 |      |

#### Notes:

- 1) The COB is tested in pulsed condition at rated test current (10 ms pulse width) and rated temperature ( $T_J = T_C = T_a = 85 \text{ °C}$ )
- 2) Samsung maintains measurement tolerance of: forward voltage = ±5 %, CRI = ±1
- 3) Refer to the derating curve, '3. Typical Characteristics Graph' designed within the range.

c) Luminous Flux Characteristics ( $I_F = 1080 \text{ mA}$ )

| CRI ( $R_a$ )<br>Min. | Nominal<br>CCT (K) | Flux<br>Rank | Flux @ $T_J = 85 \text{ }^\circ\text{C}$ (lm) |      |      |
|-----------------------|--------------------|--------------|---|------|------|
|                       |                    |              | Min.  | Typ. | Max. |
| 80                    | 2700               | M7           | 4746  | 4996 | -    |
|                       |                    | D1           | 4996  | 5246 | -    |
|                       | 3000               | M9           | 4994  | 5257 | -    |
|                       |                    | D1           | 5257  | 5520 | -    |
|                       | 3500               | N1           | 5147  | 5418 | -    |
|                       |                    | D1           | 5418  | 5689 | -    |
|                       | 4000               | N2           | 5258  | 5535 | -    |
|                       |                    | D1           | 5535  | 5812 | -    |
|                       | 5000               | N2           | 5283  | 5561 | -    |
|                       |                    | D1           | 5561  | 5839 | -    |
|                       | 5700               | N3           | 5309  | 5588 | -    |
|                       |                    | D1           | 5588  | 5868 | -    |
|                       | 6500               | N2           | 5251  | 5528 | -    |
|                       |                    | D1           | 5528  | 5804 | -    |

| CRI ( $R_a$ )<br>Min. | Nominal<br>CCT (K) | Flux<br>Rank | Flux @ $T_J = 85 \text{ }^\circ\text{C}$ (lm) |      |      |
|-----------------------|--------------------|--------------|---|------|------|
|                       |                    |              | Min.  | Typ. | Max. |
| 90                    | 2700               | M0           | 4068  | 4283 | -    |
|                       |                    | D1           | 4283  | 4497 | -    |
|                       | 3000               | M2           | 4298  | 4525 | -    |
|                       |                    | D1           | 4525  | 4751 | -    |
|                       | 3500               | M4           | 4408  | 4640 | -    |
|                       |                    | D1           | 4640  | 4872 | -    |
|                       | 4000               | M5           | 4505  | 4742 | -    |
|                       |                    | D1           | 4742  | 4979 | -    |
|                       | 5000               | M5           | 4556  | 4796 | -    |
|                       |                    | D1           | 4796  | 5036 | -    |

**Notes:**

- 1) The COB is tested in pulsed operating condition at rated test current (10 ms pulse width) and rated temperature ( $T_J = T_C = 85 \text{ }^\circ\text{C}$ ).
- 2) Samsung maintains measurement tolerance of: Luminous flux =  $\pm 7 \%$ , CRI =  $\pm 1$

## 2. Product Code Information

|   |   |   |   |   |   |   |   |   |    |    |    |    |    |    |    |    |    |
|---|---|---|---|---|---|---|---|---|----|----|----|----|----|----|----|----|----|
| 1 | 2 | 3 | 4 | 5 | 6 | 7 | 8 | 9 | 10 | 11 | 12 | 13 | 14 | 15 | 16 | 17 | 18 |
| S | P | H | W | H | A | H | D | N | K  | 2  | 5  | Y  | Z  | W  | 3  | M  | 7  |

| Digit | PKG Information            | Code   | Specification   |
|-------|----------------------------|--|---|
| 1 2 3 | Samsung Package High Power | <b>SPH</b>   |   |
| 4 5   | Color                      | <b>WH</b>  | White   |
| 6     | Product Version            | <b>A</b>   |   |
| 7 8   | Form Factor                | <b>HD</b>  | COB   |
| 9     | Lens Type                  | <b>N</b>   | No lens   |
| 10    | Wattage or Model           | <b>K</b>   | LC040D  |
| 11    | Internal Code              | <b>2</b>   |   |
| 12    | CRI & Sorting Temperature  | <b>5</b><br><b>7</b>   | Min. 80 (85°C)<br>Min. 90 (85°C)  |
| 13 14 | Forward Voltage (V)        | <b>YZ</b>  | 31.8~37.5   |
| 15    | CCT (K)                    | <b>W</b><br><b>V</b><br><b>U</b><br><b>T</b><br><b>R</b><br><b>Q</b><br><b>P</b>   | 2700K<br>3000K<br>3500K<br>4000K<br>5000K<br>5700K<br>6500K   |
| 16    | MacAdam Step               | <b>2</b><br><b>3</b>   | MacAdam 2-step<br>MacAdam 3-step  |
| 17 18 | Luminous Flux              | <b>M0</b><br><b>M2</b><br><b>M4</b><br><b>M5</b><br><b>M7</b><br><b>M9</b><br><b>N1</b><br><b>N2</b><br><b>N3</b><br><b>D1</b> | Min. 4000<br>Min. 4200<br>Min. 4400<br>Min. 4500<br>Min. 4700<br>Min. 4900<br>Min. 5100<br>Min. 5200<br>Min. 5300<br>Add rank |

a) Binning Structure ( $I_F = 1080 \text{ mA}$ ,  $T_J = 85 \text{ }^\circ\text{C}$ )

| CRI ( $R_a$ )<br>Min. | Nominal<br>CCT (K) | Product Code       | $V_F$<br>Rank | Color<br>Rank | Flux<br>Rank | Flux Range<br>( $\Phi_v$ , lm) |
|-----------------------|--------------------|--------------------|---------------|---------------|--------------|--------------------------------|
| 80                    | 2700               | SPHWWAHDNK25YZW2M7 | YZ            | W2            | M7           | 4746 ~                         |
|                       |                    | SPHWWAHDNK25YZW3M7 |               | W3            |              |                                |
|                       |                    | SPHWWAHDNK25YZW2D1 |               | W2            | D1           |                                |
|                       |                    | SPHWWAHDNK25YZW3D1 |               | W3            |              |                                |
|                       | 3000               | SPHWWAHDNK25YZV2M9 | YZ            | V2            | M9           | 4994 ~                         |
|                       |                    | SPHWWAHDNK25YZV3M9 |               | V3            |              |                                |
|                       |                    | SPHWWAHDNK25YZV2D1 |               | V2            | D1           |                                |
|                       |                    | SPHWWAHDNK25YZV3D1 |               | V3            |              |                                |
|                       | 3500               | SPHWWAHDNK25YZU2N1 | YZ            | U2            | N1           | 5147 ~                         |
|                       |                    | SPHWWAHDNK25YZU3N1 |               | U3            |              |                                |
|                       |                    | SPHWWAHDNK25YZU2D1 |               | U2            | D1           |                                |
|                       |                    | SPHWWAHDNK25YZU3D1 |               | U3            |              |                                |
|                       | 4000               | SPHWWAHDNK25YZT2N2 | YZ            | T2            | N2           | 5258 ~                         |
|                       |                    | SPHWWAHDNK25YZT3N2 |               | T3            |              |                                |
|                       |                    | SPHWWAHDNK25YZT2D1 |               | T2            | D1           |                                |
|                       |                    | SPHWWAHDNK25YZT3D1 |               | T3            |              |                                |
|                       | 5000               | SPHWWAHDNK25YZR3N2 | YZ            | R3            | N2           | 5283 ~                         |
|                       |                    | SPHWWAHDNK25YZR3D1 |               |               | D1           | 5561 ~                         |
|                       | 5700               | SPHWWAHDNK25YZQ3N3 | YZ            | Q3            | N3           | 5309 ~                         |
|                       |                    | SPHWWAHDNK25YZQ3D1 |               |               | D1           | 5588 ~                         |
| 6500                  | SPHWWAHDNK25YZP3N2 | YZ                 | P3            | N2            | 5251 ~       |                                |
|                       | SPHWWAHDNK25YZP3D1 |                    |               | D1            | 5528 ~       |                                |

| CRI (R <sub>a</sub> )<br>Min. | Nominal<br>CCT (K) | Product Code       | V <sub>F</sub><br>Rank | Color<br>Rank | Flux<br>Rank | Flux Range<br>(Φ <sub>v</sub> , lm) |
|-------------------------------|--------------------|--------------------|------------------------|---------------|--------------|-------------------------------------|
| 90                            | 2700               | SPHWHAHDNK27YZW2M0 | YZ                     | W2            | M0           | 4068 ~                              |
|                               |                    | SPHWHAHDNK27YZW3M0 |                        | W3            |              |                                     |
|                               |                    | SPHWHAHDNK27YZW2D1 |                        | W2            | D1           |                                     |
|                               |                    | SPHWHAHDNK27YZW3D1 |                        | W3            |              |                                     |
|                               | 3000               | SPHWHAHDNK27YZV2M2 | YZ                     | V2            | M2           | 4298 ~                              |
|                               |                    | SPHWHAHDNK27YZV3M2 |                        | V3            |              |                                     |
|                               |                    | SPHWHAHDNK27YZV2D1 |                        | V2            | D1           |                                     |
|                               |                    | SPHWHAHDNK27YZV3D1 |                        | V3            |              |                                     |
|                               | 3500               | SPHWHAHDNK27YZU2M4 | YZ                     | U2            | M4           | 4408 ~                              |
|                               |                    | SPHWHAHDNK27YZU3M4 |                        | U3            |              |                                     |
|                               |                    | SPHWHAHDNK27YZU2D1 |                        | U2            | D1           |                                     |
|                               |                    | SPHWHAHDNK27YZU3D1 |                        | U3            |              |                                     |
|                               | 4000               | SPHWHAHDNK27YZT2M5 | YZ                     | T2            | M5           | 4505 ~                              |
|                               |                    | SPHWHAHDNK27YZT3M5 |                        | T3            |              |                                     |
|                               |                    | SPHWHAHDNK27YZT2D1 |                        | T2            | D1           |                                     |
|                               |                    | SPHWHAHDNK27YZT3D1 |                        | T3            |              |                                     |
|                               | 5000               | SPHWHAHDNK27YZR3M5 | YZ                     | R3            | M5           | 4556 ~                              |
|                               |                    | SPHWHAHDNK27YZR3D1 |                        | R3            | D1           | 4796 ~                              |

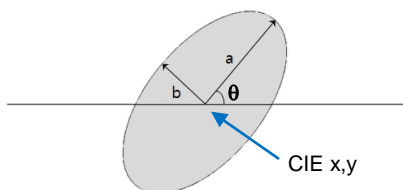
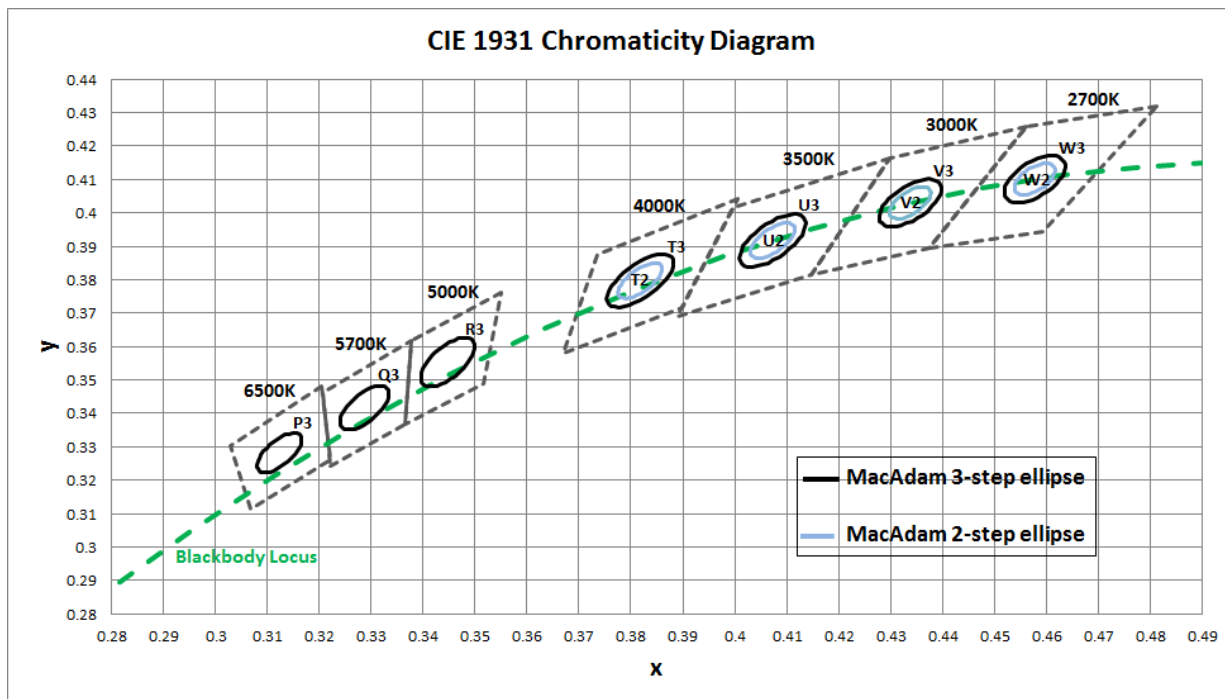
**b) Chromaticity Region & Coordinates ( $I_F = 1080 \text{ mA}$ ,  $T_J = 85 \text{ }^\circ\text{C}$ )**

| MacAdam Ellipse (W2, W3) |        |        |          |        |        |
|--------------------------|--------|--------|----------|--------|--------|
| Step                     | CIE x  | CIE y  | $\theta$ | a      | b      |
| 2-step                   | 0.4578 | 0.4101 | 53.70    | 0.0054 | 0.0028 |
| 3-step                   | 0.4578 | 0.4101 | 53.70    | 0.0081 | 0.0042 |

| MacAdam Ellipse (V2, V3) |        |        |          |        |        |
|--------------------------|--------|--------|----------|--------|--------|
| Step                     | CIE x  | CIE y  | $\theta$ | a      | b      |
| 2-step                   | 0.4338 | 0.403  | 53.22    | 0.0056 | 0.0027 |
| 3-step                   | 0.4338 | 0.4030 | 53.22    | 0.0083 | 0.0041 |

| MacAdam Ellipse (U2, U3) |        |        |          |        |        |
|--------------------------|--------|--------|----------|--------|--------|
| Step                     | CIE x  | CIE y  | $\theta$ | a      | b      |
| 2-step                   | 0.4073 | 0.3917 | 54.00    | 0.0062 | 0.0028 |
| 3-step                   | 0.4073 | 0.3917 | 54.00    | 0.0093 | 0.0041 |

| MacAdam Ellipse (T2, T3) |        |        |          |        |        |
|--------------------------|--------|--------|----------|--------|--------|
| Step                     | CIE x  | CIE y  | $\theta$ | a      | b      |
| 2-step                   | 0.3818 | 0.3797 | 53.72    | 0.0063 | 0.0027 |
| 3-step                   | 0.3818 | 0.3797 | 53.72    | 0.0094 | 0.0040 |

| MacAdam Ellipse (R3) |        |        |          |        |        |
|----------------------|--------|--------|----------|--------|--------|
| Step                 | CIE x  | CIE y  | $\theta$ | a      | b      |
| 3-step               | 0.3447 | 0.3553 | 59.62    | 0.0082 | 0.0035 |

| MacAdam Ellipse (Q3) |        |        |          |        |        |
|----------------------|--------|--------|----------|--------|--------|
| Step                 | CIE x  | CIE y  | $\theta$ | a      | b      |
| 3-step               | 0.3287 | 0.3417 | 59.0950  | 0.0075 | 0.0032 |

| MacAdam Ellipse (P3) |        |        |          |        |        |
|----------------------|--------|--------|----------|--------|--------|
| Step                 | CIE x  | CIE y  | $\theta$ | a      | b      |
| 3-step               | 0.3123 | 0.3282 | 58.5700  | 0.0067 | 0.0029 |

**Note:**

Samsung maintains measurement tolerance of:  $C_x, C_y = \pm 0.005$



### 3. Typical Characteristics Graphs

#### a) Spectrum Distribution ( $I_F = 1080 \text{ mA}$ , $T_J = 85 \text{ }^\circ\text{C}$ )

CCT: 2700 K (80 CRI)

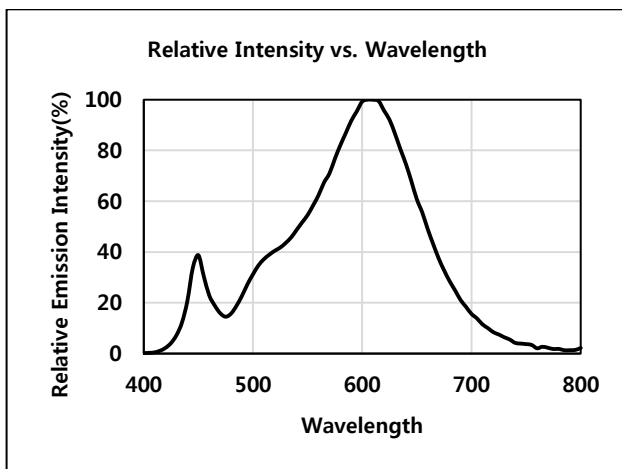

CCT: 3000 K (80 CRI)

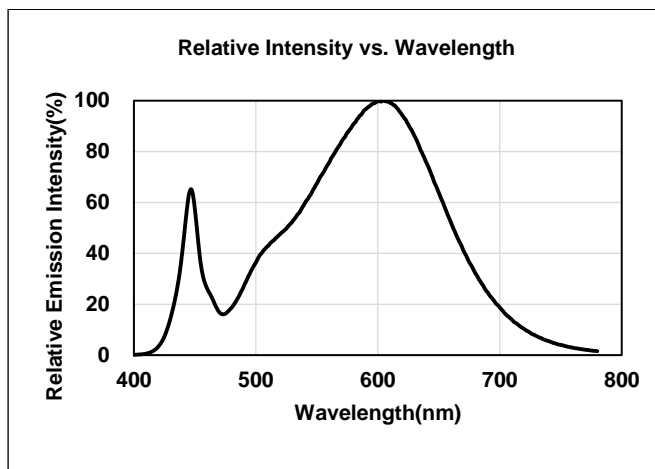

CCT: 3500 K (80 CRI)

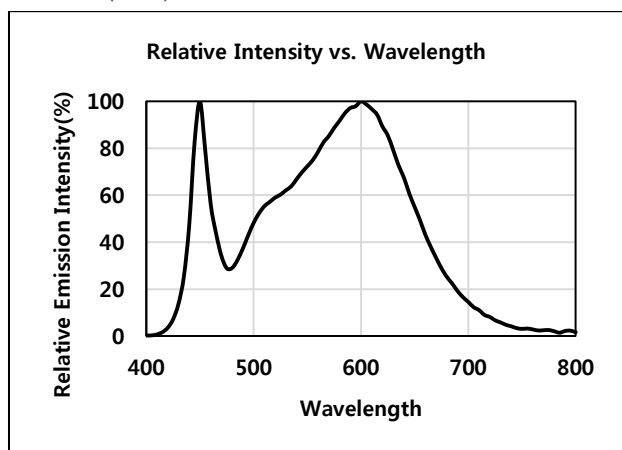

CCT: 4000 K (80 CRI)

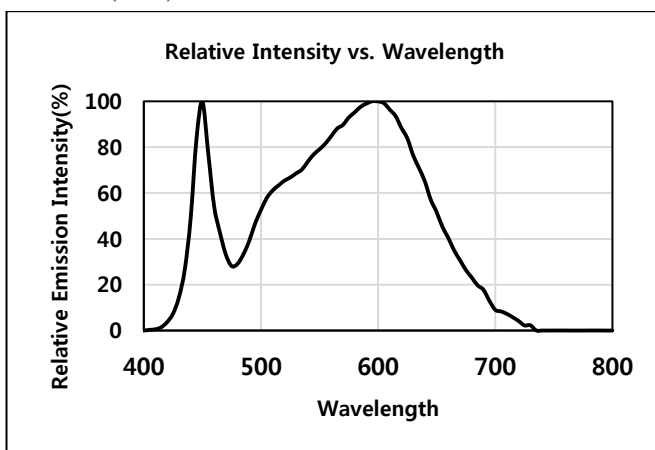

CCT: 5000 K (80 CRI)

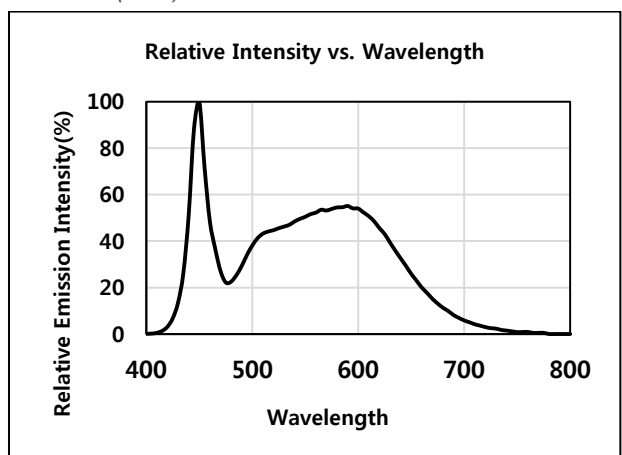

CCT: 5700 K (80 CRI)

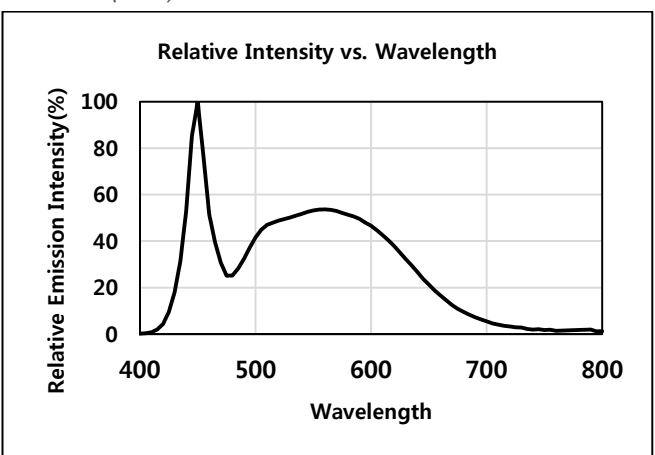

CCT: 6500 K (80 CRI)

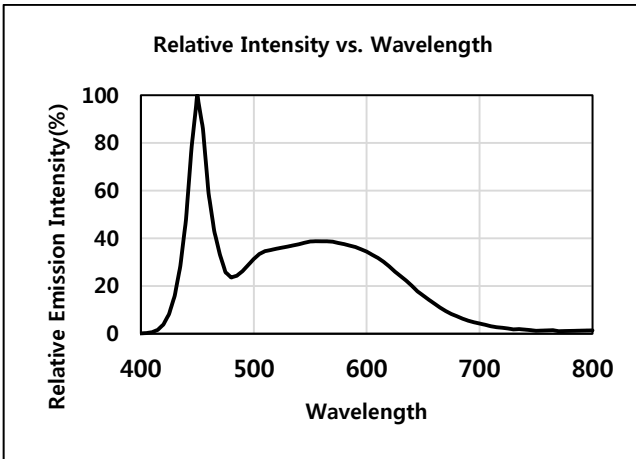

### b) Forward Current Characteristics ( $T_J = 85^\circ\text{C}$ )

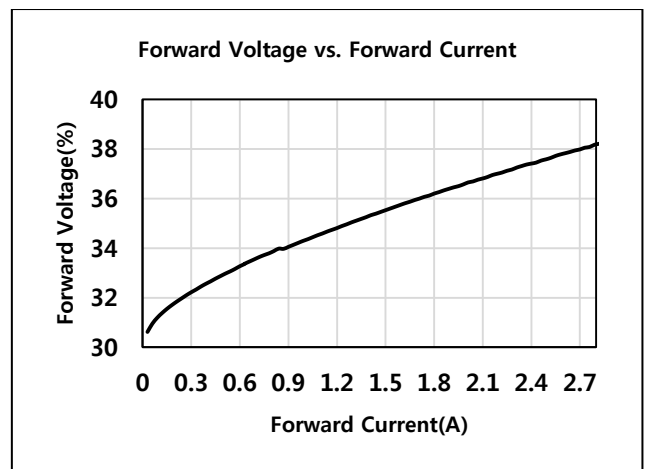
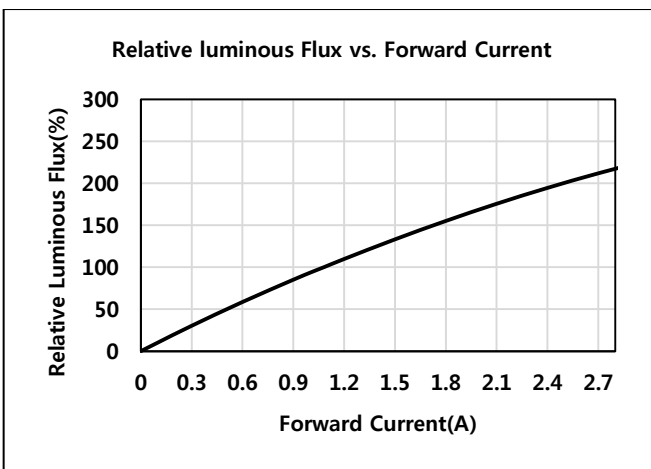

### c) Temperature Characteristics ( $I_F = 1080\text{mA}$ )

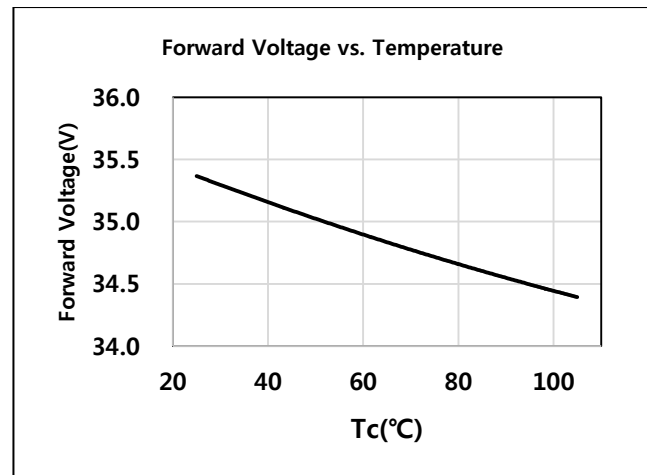
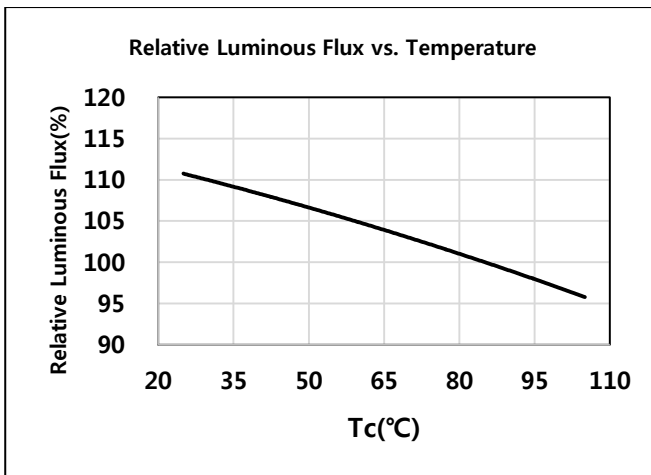

d) Color Shift Characteristics ( $T_J = 25\text{ }^\circ\text{C}$ ,  $I_F = 1080\text{mA}$ , CRI80+)

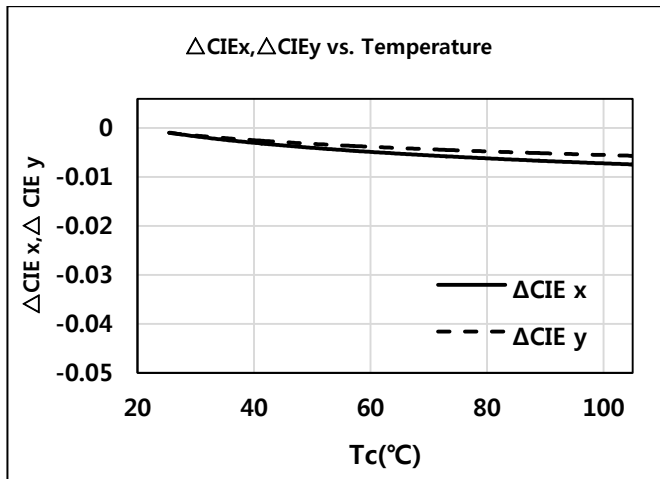
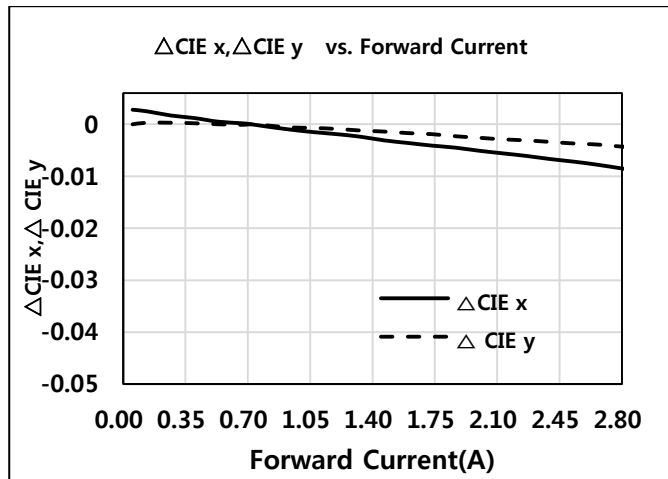

e) Beam Angle Characteristics ( $I_F = 1080\text{ mA}$ ,  $T_J = 85\text{ }^\circ\text{C}$ )

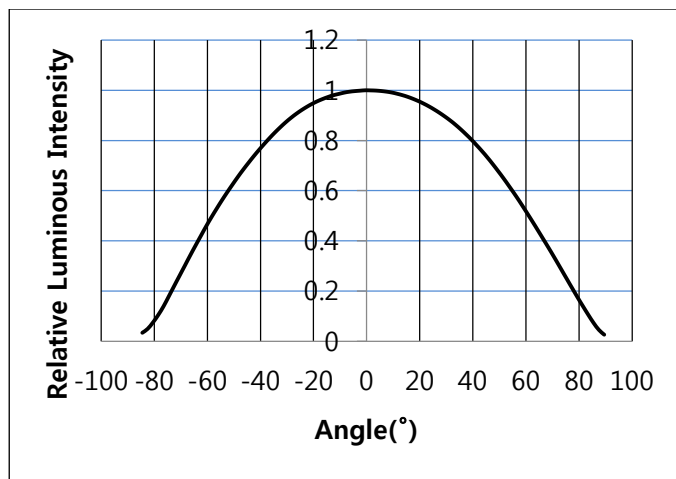

f) Derating Characteristics

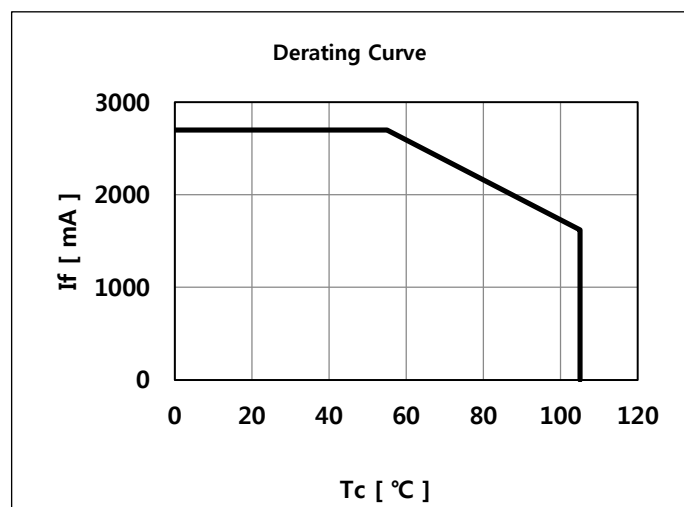

### 4. Outline Drawing & Dimension

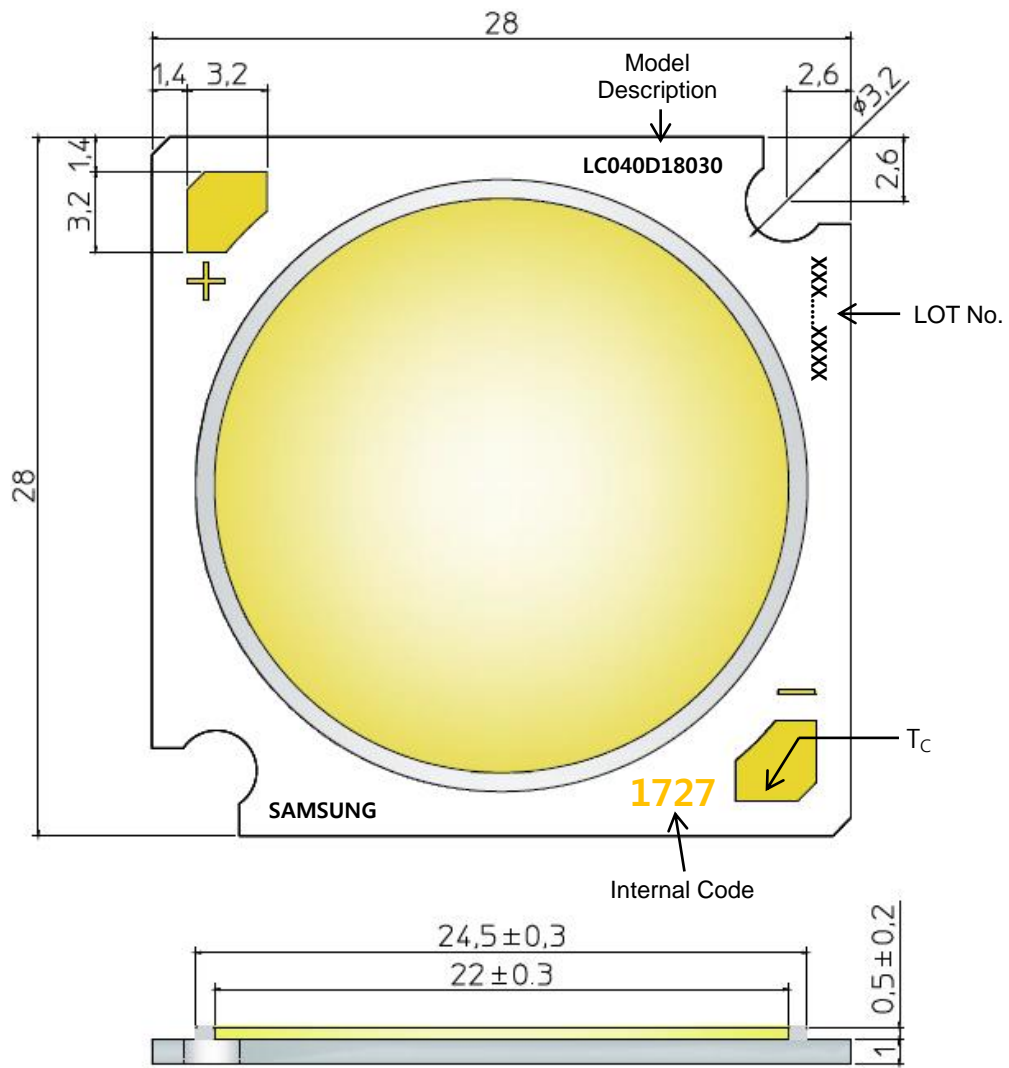

- 1. Unit: mm
- 2. Tolerance: ± 0.3 mm

| Item                                  | Dimension | Tolerance | Unit |
|---------------------------------------|-----------|-----------|------|
| Length                                | 28.0      | ±0.15     | mm   |
| Width                                 | 28.0      | ±0.15     | mm   |
| Height                                | 1.50      | ±0.20     | mm   |
| Light Emitting Surface (LES) Diameter | 22.0      | ±0.30     | mm   |

Note: Denoted product information above is only an example  
 ( LC040D18030 : LC040D, CRI80+, 3000K )

## 5. Reliability Test Items & Conditions

### a) Test Items

| Test Item                           | Test Condition  | Test Hour / Cycle |
|-------------------------------------|---|-------------------|
| High Temperature Humidity Life Test | 60 °C, 90 % RH,, DC Derating, $I_F$   | 1000 h            |
| High Temperature Life Test          | 85 °C, DC Derating, $I_F$   | 1000 h            |
| Low Temperature Life Test           | -40 °C, DC , $I_F = 1900$ mA  | 1000 h            |
| Pulsed Operating Life Test          | 55 °C, Pulse width 100 $\mu$ s, duty cycle 3 %  | 1000 h            |
| High Temperature Storage            | 120 °C  | 1000 h            |
| Low Temperature Storage             | -40 °C  | 1000 h            |
| Temperature Humidity Storage        | 60 °C, 90% RH   | 1000h             |
| Thermal Cycle                       | -45 °C / 15 min $\leftrightarrow$ 125 °C / 15 min<br>temperature change in 5 min  | 500 cycles        |
| Temperature Cycle On/Off Test       | -40 °C / 85 °C each 20 min, 30 min transfer<br>power on/off each 5 min, DC Derating, $I_F = \text{max}$                                     | 100 cycles        |
| ESD (HBM)                           | $R_1$ : 10 M $\Omega$<br>$R_2$ : 1.5 k $\Omega$<br>C: 100 pF<br>V: $\pm 2$ kV   | 5 times           |
| ESD (MM)                            | $R_1$ : 10 M $\Omega$<br>$R_2$ : 0 k $\Omega$<br>C: 200 pF<br>V: $\pm 0.2$ kV   | 5 times           |
| Vibration Test                      | 20 ~ 80 Hz (displacement: 0.06 inch, max. 20 g)<br>80 ~ 2 kHz (max. 20 g)<br>min. frequency $\leftrightarrow$ max. frequency 4 min transfer | 4 times           |
| Mechanical Shock Test               | 1500 g, 0.5 ms<br>each of the 6 surfaces (3 axis x 2 sides)   | 5 times           |
| Sulfur Resistance                   | 25 °C, 75%, H2S 15 ppm  | 504h              |

### b) Criteria for Judging the Damage

| Item            | Symbol   | Test Condition<br>( $T_c = 25$ °C) | Limit        |              |
|-----------------|----------|------------------------------------|--------------|--------------|
|                 |          |                                    | Min.         | Max.         |
| Forward Voltage | $V_F$    | $I_F = 1080$ mA                    | L.S.L. * 0.9 | U.S.L. * 1.1 |
| Luminous Flux   | $\Phi_v$ | $I_F = 1080$ mA                    | L.S.L * 0.7  | U.S.L * 1.3  |

## 6. Label Structure

### a) Label Structure

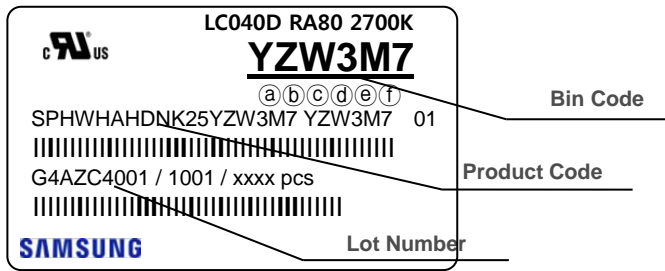

Note: Denoted bin code and product code above is only an example (see description on page 5)

Bin Code:

- ⒶⒷ: Forward Voltage bin (refer to page 11)
- ⒸⒹ: Chromaticity bin (refer to page 9-10)
- ⒺⒻ: Luminous Flux bin (refer to page 6)

### b) Lot Number

The lot number is composed of the following characters:

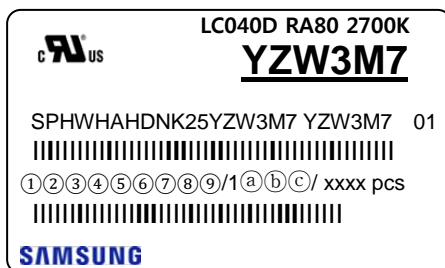

① ③④⑤⑥⑦⑧⑨ / 1ⒶⒷⒸ / xxxx pcs

- ① : Production site (S: Giheung, Korea, G: Tianjin, China)
- ② : 4 (LED)
- ③ : Product state (A: Normal, B: Bulk, C: First Production, R: Reproduction, S: Sample)
- ④ : Year (Z: 2015, A: 2016, B: 2017...)
- ⑤ : Month (1~9, A, B, C)
- ⑥⑦⑧⑨ : Day (1~9, A, B~V)
- ⒶⒷⒸ : Product serial number (001 ~ 999)

## 6. Packing Structure

| Packing material    | Max. quantity<br>in pcs of COB | Dimension(mm) |       |        |           |
|---------------------|--------------------------------|---------------|-------|--------|-----------|
|                     |                                | Length        | Width | Height | Tolerance |
| <b>Tray</b>         | 16                             | 160           | 180   | 10     | 1.0       |
| <b>Aluminum Bag</b> | 32(2 trays)                    | 210           | 241   |        | 10        |
| <b>Inner Box</b>    | 128                            | 230           | 84    | 260    | 2         |
| <b>Outer Box</b>    | 1280                           | 476           | 445   | 272    | 5         |

### a) Packing Structure

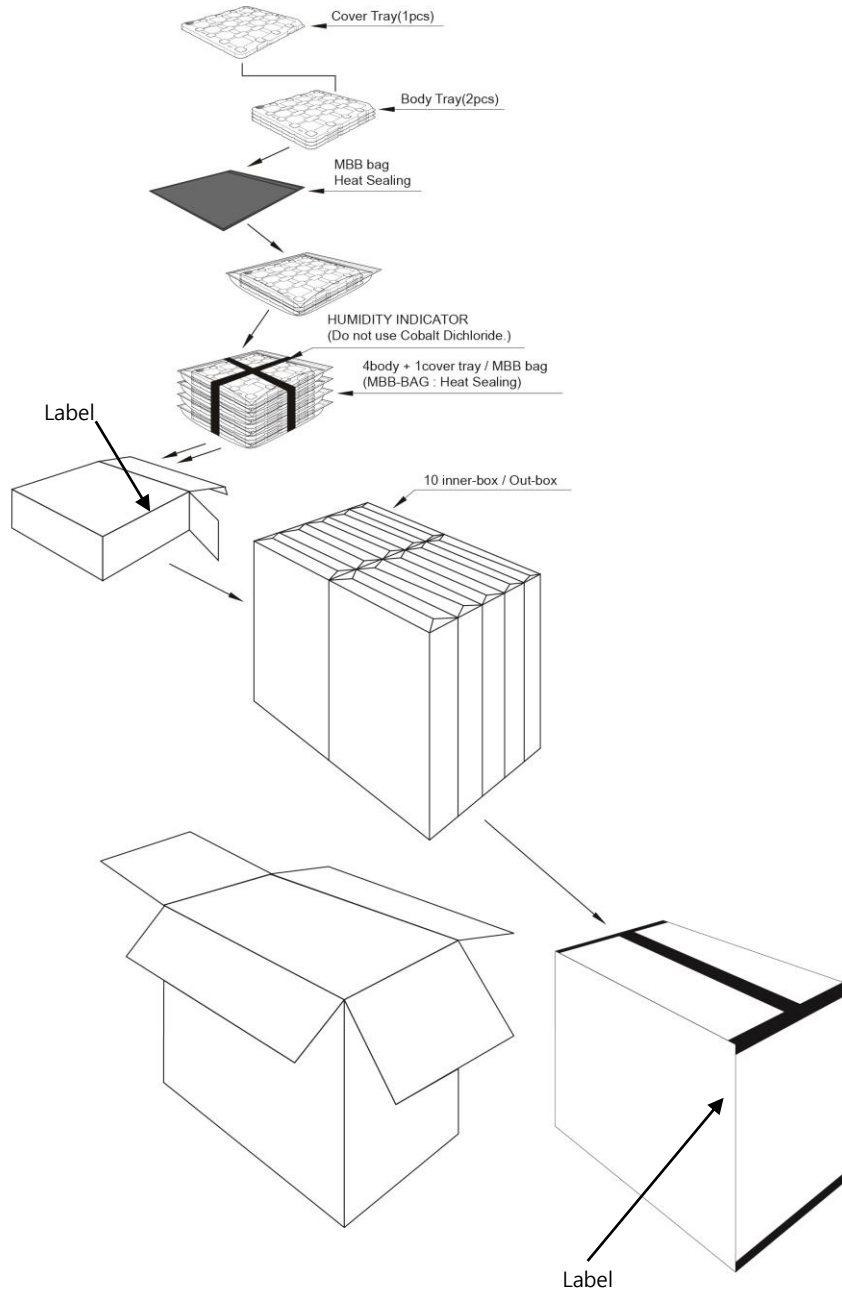

b) Tray

① Cover

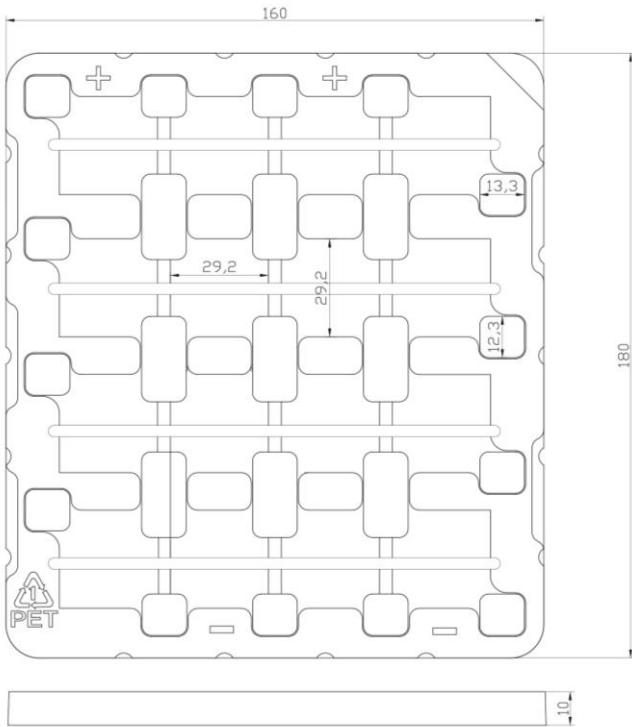

② Body

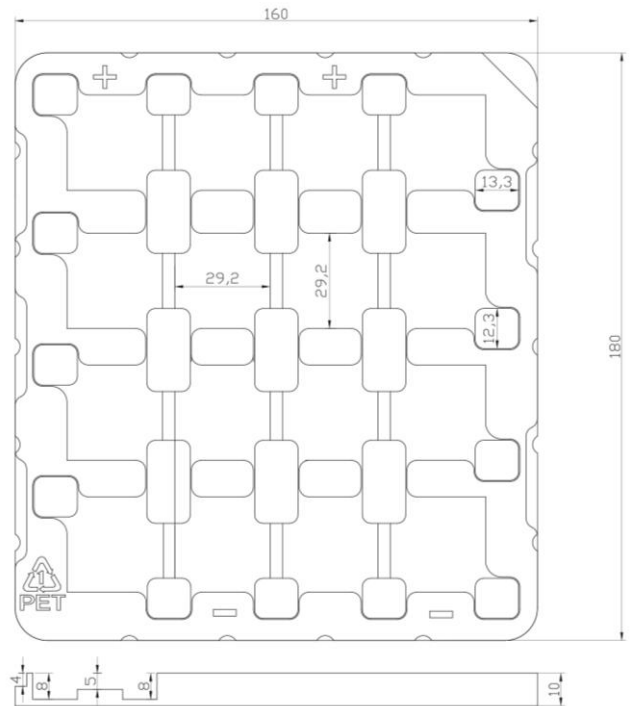

c) Aluminum Vinyl Packing Bag

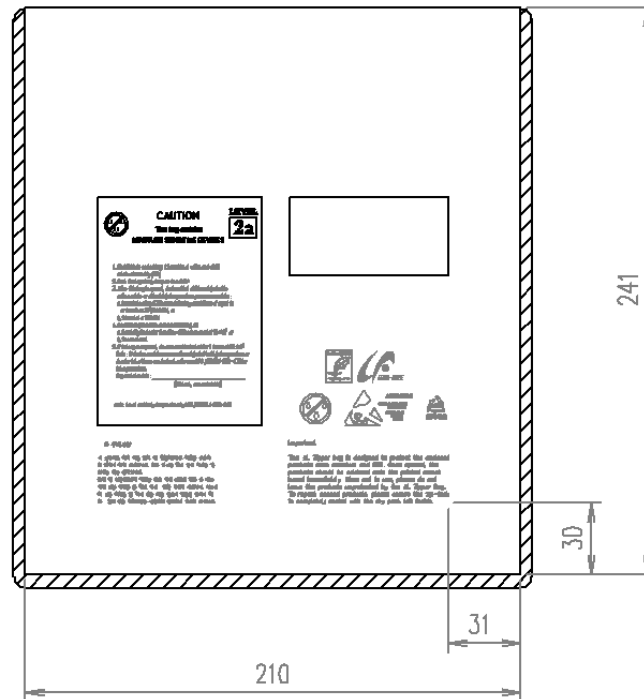



## 8. Precautions in Handling & Use

- 1) This device should not be used in any type of fluid such as water, oil, organic solvent, etc. When cleaning is required, IPA is recommended as the cleaning agent. Some solvent-based cleaning agent may damage the silicone resins used in the device.
- 2) LEDs must be stored in a clean environment. If the LEDs are to be stored for three months or more after being shipped from Samsung, they should be packed with a nitrogen-filled container (shelf life of sealed bags is 12 months at temperature 0~40 °C, 0~90 % RH).
- 3) After storage bag is opened, device subjected to soldering, solder reflow, or other high temperature processes must be:
  - a. Mounted within 672 hours (28 days) at an assembly line with a condition of no more than 30 °C / 60 % RH, or
  - b. Stored at <10 % RH
- 4) Repack unused products with anti-moisture packing, fold to close any opening and then store in a dry place.
- 5) Devices require baking before mounting, if humidity card reading is >60 % at 23 ± 5 °C.
- 6) Devices must be baked for 1 hour at 60 ± 5 °C, if baking is required.
- 7) The LEDs are sensitive to the static electricity and surge current. It is recommended to use a wrist band or anti-electrostatic glove when handling the LEDs. If voltage exceeding the absolute maximum rating is applied to LEDs, it may cause damage or even destruction to LED devices. Damaged LEDs may show some unusual characteristics such as increase in leakage current, lowered turn-on voltage, or abnormal lighting of LEDs at low current.
- 8) The thermal management is one of the most critical factors for the LED lighting system. Especially the LED junction temperature should not exceed the absolute maximum rating while operation of LED lighting system.  
For more information, please refer to Application Note 'Mechanical & Thermal Guide for COB'.
- 9) In case of driving LEDs around the minimum current level ( $I_{f\_min}$ ), chips might exhibit different brightness due to the variation in I-V characteristics of each one. This is normal and does not adversely affect the performance of product.
- 10) VOCs (Volatile Organic Compounds) can be generated from adhesives, flux, hardener or organic additives used in luminaires (fixtures). Transparent LED silicone encapsulant is permeable to those chemicals and they may lead to a discoloration of encapsulant when they exposed to heat or light. This phenomenon can cause a significant loss of light emitted (output) from the luminaires. In order to prevent these problems, we recommend users to know the physical properties of materials used in luminaires and they must be carefully selected.
- 11) The resin area is very sensitive, please do not handle, press, touch, rub, clean, or pick by with tweezers on it. Instead, please pick at the handling area as indicated below.

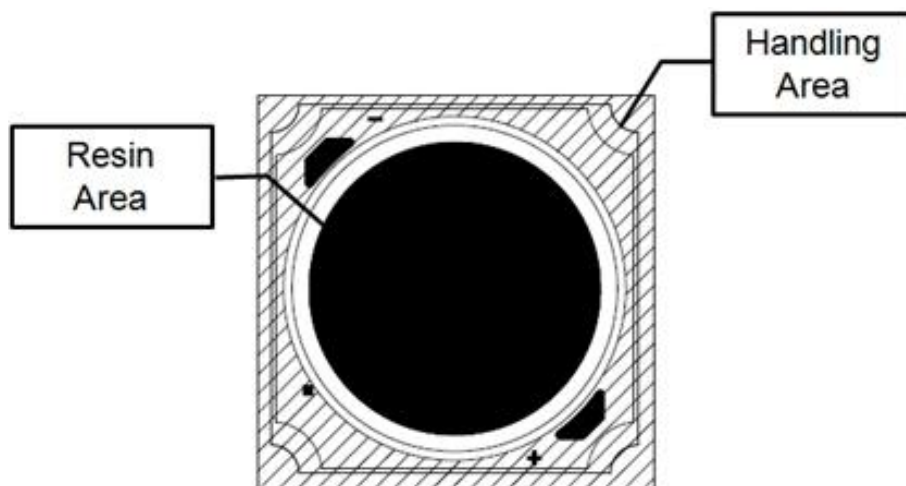

# Legal and additional information.

## [About Samsung Electronics Co., Ltd.](#)

Samsung Electronics Co., Ltd. inspires the world and shapes the future with transformative ideas and technologies, redefining the worlds of TVs, smartphones, wearable devices, tablets, cameras, digital appliances, printers, medical equipment, network systems and semiconductors.

We are also leading in the Internet of Things space through, among others, our Digital Health and Smart Home initiatives. We employ 307,000 people across 84 countries. To discover more, please visit our official website at [www.samsung.com](http://www.samsung.com) and our official blog at [global.samsungtomorrow.com](http://global.samsungtomorrow.com).

Copyright © 2015 Samsung Electronics Co., Ltd. All rights reserved.

Samsung is a registered trademark of Samsung Electronics Co., Ltd.

Specifications and designs are subject to change without notice. Non-metric weights and measurements are approximate. All data were deemed correct at time of creation. Samsung is not liable for errors or omissions. All brand, product, service names and logos are trademarks and/or registered trademarks of their respective owners and are hereby recognized and acknowledged.

Samsung Electronics Co., Ltd.  
95, Samsung 2-ro  
Giheung-gu  
Yongin-si, Gyeonggi-do, 446-711  
KOREA

[www.samsungled.com](http://www.samsungled.com)

**SAMSUNG**