

## Specification

- Part No. : **SDDCP.5900.25.10.A.08**
- Product Name : Embedded 25\*25\*10.15mm Stacked SDARS & C-V2X Patch Antenna for OEM Automotive Applications
- Feature : SDARS & C-V2X Stacked patch antenna  
High Efficiency and Gain  
SDARS: LHCP 80.3% Efficiency, +5.4 dBi Gain @2332.5MHz  
C-V2X: RHCP 68.5% Efficiency, +3.5dBi Gain @5900MHz  
Dual Feed Patch Assembly  
Tuned for Centre Positioning on 70\*70mm Ground Plane  
Through-Hole Mounting Pin Type  
Manufactured in an IATF 16949 certified facility  
Dimensions: 25x25x10mm  
RoHS & REACH Compliant



## 1. Introduction

The SDDCP.5900.25.10.A.08 is a passive embedded ceramic stacked patch antenna with both SDARS and C-V2X capabilities. Using a stacked dual patch assembly for both bands results in the most economical and space-efficient solution for demanding applications requiring both SDARS and C-V2X. The patch assembly is easy to integrate with an overall footprint size of just 25x25mm and sits at 10.15mm in height.

The SDARS patch at 25mm\*25mm is designed for use with Satellite Digital Audio Radio Services (SDARS). It features left-hand circular polarization, low in-band axial ratio, and excellent gain characteristics in the 2320 to 2345 MHz band, making it compatible with the most popular satellite radio services available in many new vehicles. It is extremely efficient with up to 80% efficiency at 2332.5MHz.

The C-V2X patch at 12mm\*12mm is used as the communications medium of choice for active safety V2V/C-V2X (Vehicle-to-Vehicle and Vehicle-to-Other) or DSRC (Dedicated Short Range Communications) systems. Primarily allocated for vehicle safety applications, C-V2X supports high-speed, low-latency, DSRC, V2V/C-V2X wireless communications. The C-V2X patch also has left hand circular polarization and nearly 70% efficiency at 5900MHz.

A typical use case would include utilizing the stacked patch in shark fin style external automotive roof mounted antennas.

This antenna has been tuned and tested on a 70 x 70 mm ground plane. Custom tuning services can be provided for further optimization to customer-specific device environments. Note that certification of your device and/or the antenna may be required by certain Satellite Radio providers. Further engineering may be needed to meet their requirements. Contact your regional Taoglas sales office for support.

## 2. Specification

Electrical	
Frequency	SDARS: 2320 ~ 2345 MHz C-V2X : 5850 ~ 5925 MHz
Centre Frequency	SDARS: 2332.5 ± 3 MHz C-V2X : 5887.5 ± 3 MHz
Return Loss	SDARS: -10dB max. C-V2X: -10dB max.
Zenith Gain	SDARS: +5.4 dBi typ. C-V2X: +3.5 dBi typ.
Efficiency	SDARS: 80.3 % C-V2X: 68.5 %
Axial Ratio	SDARS: 18.4 dB typ. C-V2X: 14.4 dB typ.
Polarization	L.H.C.P. For SDARS R.H.C.P. For C-V2X
Impedance	50 Ω
Mechanical	
Dimensions	25 x 25 x 10.15mm SDARS: 25 x 25 x 6 mm C-V2X: 12 x 12 x 4 mm
Material	Ceramic
Pin Diameter	0.8mm
Pin Length	2.0mm
Weight	13.9g
Environmental	
Operation Temperature	-40°C to +85°C
Humidity	Non-condensing 65°C 95% RH

\* Antenna properties were measured with the antenna mounted on 70\*70mm Ground Plane



### 3. Antenna Characteristics

#### 3.1 Return Loss

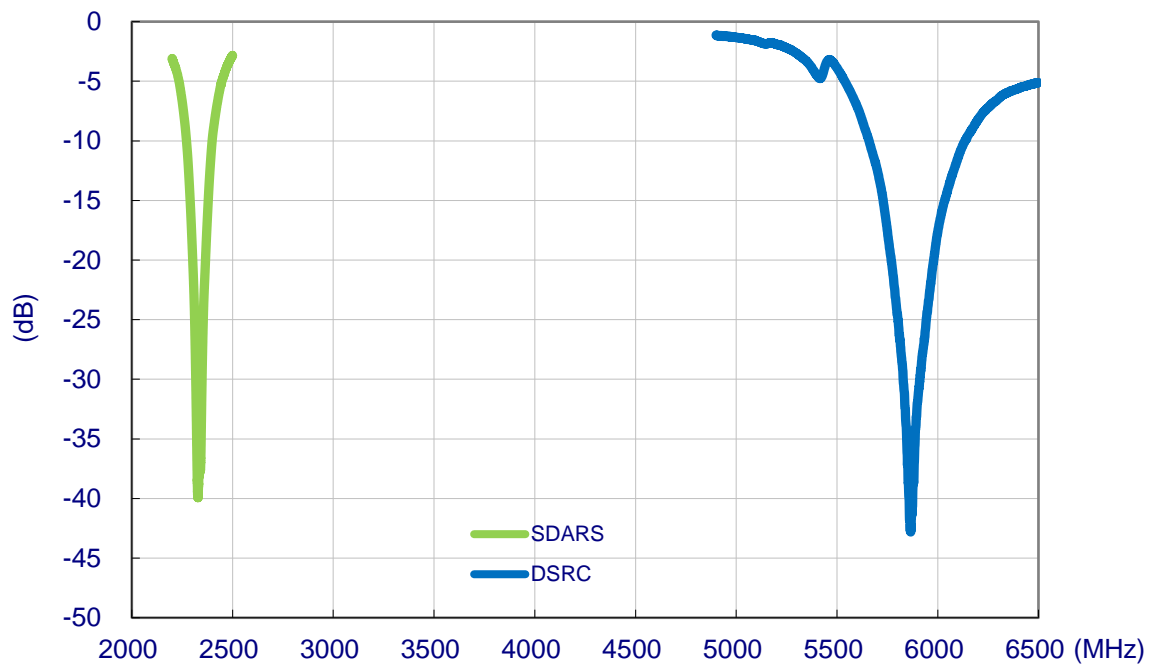

#### 3.2 Efficiency

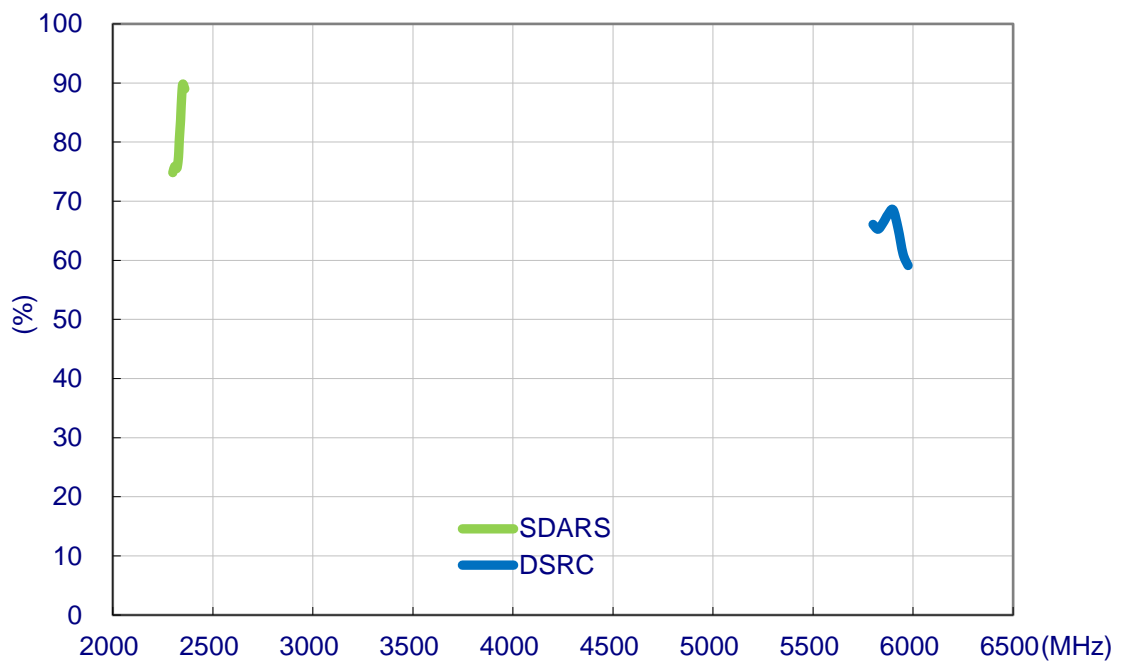

### 3.3 Average Gain

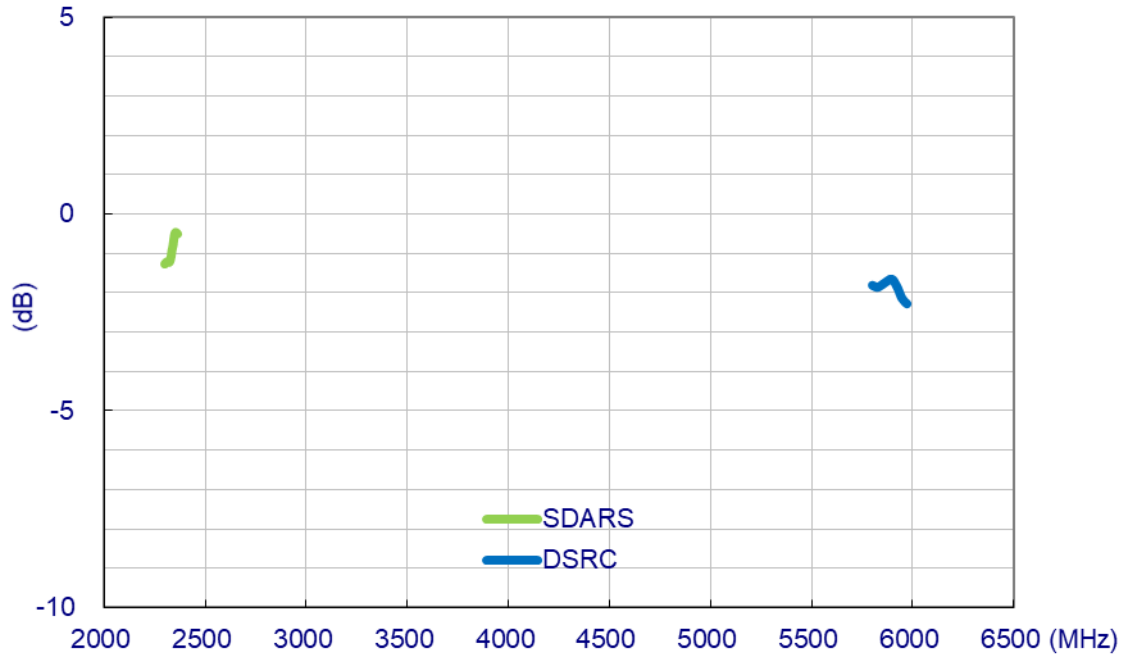

### 3.4 Peak Gain

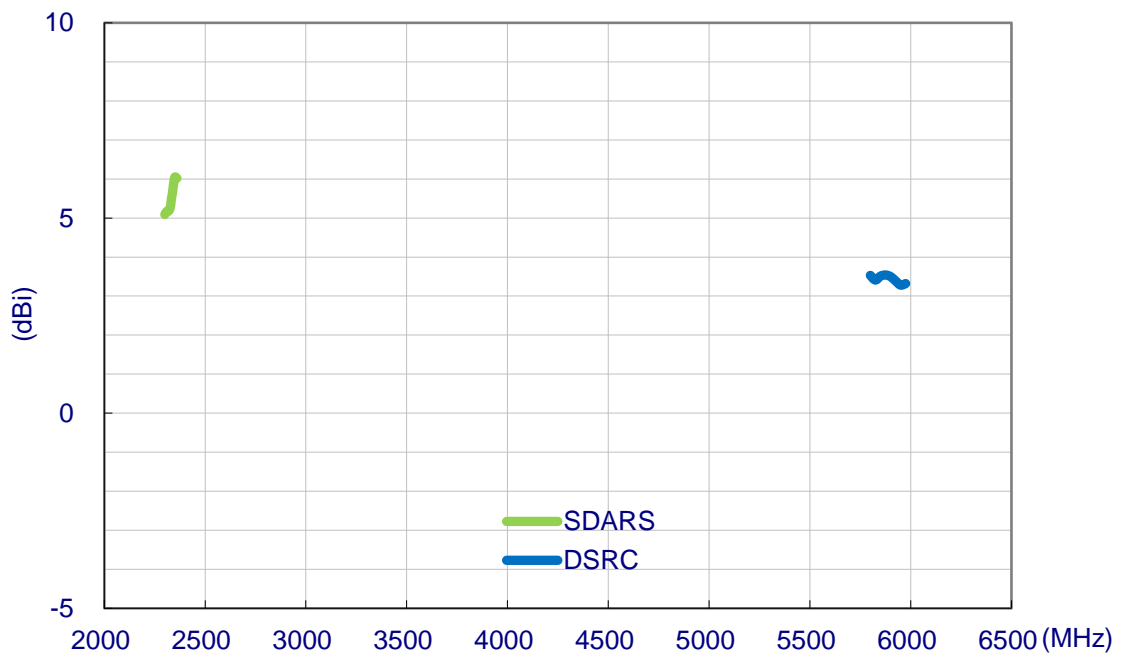

### 3.5 Axial Ratio (Zenith is at 0° )

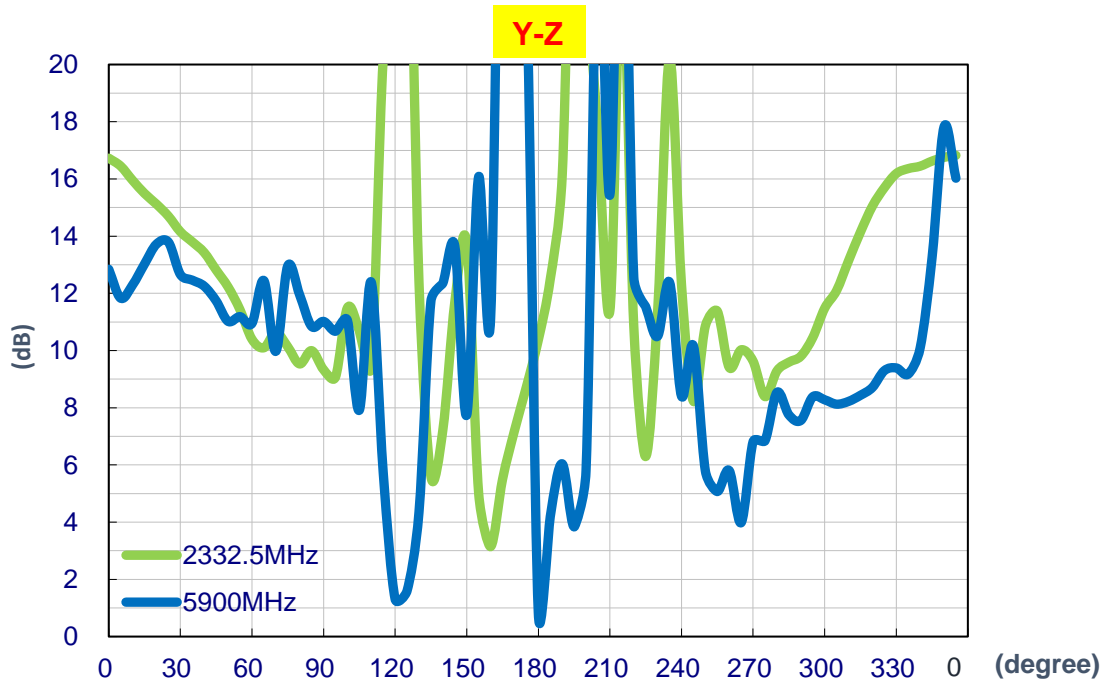
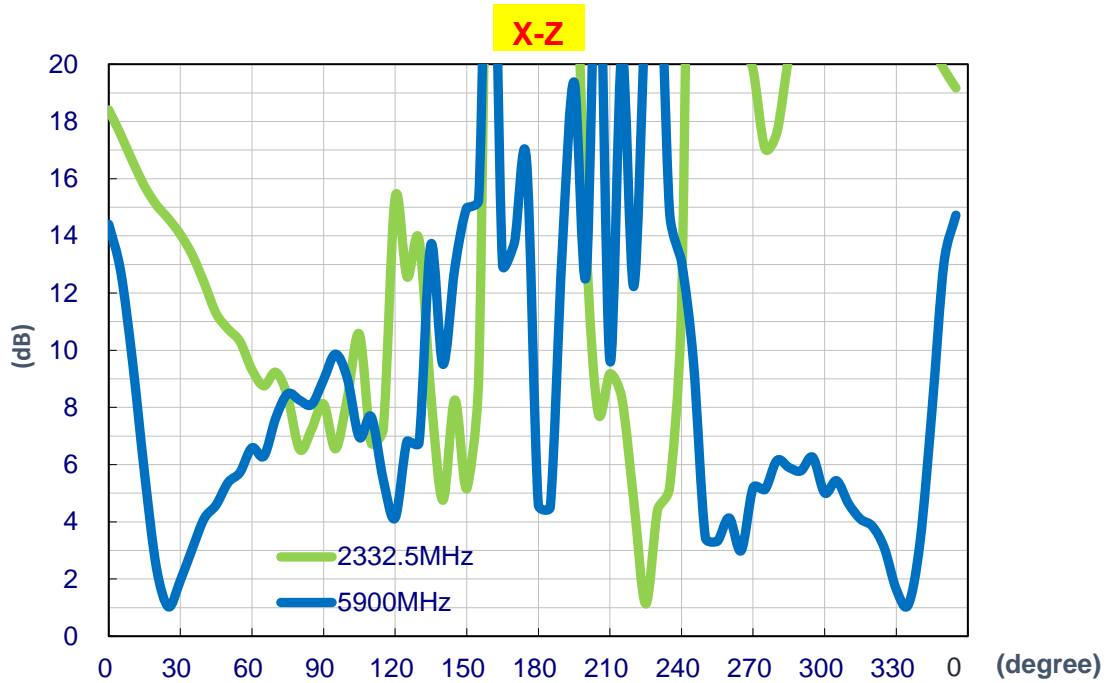

### 3.6 Isolation

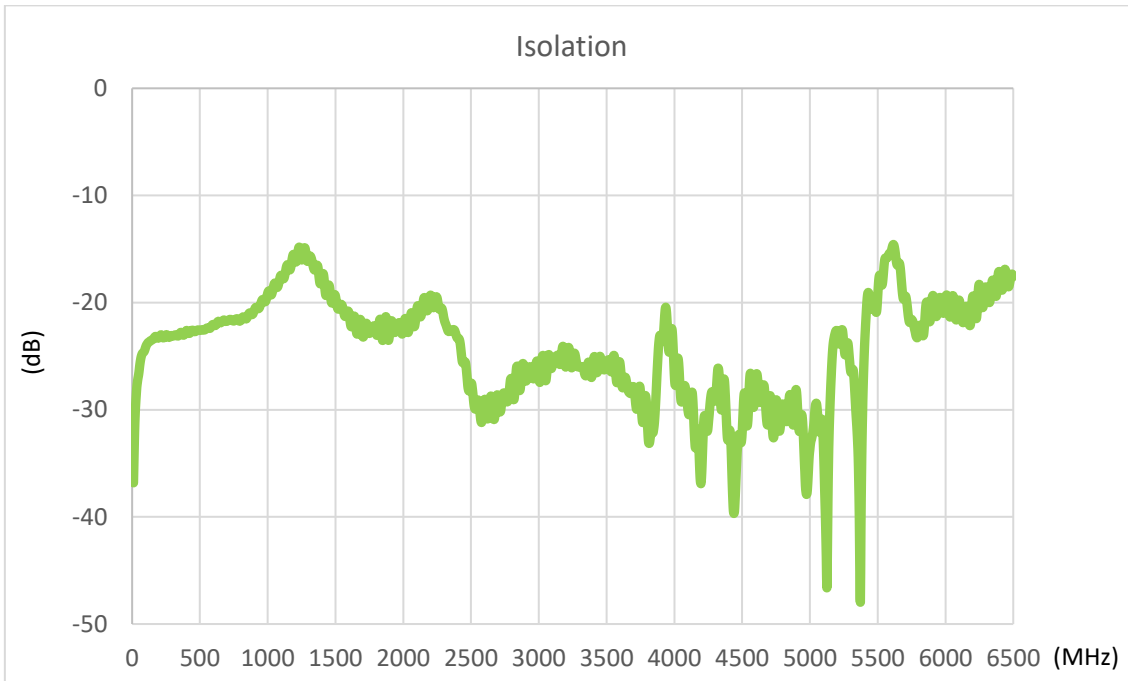

### 3.7 XM Gain Requirements (Satellite) – Ground Plane

AUT Location	Elevation Angle(degrees)	Linear Average Gain(dBic)
Passive Ground Plane	$20 \leq \phi \leq 25$	-1.1
	$25 \leq \phi \leq 30$	-0.5
	$30 \leq \phi \leq 50$	1.1
	$50 \leq \phi \leq 70$	3.2
	$70 \leq \phi \leq 90$	4.2

### XM Gain Requirements (Terrestrial) – Ground Plane

AUT Location	Elevation Angle(degrees)	Antenna Mean Passive VP Gain Over Solid Angle (dBi)	Antenna P/P Gain variation (dB)
Passive Ground Plane	$0^\circ \leq \phi \leq 10^\circ$	-7.0	-
	$\phi = 5^\circ$	-	6.1

## 4. Antenna Radiation Pattern

### 4.1 Measurement Setup

The SDDCP.5900.25.10.A.08 antenna is tested with 70X70mm ground plane in a CTIA certified Anechoic Chamber. The test setup is shown below.

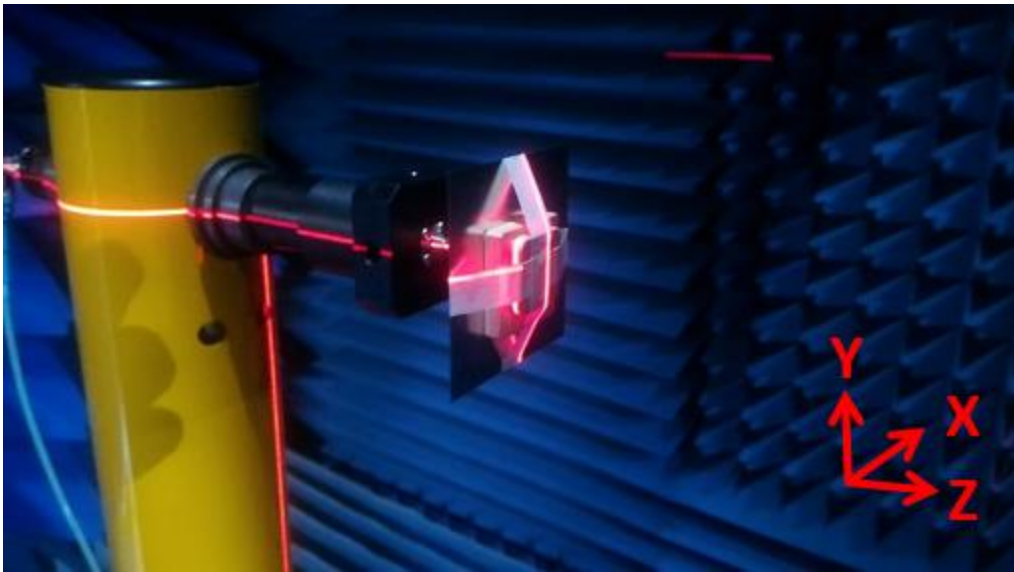



## 4.2 2D Radiation Pattern

### X-Y Plane

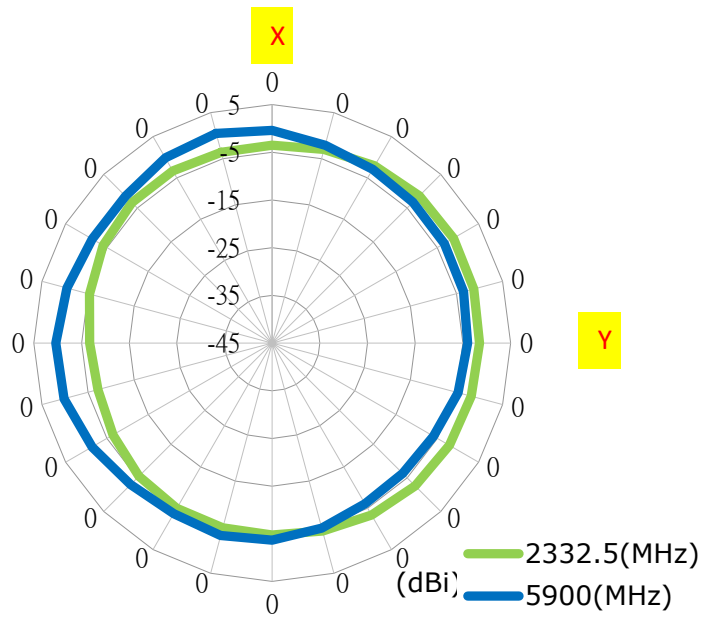

### X-Z Plane

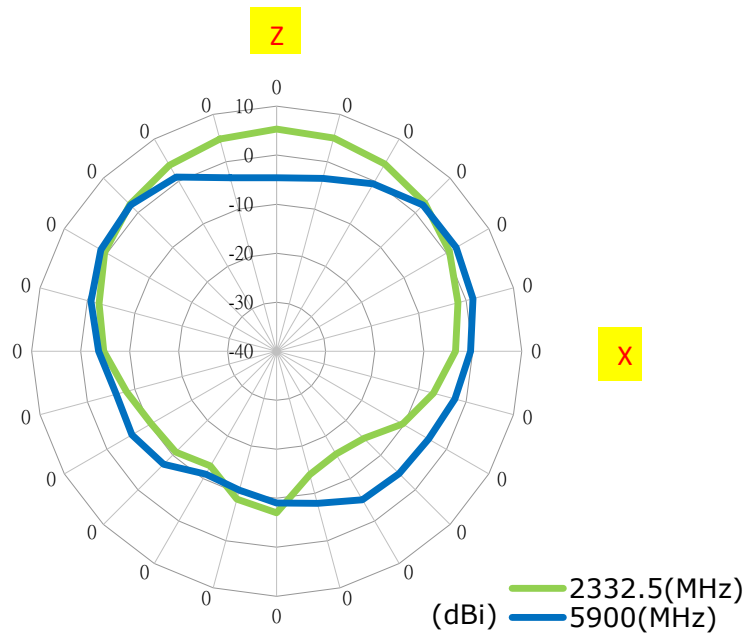

## Y-Z Plane

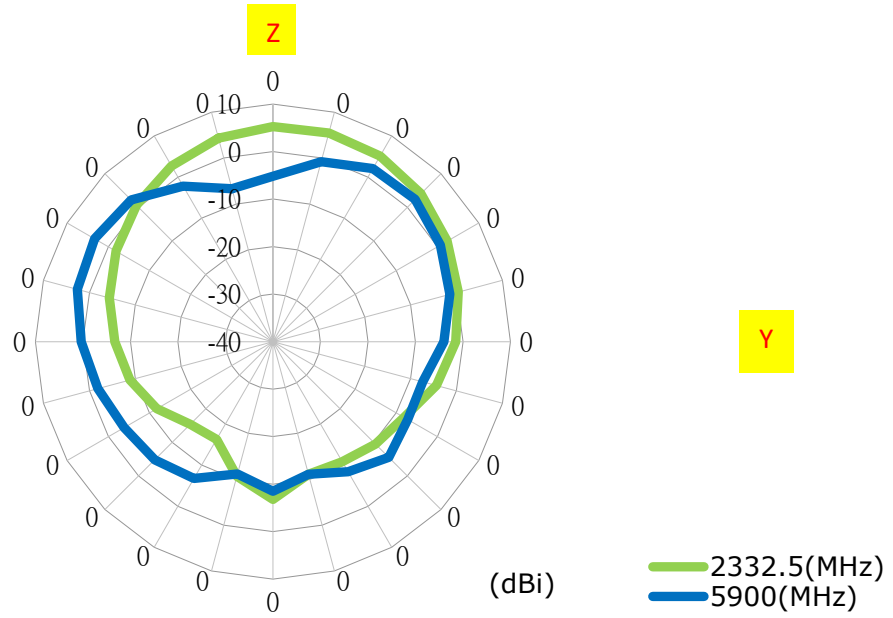

## 5. 3D Radiation Pattern

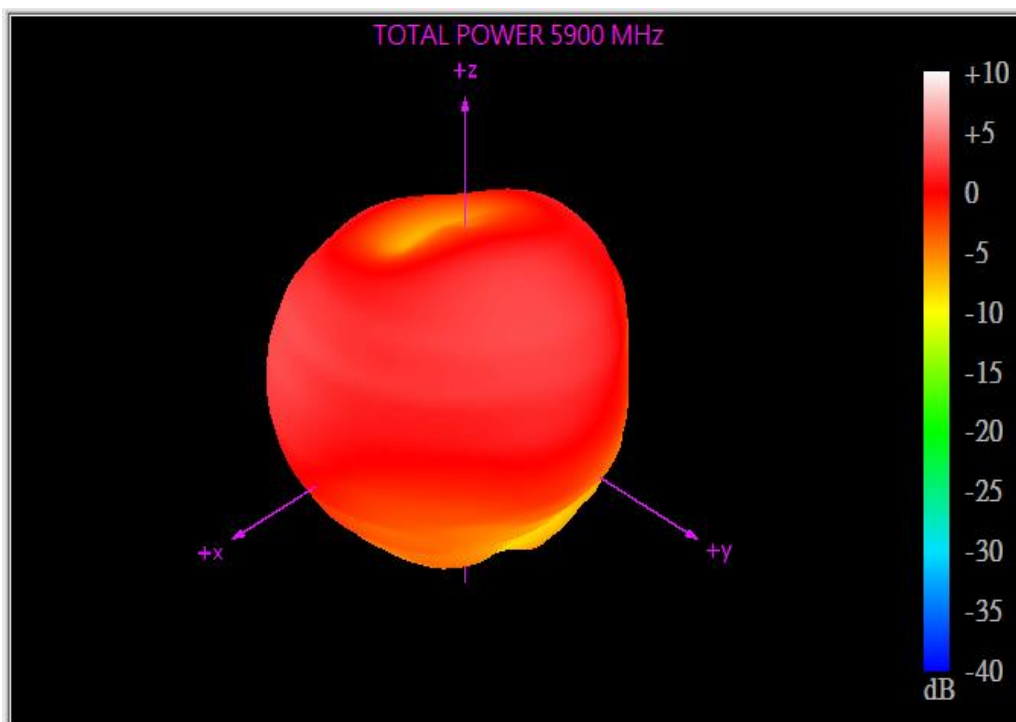
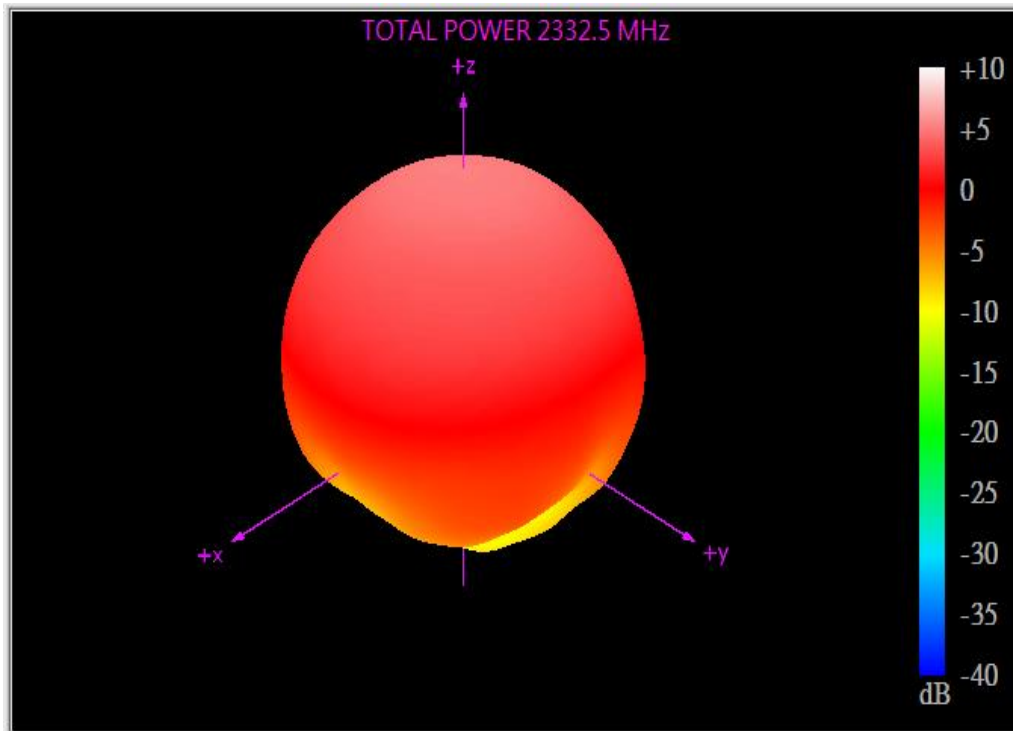

## 6. Mechanical Drawing (Unit:mm)

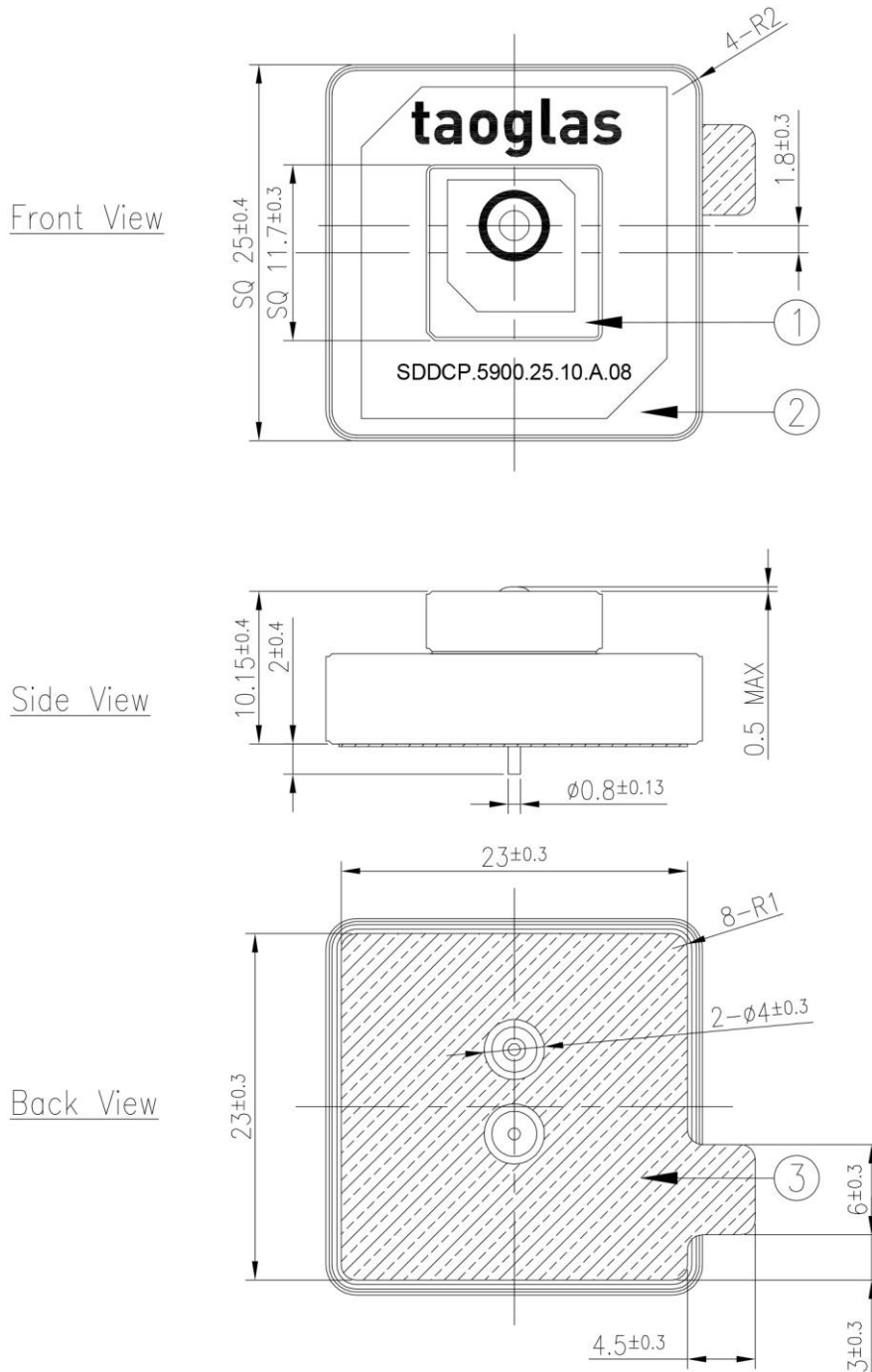

	Name	Material	Finish	QTY
1	Patch-1 (12x12x4mm)	Ceramic	Clear	1
2	Patch-2 (25x25x6mm)	Ceramic	Clear	1
3	Double Sided Adhesive	NITTO 5015	White Liner	1

## 7. Recommended Pin Feed Pad Layout

(Unit:mm)

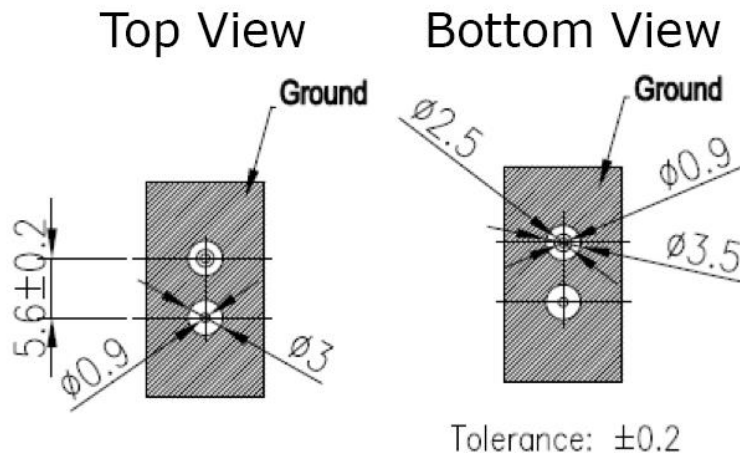

## 8. Evaluation Board (Unit:mm)

### SDDCPD.5900.25.10.A.08

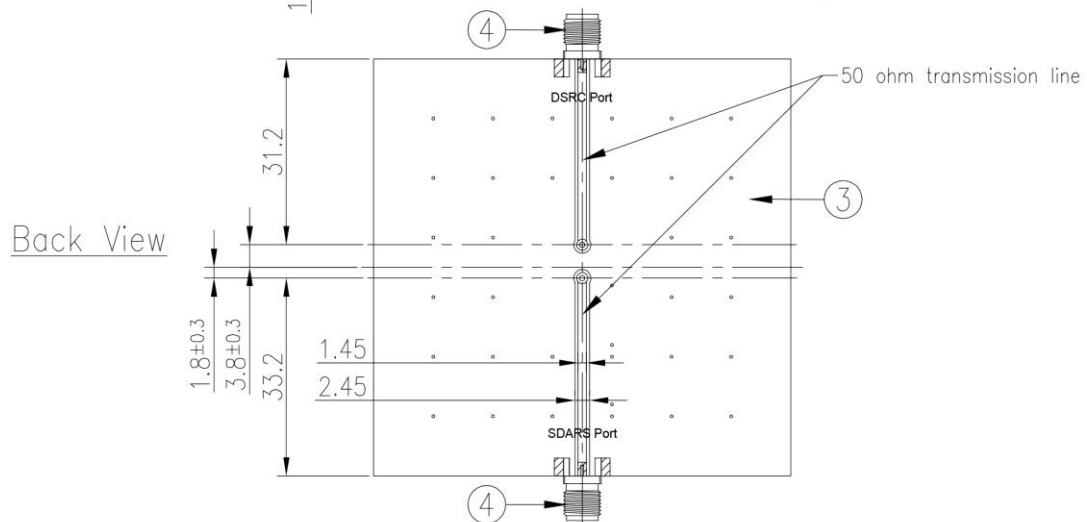
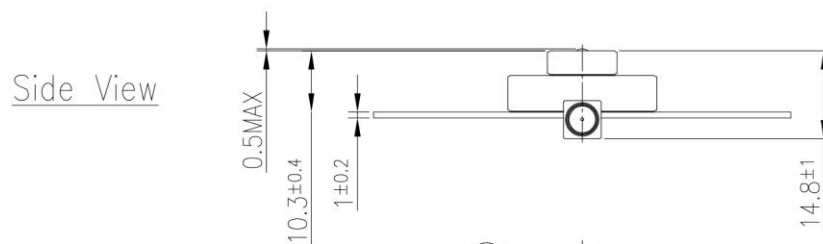
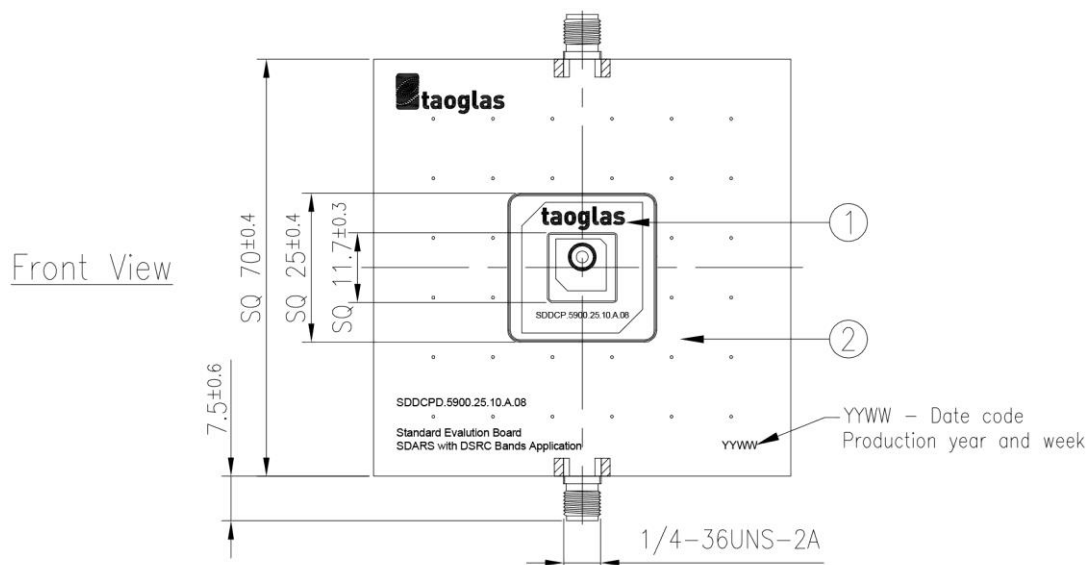

	Name	Material	Finish	QTY
1	Patch-1 (12x12x4mm)	Ceramic	Clear	1
2	Patch-2 (25x25x6mm)	Ceramic	Clear	1
3	PCB	Composite 1t	Black	1
4	SMA(F)ST	Brass	Au Plated	2

## 9. Packaging

30 pcs SDDCP.5900.25.10.A.08 per Tray  
 Tray Dimensions - 300\*370\*30mm  
 Weight - 596g

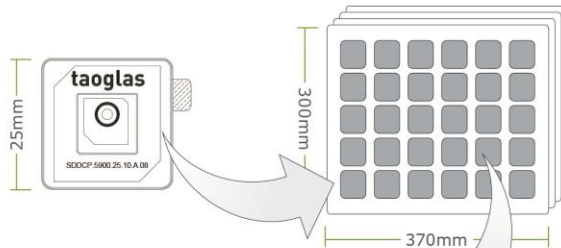

120 pcs SDDCP.5900.25.10.A.08 per Vacuum Bag  
 Vacuum Bag Dimensions - 300\*370\*50mm  
 Weight - 2.4kg

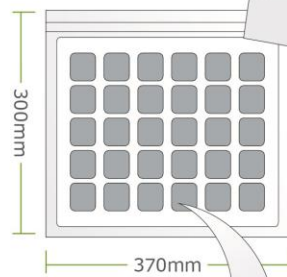

360 pcs GPSDSF.35.7.A.08 per Carton  
 Carton Dimensions - 390\*320\*270mm  
 Weight - 10.05kg

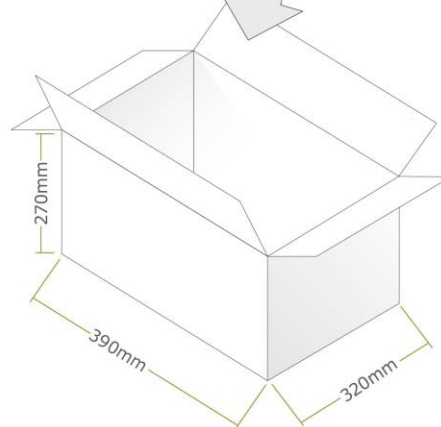

Pallet Dimensions:  
 1200mm\*1000mm\*1280mm  
 36 Cartons per Pallet  
 9 Cartons per Layer, 4 Layers

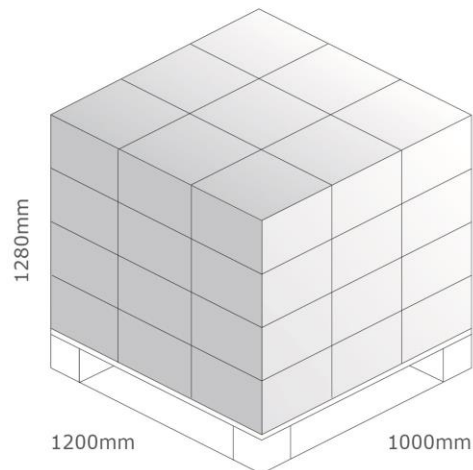



Taoglas makes no warranties based on the accuracy or completeness of the contents of this document and reserves the right to make changes to specifications and product descriptions at any time without notice.

Taoglas reserves the rights to this document and the information contained herein. Reproduction, use or disclosure to third parties without express permission is strictly prohibited.

© Taoglas